

alea

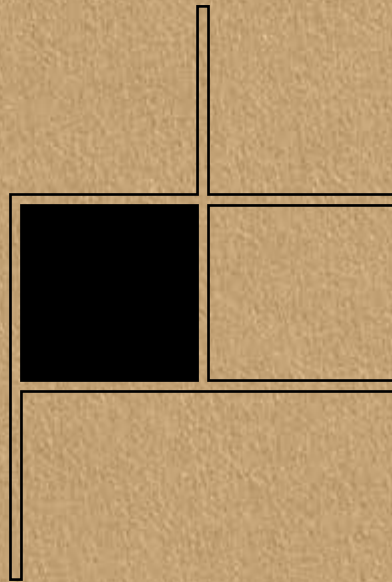

Q18

modular bookshelves

ABC di Q18

Sistema di fissaggio
intelligente e ampia
gamma di colori.

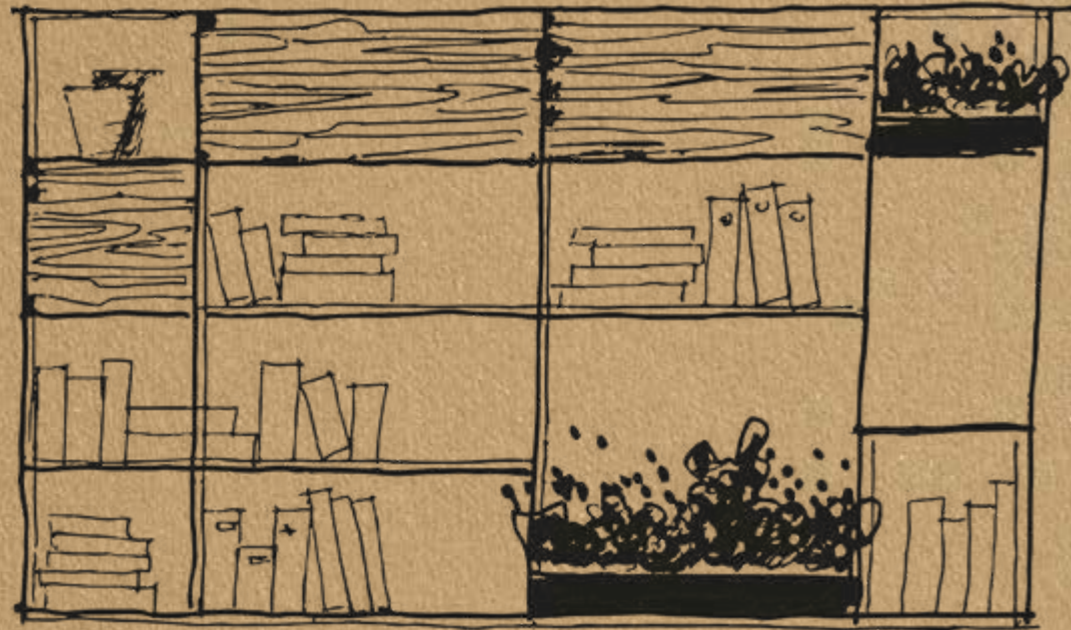

Smart fixing system
and wide range of
colours

Système de fixation
intelligent et large
gamme de couleurs

Sistema de fijación
inteligente y amplia
gama de colores

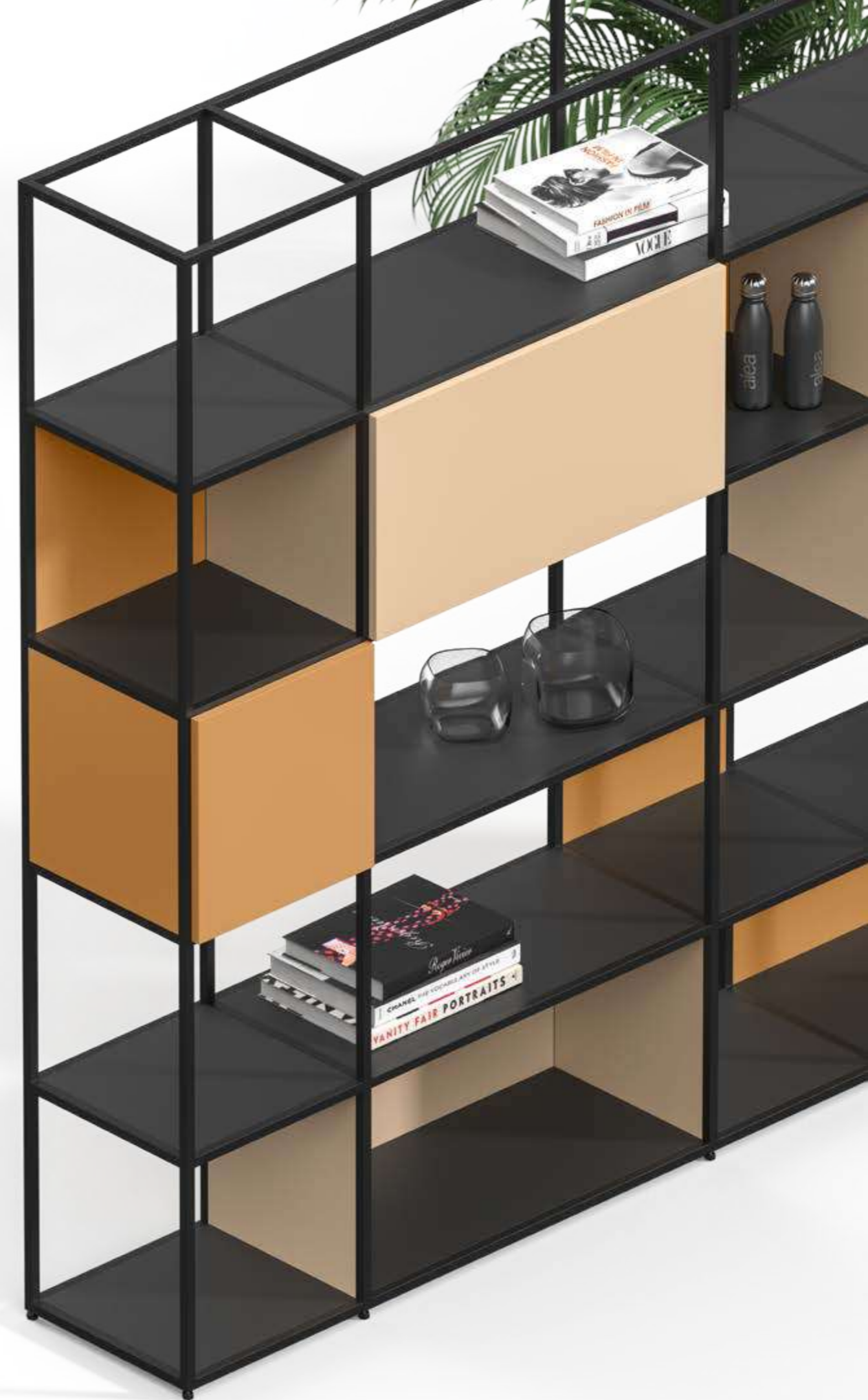

Unicità

Il design unico del sistema di librerie Q18, è l'equilibrio perfetto tra complanarità dei componenti, libertà di layout e molteplici opzioni di colore. Sottile, elegante e personalizzabile, questo è Q18.

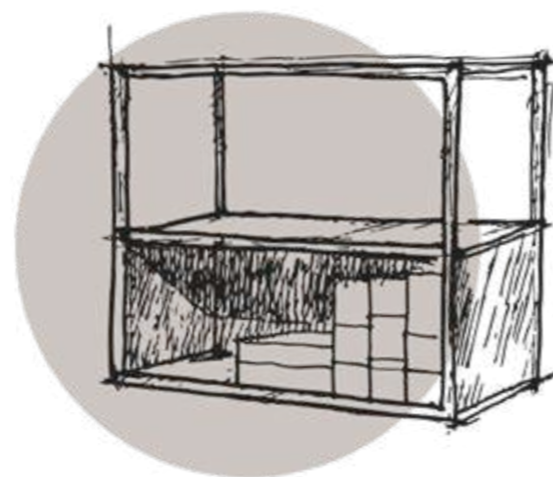

Uniqueness The unique design of the Q18 shelving system is the perfect balance between flushness of components, layout freedom and multiple colour options. Thin, elegant and customizable, this is Q18.



Unicité Le design unique du système d'étagères Q18 est l'équilibre parfait entre la fluidité des composants, la liberté d'agencement et les multiples options de couleurs. Mince, élégant et personnalisable, c'est le Q18.

Único El diseño único de la estantería Q18 es el equilibrio perfecto entre la coplanaridad de los componentes, la libertad de distribución y las múltiples opciones de color. Fino, elegante y personalizable, este es Q18.

Minimalismo intelligente

Q18 è una soluzione modulare composta da una struttura in tubolare di alluminio con sezione 18x18 mm, alla quale vengono integrati pannelli e moduli contenitori. Il sistema di fissaggio intelligente che unisce le parti in alluminio rende questo prodotto elegante e pulito, senza viti a vista.



Smart minimalism Q18 is a modular solution consisting of a tubular aluminium structure with 18x18 mm section, to which panels and container modules are integrated. The intelligent fixing system that combines the aluminium parts makes this product elegant and clean, without visible screws.

Minimalisme intelligent Q18 est une solution modulaire constituée d'une structure tubulaire en aluminium de section 18x18 mm, à laquelle sont intégrés des panneaux et des modules de conteneurs. Le système de fixation intelligent qui combine les pièces en aluminium rend ce produit élégant et propre, sans vis apparentes.

Minimalismo inteligente Q18 es una solución modular que consiste en una estructura tubular de aluminio de sección 18x18 mm, a la que se integran paneles y módulos de contenedores. El sistema de fijación inteligente que combina las piezas de aluminio hace que este producto sea elegante y limpio, sin tornillos visibles.



Modularità

Q18 è pensato per rispondere alle più svariate esigenze d'arredo. Per i moduli si può scegliere infatti tra 8 diverse larghezze, 3 profondità e 2 altezze. Schiene e fianchi possono essere sostituiti da tiranti in acciaio che sostengono la struttura conferendole anche un'alternativa estetica.



Modularity Q18 is designed to meet the most varied furnishing requirements. For the modules you can choose between 8 different widths, 3 depths and 2 heights. Back and sides can be replaced by steel tie rods that support the structure, giving it an aesthetic alternative.

Modularité Q18 est conçu pour répondre aux besoins d'ameublement les plus variés. Pour les modules, vous pouvez choisir entre 8 largeurs différentes, 3 profondeurs et 2 hauteurs. Le dos et les côtés peuvent être remplacés par des tirants en acier qui soutiennent la structure, ce qui lui donne une alternative esthétique.

Modularidad Q18 está diseñado para satisfacer las más variadas necesidades de mobiliario. Para los módulos se puede elegir entre 8 anchos diferentes, 3 profundidades y 2 alturas. La parte trasera y los laterales pueden ser sustituidos por tirantes de acero que soportan la estructura, dándole una alternativa estética.

LAYOUT

Endless
layout
possibilities:
hints and
notes

**Infinite
possibilità
di layout:
spunti e
appunti**

Infinitas
posibilidades
de diseño:
consejos y
notas

Infinies
possibilités
de layout:
conseils et
notes





Elements Q18 compositions can be integrated with different types of elements. Shelves, backs, sides, drawer units, container modules with hinged and flap doors, planter boxes can be added to the structure to better adapt to the practical needs of users.

Éléments Les compositions du Q18 peuvent être intégrées avec différents types d'éléments. Des étagères, des dossiers, des côtés, des tiroirs, des modules de conteneurs avec des portes à charnières et à rabat, des plateaux à plantes peuvent être ajoutés à la structure pour mieux s'adapter aux besoins pratiques des utilisateurs.

Elementos Las composiciones Q18 pueden ser integradas con diferentes tipos de elementos. Estantes, respaldos, laterales, cajoneras, módulos contenedores con puertas batientes y abatibles, bandejas para plantas se pueden añadir a la estructura para adaptarse mejor a las necesidades prácticas de los usuarios.

Elementi

Le composizioni Q18 si possono integrare con diverse tipologie di elementi. Ripiani, schiene, fianchi, cassettiere, moduli contenitori con ante battenti e a ribalta, vaschette porta piante possono essere aggiunti alla struttura per meglio adattarsi alle esigenze pratiche degli utilizzatori.



Opzioni

In base all'altezza e alla profondità scelta, Q18 si può utilizzare come sistema indipendente, piuttosto che fissato al muro oppure al soffitto. Anche l'appoggio a terra è disponibile in diverse opzioni: piedini bassi o rialzati oppure su ruote. Le ante dei contenitori sono progettate con sistema di apertura "push and pull" per marcarne ulteriormente il design minimalista.



Options Depending on the height and depth chosen, Q18 can be used as a stand-alone system, rather than fixed to the wall or ceiling. The floor support is also available in different options: low or raised feet or on castors. Closed storage is fitted with push-pull closures so no handles are required maintaining a clean aesthetic.



Options Selon la hauteur et la profondeur choisies, Q18 peut être utilisé comme un système autonome, plutôt que d'être fixé au mur ou au plafond. Le support au sol est également disponible en différentes options: pieds bas ou surélevés ou sur roulettes. Les portes des conteneurs sont conçues avec un système d'ouverture par poussée et traction pour marquer davantage leur conception minimaliste.

Opciones Dependiendo de la altura y la profundidad elegidas, Q18 puede utilizarse como un sistema autónomo, en lugar de fijarse a la pared o al techo. El apoyo al suelo también está disponible en diferentes opciones: pies bajos o elevados o sobre ruedas. As puertas de los contenedores están diseñadas con un sistema de apertura de empujar y tirar para marcar aún más su diseño minimalista.





Libertà di layout

Questa collezione ha la capacità di adattarsi a qualsiasi tipo di ambiente e soluzione d'arredo. Quasi nessun limite alla creatività, con soluzioni lineari o articolate che permettono di ottenere le più svariate geometrie.



Layout freedom This collection has the ability to adapt to any type of environment and furnishing solution. Almost no limits to creativity with linear runs or returns also incorporating worksurfaces at desk or standing height.

Liberté de configuration Cette collection a la capacité de s'adapter à tout type d'environnement et de solution d'ameublement. Presque aucune limite à la créativité, avec des solutions linéaires ou articulées qui permettent d'obtenir les géométries les plus variées.

Libertad de configuración Esta colección tiene la capacidad de adaptarse a cualquier tipo de entorno y solución de mobiliario. Casi sin límites a la creatividad, con soluciones lineales o articuladas que permiten obtener las más variadas geometrías.



La struttura di Q18 si adatta ad allestire gli interni spingendosi fino a diventare un vero e proprio elemento divisorio che può includere soluzioni a ponte.

The structure of Q18 can be adapted to fit out interiors and even become a real partition element that can include bridge solutions.

La structure de Q18 peut être adaptée aux intérieurs et peut même devenir un véritable cloison qui peut inclure des solutions de pont.

La estructura de Q18 puede adaptarse a los interiores e incluso convertirse en un verdadero elemento de separación que puede incluir soluciones de puente.



Spazi ibridi

Q18 si adatta perfettamente alla creazione dei sempre più indispensabili spazi ibridi. In particolar modo i pannelli scrivibili svolgono non solo la funzione strutturale ma si possono utilizzare come lavagna per la condivisione delle idee.

Q18 is perfectly suited to the creation of increasingly indispensable hybrid spaces. In particular, the writable panels not only perform a structural function but can also be used as a whiteboard for sharing ideas.

Q18 est parfaitement adapté à la création d'espaces hybrides de plus en plus indispensables. En particulier, les panneaux inscriptibles n'ont pas seulement une fonction structurelle, mais ils peuvent également être utilisés comme tableau blanc pour partager des idées.

Q18 se adapta perfectamente a la creación de los cada vez más indispensables espacios híbridos. En concreto, los paneles escribibles no sólo cumplen una función estructural, sino que también pueden utilizarse como pizarra para compartir ideas.



Palette di colori

l'ampia gamma di finiture e colori disponibili è il tocco finale. 18 diverse opzioni melaminiche per gli elementi pannellati, da abbinare alla struttura in metallo (in 16 diverse vernici epossidiche) per creare il miglior progetto personalizzato.



Colour palette The wide range of finishes and colours available is the finishing touch. 18 different melamine options for the panelled elements, to be combined with the metal structure (in 16 different epoxy paints) to create the best custom design.

Palette de couleurs La large gamme de finitions et de couleurs disponibles est la touche finale. 18 options différentes de mélamine pour les éléments lambrissés, à combiner avec la structure métallique (dans 16 peintures époxy différentes) pour créer le meilleur design personnalisé.

Paleta de colores La amplia gama de acabados y colores disponibles es el toque final. 18 opciones diferentes de melamina para los elementos panelados, que se pueden combinar con la estructura metálica (en 16 pinturas epoxídicas diferentes) para crear el mejor diseño personalizado.



EPX pag.38

Struttura in alluminio verniciato
Epoxy painted aluminium structure
Structure en aluminium peinte
Estructura de aluminio pintado

Sezione quadrata 18x18 mm
Square section 18x18 mm (11/16")
Section carrée 18x18 mm
Sección cuadrada 18x18 mm



MEL pag.37

Pannelli
Panels
Panneaux
Paneles

Schiene e fianchi

disponibili anche nella versione con tiranti in metallo
Backs and sides also available in the version with metal tie rods
Dos et hanches également disponible dans la version avec tirants métalliques
Traseras y laterales: también disponibles en la versión con tirantes metálicos

Supporto 1. piedino esagonale (18 mm), 2. piedino esagonale rialzato (82 mm), 3. ruota (Ø 40 mm)
Support: 1. hexagonal foot (18 mm - 11/16"), 2. raised hexagonal foot (82 mm - 3 1/4"), 3. castor (Ø 40 mm - 1 9/16")
Support: 1. pied hexagonal (18 mm), 2. pied hexagonal relevé (82 mm), 3. roulette (Ø 40 mm)
Soporte: 1. pie hexagonal (18 mm), 2. pie hexagonal elevado (82 mm), 3. rueda (Ø 40 mm)



#01

Schiene/fianchi anche scrivibili
Backs/sides also writable
Fonds/cotés aussi à écrire
Traseras/costados también para escribir

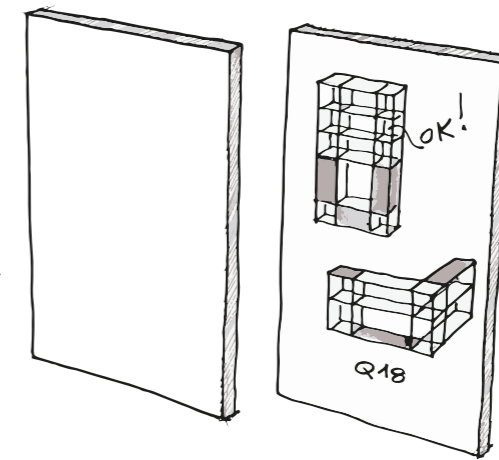

#02

Ripiani
Shelves
Tablettes
Estantes

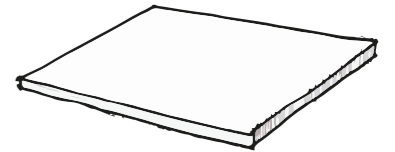

#03

Vani con anta battente o a ribalta anche scrivibili con sistema di apertura "push and pull"
Units with hinged or flap door also writable with "push and pull" opening system
Rangements avec portes battantes ou abattantes pouvant servir d'écritoire avec système d'ouverture "push and pull"
Módulos con puerta batiente o plegable también para escribir con sistema de apertura "push and pull"

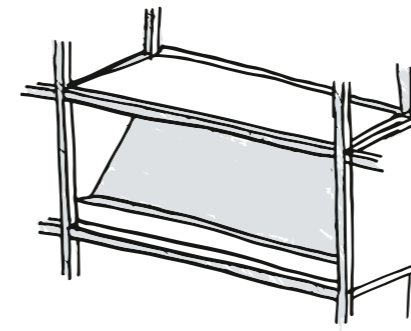
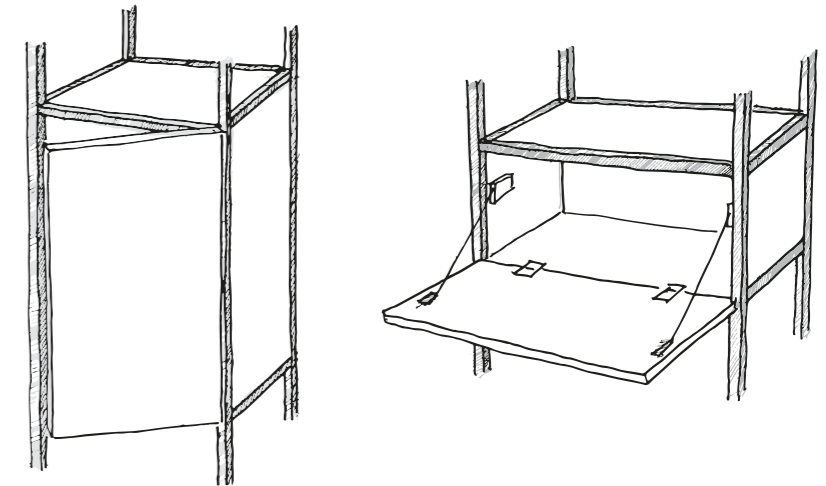

#04

Portariviste
Magazine holder
Porte-revues
Revistero

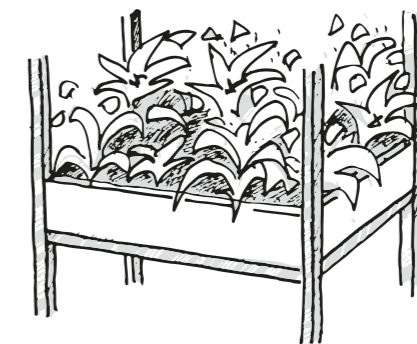

#05

Vaschette porta piante
Plant trays
Vases à plantes
Jardineras

#06

Cassetti/classificatori
Drawers/filing drawers
Tiroirs/tiroirs pour DS
Cajones/archivadores

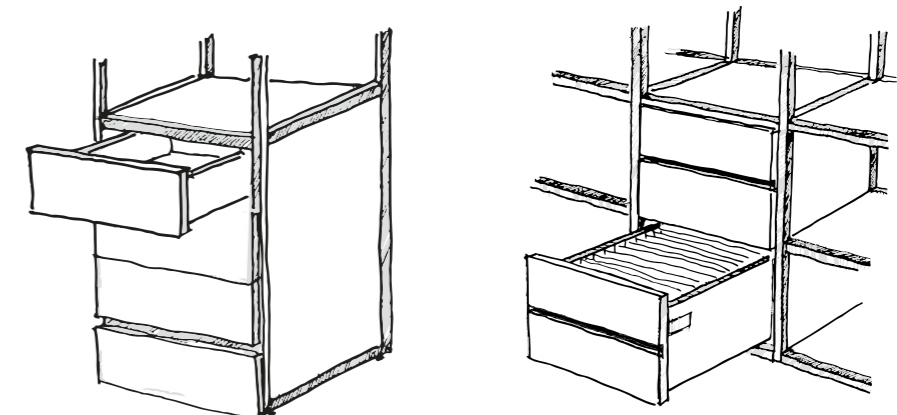

Altezze | Heights | Hauteurs | Alturas

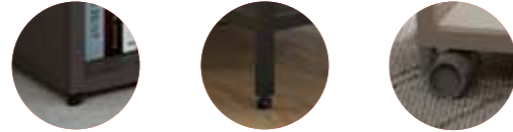

MODULO 352 mm 13 7/8"

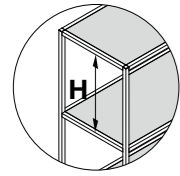

H 334 mm
13 1/8"

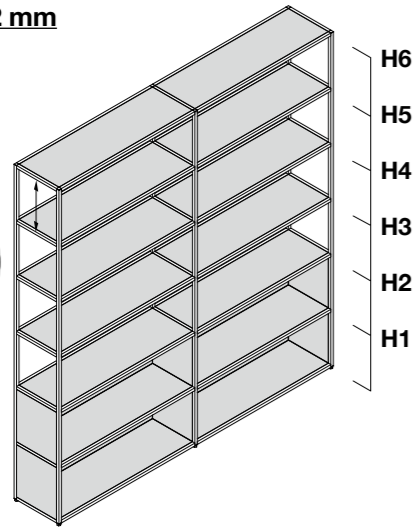

	18 mm 11/16"	82 mm 3 1/4"	44 mm 1 3/4"
H1	388 mm 15 1/4"	452 mm 17 13/16"	414 mm 16 5/16"
H2	740 mm* 29 1/8"	804 mm 31 5/8"	766 mm 30 3/16"
H3	1092 mm 43"	1156 mm 45 1/2"	1118 mm 44"
H4	1444 mm 56 7/8"	1508 mm 59 3/8"	
H5	1796 mm 70 11/16"	1860 mm 73 1/4"	
H6	2148 mm 84 9/16"	2212 mm 87 1/16"	

* Altezze per scrivanie H 740 mm | Heights for desks H 740 mm (29 1/8") | Hauteurs pour bureaux H 740 mm | Alturas para escritorios H 740 mm

MODULO 416 mm 16 3/8"

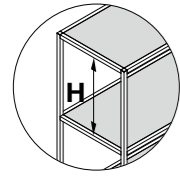

H 398 mm
15 11/16"

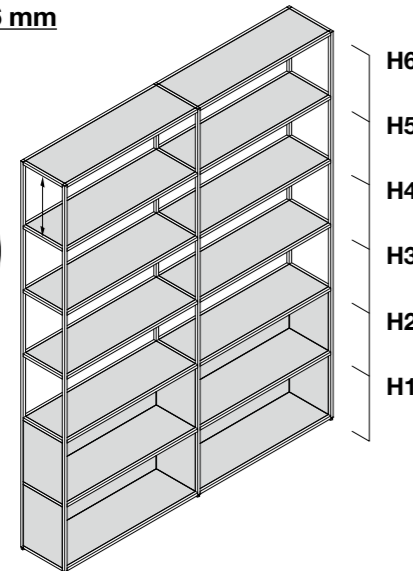

	18 mm 11/16"	82 mm 3 1/4"	44 mm 1 3/4"
H1	452 mm 17 13/16"	516 mm 20 5/16"	478 mm 18 13/16"
H2	868 mm 34 3/16"	932 mm 36 11/16"	894 mm 35 3/16"
H3	1284 mm 50 9/16"	1348 mm 53 1/16"	1310 mm 51 9/16"
H4	1700 mm 66 15/16"	1764 mm 59 3/8"	
H5	2116 mm 83 5/16"	2180 mm 85 13/16"	
H6	2532 mm 99 11/16"	2596 mm 102 3/16"	

Larghezze | Widths | Largeurs | Anchuras

MODULO 300 mm 11 13/16"

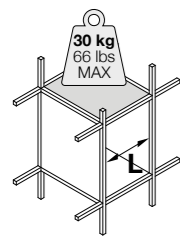

L 282 mm
11 1/8"

MODULO 400 mm 15 3/4"

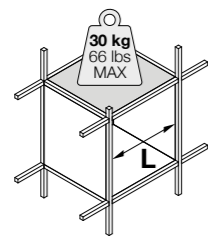

L 382 mm
15 1/16"

MODULO 500 mm 19 11/16"

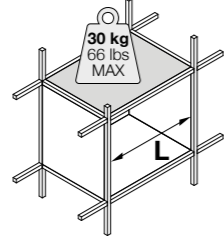

L 482 mm
19"

MODULO 600 mm 23 5/8"

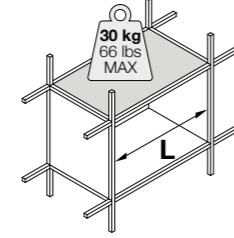

L 582 mm
22 15/16"

MODULO 700 mm 27 9/16"

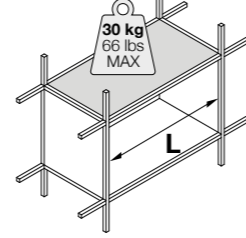

L 682 mm
26 7/8"

30 kg carico massimo per ciascuna mensola | 30 kg (66 lbs) maximum load for each shelf | 30 kg de charge maximale pour chaque étagère | 30 kg de carga máxima por cada estante

MODULO 800 mm 31 1/2"

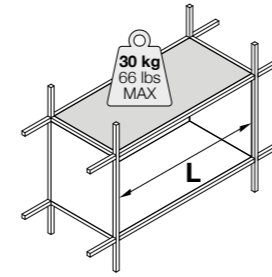

L 782 mm
30 13/16"

MODULO 900 mm 35 7/16"

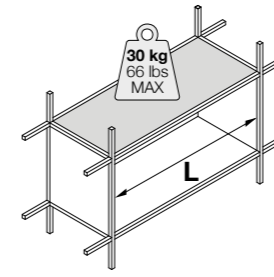

L 882 mm
34 3/4"

MODULO 1000 mm 39 3/8"

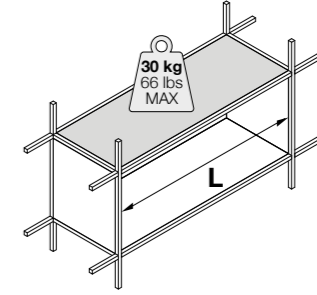

L 982 mm
38 11/16"

Profondità | Depths | Profondeurs | Profundidades

Su piedini | on feet |
sur pieds | con pies

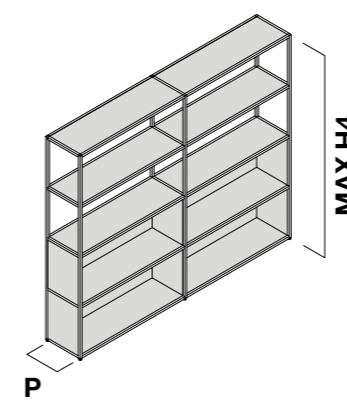

P 330 mm
13"

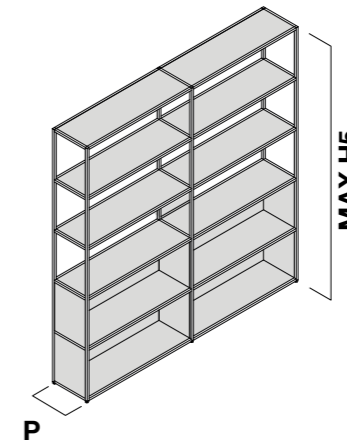

P 394 | 458 mm
15 1/2" | 18"

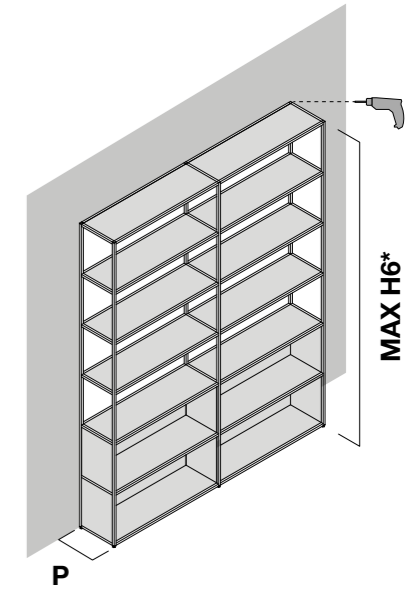

P 330 | 394 | 458 mm
13" | 15 1/2" | 18"

* Altezza massima se fissato al muro | Maximum height when fixed to the wall | Hauteur maximale en cas de fixation au mur | Altura máxima cuando se fija a la pared

Su ruote | on castors |
sur roulettes | con ruedas

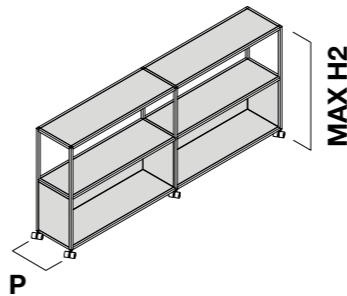

P 330 mm
15 11/16"

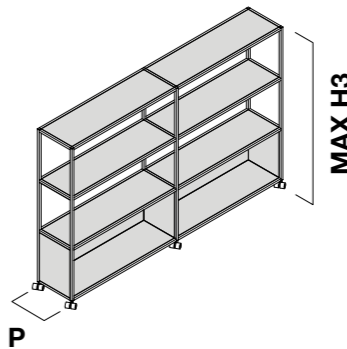

P 394 | 458 mm
15 1/2" | 18"

A soffitto | ceiling-mounted |
au plafond | en el techo

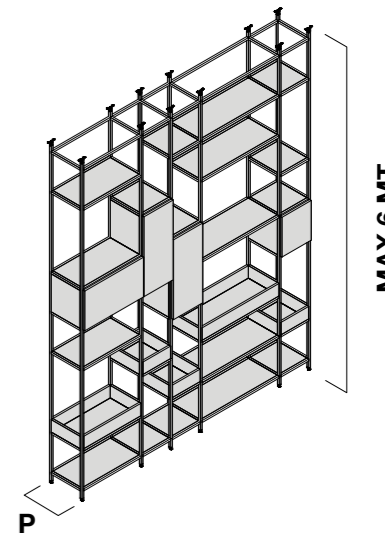

P 330 | 394 | 458 mm
13" | 15 1/2" | 18"

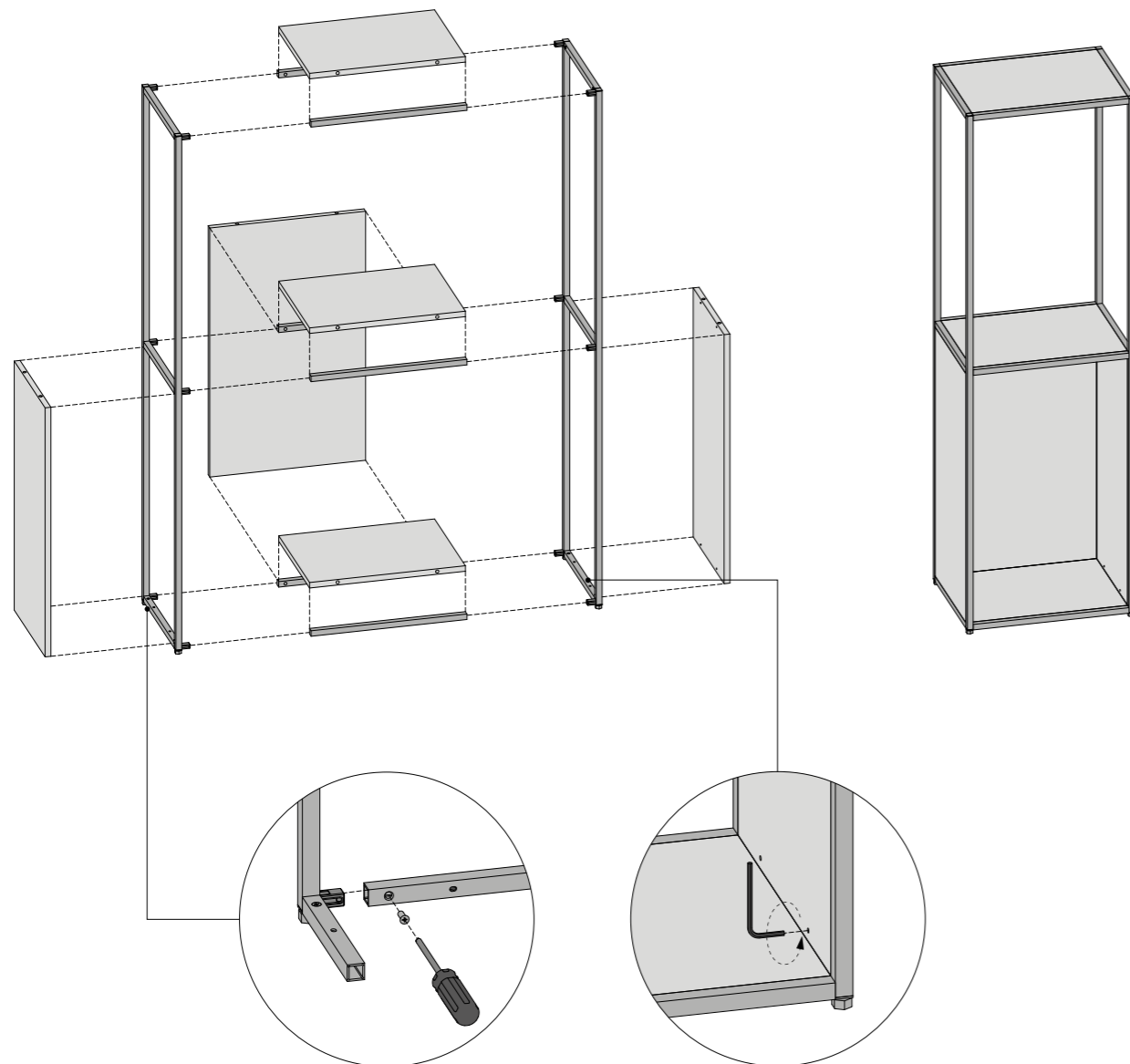
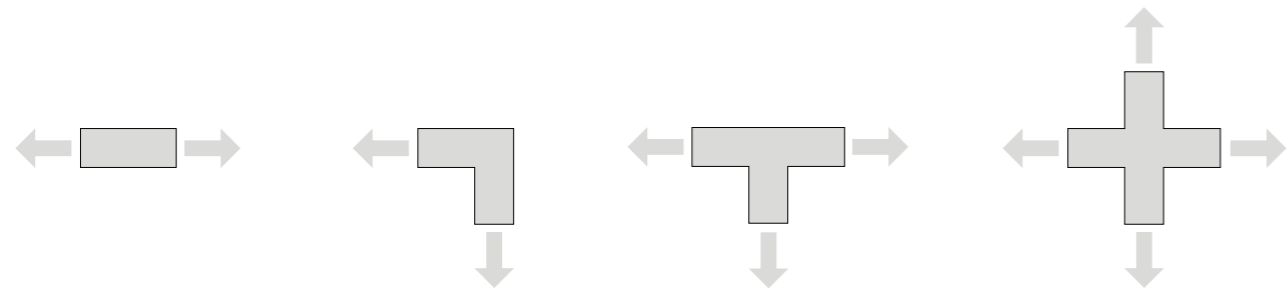

MEL

Melaminico

Melamine | Mèlaminé | Melaminico

Bianco rigato Rippled effect white Blanc avec rayures en sérigraphie Blanco rayado	Grigio rigato Rippled effect grey Gris avec rayures en sérigraphie Gris rayado	Nichel Nickel Nickel Niquel	Cacao Cocoa Cacao Cacao	Bianco White Blanc Blanco
Talco Talco Talco Talco	Ocre Ochre Ocre Ocre	Safari Safari Safari Safari	Noisette Noisette Noisette Noisette	Ardesia Ardesia Ardesia Pizarra
Nero Black Noir Negro	Blu notte Night blue Bleu nuit Azul noche	Rovere chiaro Light oak Chêne clair Roble claro	Rovere americano American oak Chêne américain Roble americano	Rovere grigio Grey oak Chêne gris Roble gris
Rovere moro Dark oak Chêne foncé Roble oscuro	Noce Canaletto Canaletto Walnut Noyer Canaletto Nogal Canaletto	Noce scuro Dark walnut Noyer foncé Nogal oscuro		

MEL

Melaminico scrivibile

Writable melamine | Mèlamine à écrire | Melaminico para escribir

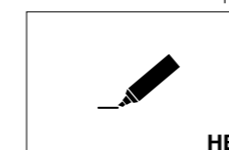

Bianco
White
Blanc
Blanco

Le finiture contenute nella stampa sono puramente indicative e non sono di riferimento per le forniture del prodotto
Due to the printing process, finishes shown in this document are for illustration only. The finish on the final item may differ slightly from the printed illustration
Les finitions contenues dans l'impression sont purement indicatives et ne sont pas pertinentes pour les fournitures du produit
Los acabados contenidos en la impresión son puramente indicativos y no son de referencia para los suministros del producto

EPX

Epossidico

Epoxy | Époxy | Epoxi



Bianco
White
Blanc
Blanco

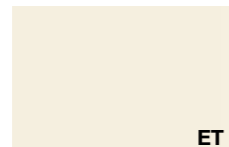

Talco
Talco
Talco
Talco

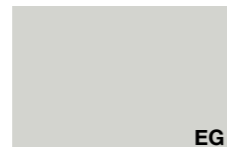

Grigio
Grey
Gris
Gris



Beige Arizona
Arizona beige
Beige Arizona
Beige Arizona



Noisette
Noisette
Noisette
Noisette



Safari
Safari
Safari
Safari



Rame
Copper
Cuivre
Cobre

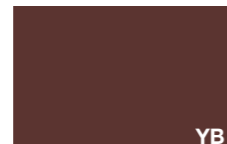

Rosso Jaipur
Jaipur red
Rouge Jaipur
Rojo Jaipur



Bronzo
Bronze
Bronze
Bronze



Blu notte
Night blue
Bleu nuit
Azul noche



Grigio Bromo
Bromo grey
Gris Bromo
Gris Bromo



Ardesia
Ardesia
Ardesia
Pizarra



Verde Comodoro
Comodoro green
Vert Comodoro
Verde Comodoro



Nero
Black
Noir
Negro

Applicazioni finiture

Finish application | Application finitions | Aplicacion acabados



Pannello
Panel
Panneau
Panel



Struttura
Structure
Structure
Structura

Ambiente e sicurezza | Environment and safety | Environnement et sécurité | Medio ambiente y seguridad

Alea utilizza per i suoi prodotti e i suoi imballi materiali facilmente separabili e riciclabili.

Nella produzione dei suoi manufatti, Alea si impegna ad utilizzare materiali legnosi FSC e pannelli a base di legno con certificazione CARB2. I pannelli CARB2 presentano un rilascio di formaldeide inferiore rispetto al pannello E1 comunemente utilizzato (classe E1 secondo il DM 10/10/2008).

Alea uses materials that are easy to separate and recycle for its products and packaging.

Alea is committed to using FSC wood-based materials and CARB2-certified wood-based panels.

CARB2 panels have a lower formaldehyde release than the commonly used E1 panel (class E1 according to DM 10/10/2008).

Alea utilise des matériaux facilement séparables et recyclables pour ses produits et ses emballages.

Dans la production de ses produits, Alea s'engage à utiliser des matériaux en bois FSC et des panneaux à base de bois avec la certification CARB2. Les panneaux CARB2 dégagent moins de formaldéhyde que le panneau E1 couramment utilisé (classe E1 selon DM 10/10/2008).

Para sus productos y embalajes, Alea utiliza materiales fácilmente separables y reciclables.

En la fabricación de sus productos, Alea se compromete a utilizar materiales de madera FSC y paneles de madera con certificación CARB2. Los paneles CARB2 tienen una menor liberación de formaldehído que el panel E1 comúnmente utilizado (clase E1 según DM 10/10/2008).

concept & design

Alea marketing + communication

art director

Mirto Antonel

product design

Mirto Antonel

AF/CACD/AF

Le immagini dei prodotti visibili all'interno di questo catalogo sono inserite a scopo puramente indicativo

The images of the products visible in this catalogue are included for information purposes only
Les images des produits visibles dans ce catalogue sont incluses à titre informatif uniquement
Las imágenes de los productos visibles en este catálogo se incluyen sólo con fines informativos

alea
aleaoffice.com



GLOBAL HEADQUARTERS AND SHOWROOM : Via Col de Rust, 19 - 33070 Sarone (PN) - Italia : Tel ++39 0434 777 333
email: info@aleaoffice.com **PARIS SHOWROOM** : 176 Avenue Charles de Gaulle 92200, Neuilly-sur-Seine - France **NORTH AMERICAN**
HEADQUARTERS : Midtown 2, 3449 NE 1st Avenue L-32, Miami, FL 33137 - USA : Tel ++1 305 470 1200 - email: info@alea-usa.com
ALEA UK OFFICE AND SHOWROOM : 50-54 Clerkenwell Road, London EC1M 5PS - email: info@aleaoffice.com