

alea

meeting-
tables

meeting tables

sale riunioni

Meeting tables
Salles de réunion
Salas de juntas

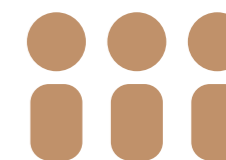

06
Archimede

10
Atreo wood

14
Atreo

18
Blade

22
Blade X

26
Eracle

30
Ibis

32
Italo_forty

36
Oasi

40
Odeon

44
Ortho

48
Rendez Vous

52
Titano

56
Zefiro

58
Zefiro X

62
Atlante

64
Tavoli

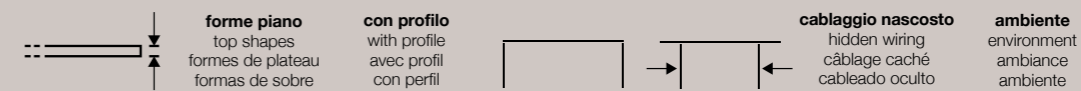

		forme piano top shapes formes de plateau formas de sobre	con profilo with profile avec profil con perfil			cablaggio nascosto hidden wiring câblage caché cableado oculto	ambiente environment ambiance ambiente
1. Archimede	40 mm	■ ■ ● ◻ ◻	x	x	x	x	managerial classic
2. Atreo wood	30 mm	■ ●		x	x		modern
3. Atreo	30 mm	■ ●		x	x		modern
4. Blade	30 mm	■ ■ ●				x	modern
5. Blade X	30 mm	■ ■ ● ◻ ◻				x	managerial classic
6. Eracle	80 mm	■ ■	x	x	x	x	classic
7. Ibis	30 mm	■ ■ ●			x		modern
8. Italo_forty	8 18 mm	■ ■		x			modern
9. Oasi	40 mm	■ ■ ◻	x		x	x	classic
10. Odeon	40 mm	■ ■ ◻	x	x	x	x	classic
11. Ortho	18 30 mm	■ ■		x	x	x	modern
12. Rendez-Vous	18 mm	● ● ◻ ◻			x		modern
13. Titano	60 mm	■ ■ ◻	x	x	x	x	classic
14. Zefiro	12 mm	■ ■		x		x	modern managerial
15. Zefiro X	10 12 mm	■ ■		x		x	managerial
16. Atlante	30 mm	■ ●			x		modern
17. Tavoli con basamento	18 30 40 60 mm	■ ■ ● ◻ ◻	x		x		modern managerial

Archimede



Archimede tables are an elegant solution to furnish meeting rooms. Leg geometries can be different: ring leg, L leg or T leg, also mixed together according to the model. Tops can be framed by an aluminium profile.

Les tables Archimede sont une solution élégante pour meubler les salles de réunion. Les géométries des pieds peuvent être différentes: pied en anneau, pied façonné en L ou pied façonné en T, également mélangés entre eux selon le modèle. Les plateaux peuvent être encadrés par un chant en aluminium.

Las mesas de Archimede son una solución elegante para amueblar las salas de reuniones. Las geometrías de las patas pueden ser diferentes: pata de anillo, pata en L o pata en T, incluso mezcladas según el modelo. Los sobres pueden ser enmarcados por un perfil de aluminio.

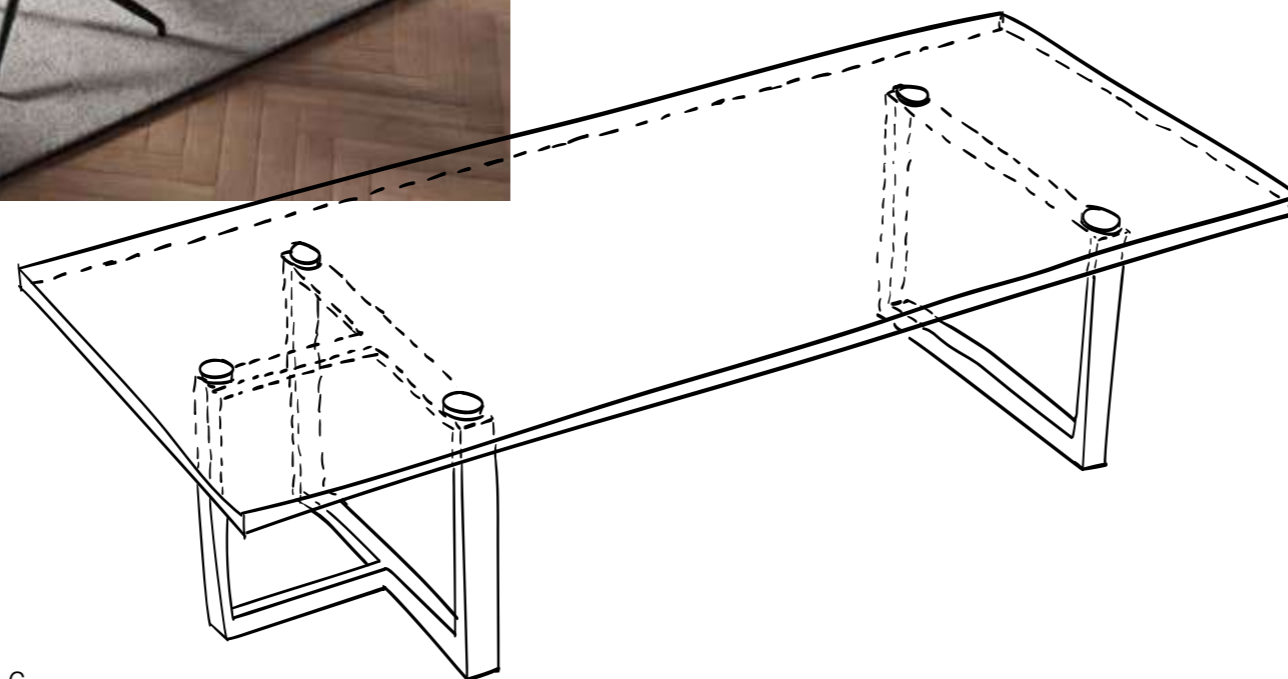

“ I tavoli Archimede sono una soluzione elegante per arredare le sale riunioni. Le geometrie delle gambe possono essere diverse: gamba ad anello, gamba ad L oppure gamba a T, anche mescolate tra loro in base al modello. I piani possono essere incorniciati da un profilo in alluminio. ”





geometric
sleek
architectural



		forme piano top shapes formes de plateau formas de sobre	con profilo with profile avec profil con perfil		cablaggio nascosto hidden wiring câblage caché cableado oculto	ambiente environment ambiance ambiente
Archimede	40 mm		X	X	X	X

Gambe | Legs | Pieds | Patas

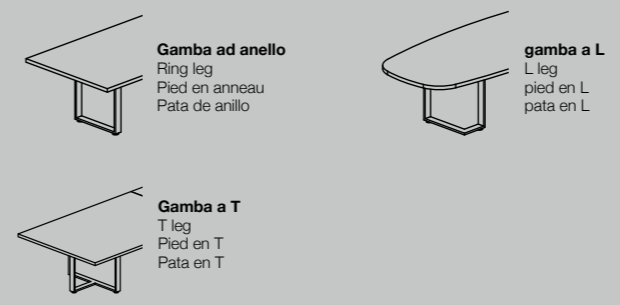

Finiture | Finishes | Finitions | Acabados

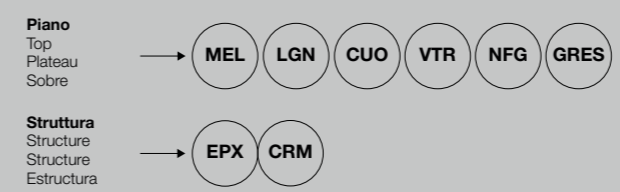

Tavoli riunione | Meeting tables | Tables de réunion | Mesas de juntas

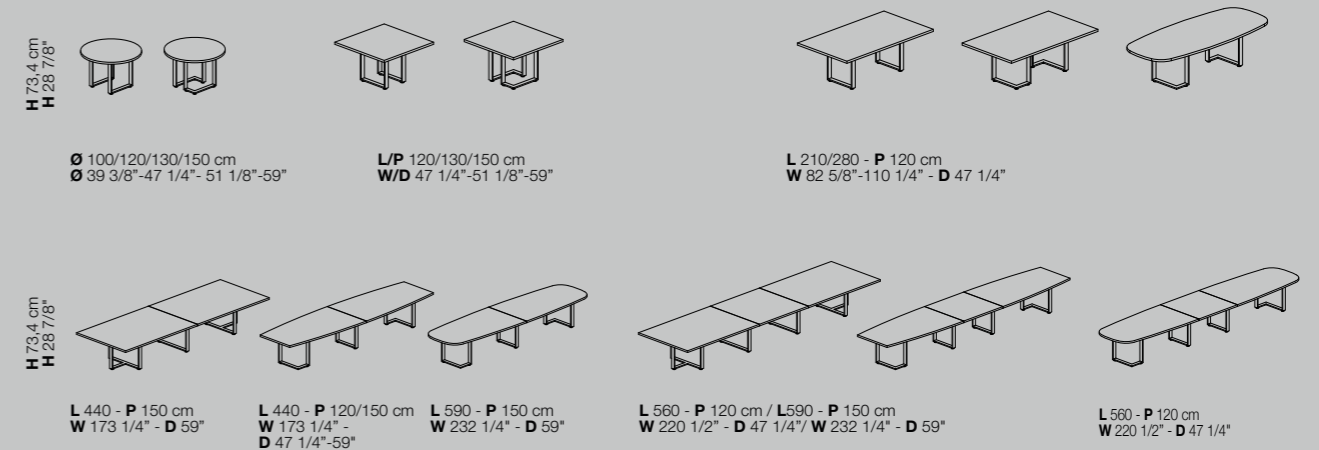

Atreo Wood





“ I tavoli riunione Atreo Wood si contraddistinguono grazie ad un look semplice e fresco. La gamba si caratterizza per l'inserito in legno massello che ne esalta l'aspetto organico. ”

Atreo Wood meeting tables are characterised by a simple and fresh look. The leg features a solid wood insert that enhances its organic feel.

Les tables de réunion Atreo Wood se caractérisent par leur aspect simple et frais. Le piètement est caractérisé par un insert en bois massif qui renforce l'aspect organique.

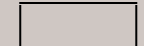
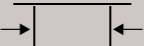

Las mesas de reuniones Atreo Wood destacan por un aspecto sencillo y fresco. La pata se caracteriza por un inserto de madera maciza que realza su aspecto orgánico.

		forme piano top shapes formes de plateau formas de sobre	con profilo with profile avec profil con perfil			cablaggio nascosto hidden wiring câblage caché cableado oculto	ambiente environment ambiance ambiente
Atreo wood	30 mm			X	X		modern

Piani | Desk tops | Plateaux | Sobres



Con angoli dritti
With straight corners
Avec coins droits
Con esquinas rectas



Con angoli raggati
With rounded corners
Avec coins arrondis
Con esquinas redondeadas

Gambe | Legs | Pieds | Patas



A cavalletto
A-shape
Tréteau
Caballete

Finiture | Finishes | Finitions | Acabados

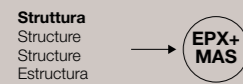

Tavoli riunione | Meeting tables | Tables de réunion | Mesas de juntas

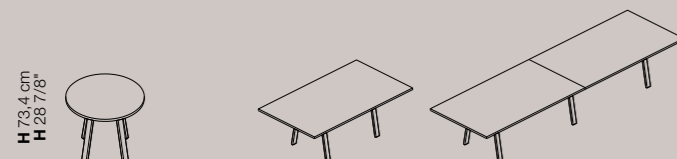

H 73,4 cm
H 28 7/8"

Ø 90/100/120/130/150 cm
Ø 35 3/8/39 3/8/47 1/4/51 1/8/59"

L 210/280 - P 120 cm
W 82 5/8/110 1/4"
D 47 1/4"

L 420/560 - P 120 cm
W 165 3/8/220 1/2"
D 47 1/4"

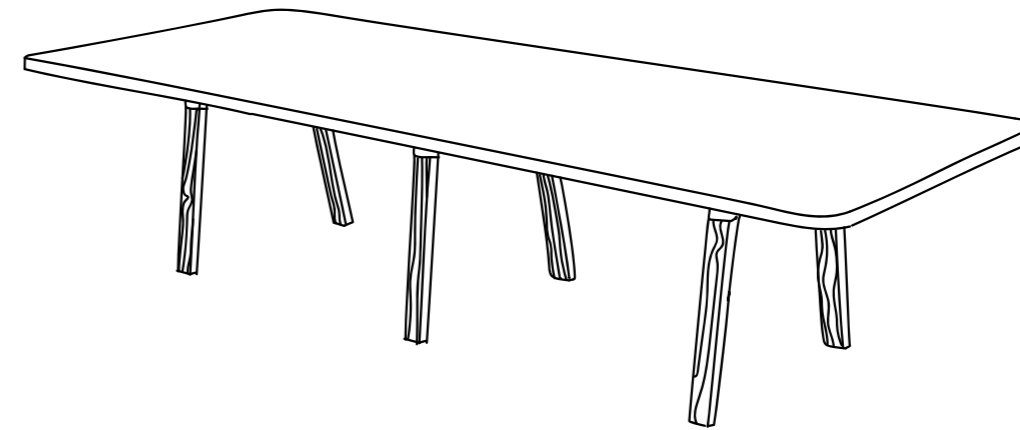

simple
natural
managerial

Atreo

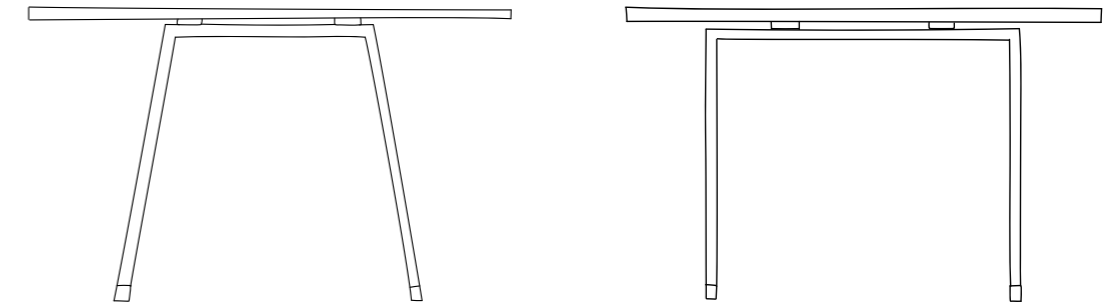
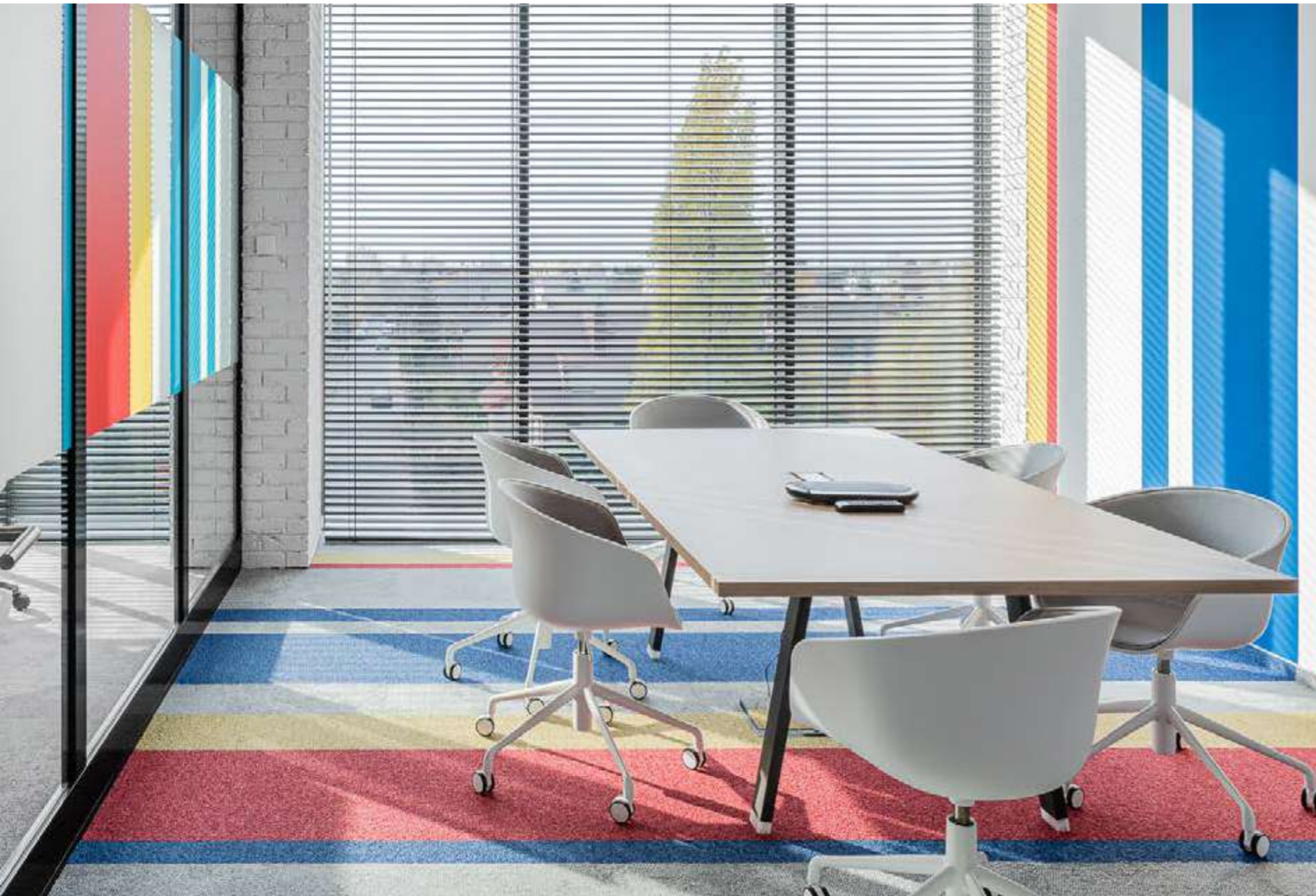

“ I tavoli riunione Atreo possono offrire due possibilità per la scelta della gamba, che può essere a cavalletto o a ponte. ”

Atreo meeting tables offer two options for the choice of leg, which can be A-shaped or straight.

Les tables de réunion Atreo offrent deux options pour le choix du piètement, qui peut être à trapèze ou droit.

Las mesas de reuniones Atreo ofrecen dos opciones para la elección de la pata, que puede ser de caballete o recta.



Atreo	30 mm	■●		X	X		modern
-------	-------	----	--	---	---	--	--------

Piani | Desk tops | Plateaux | Sobres

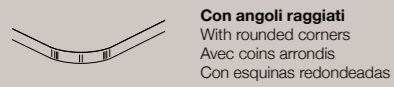
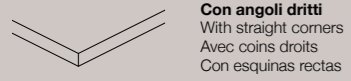

Gambe | Legs | Pieds | Patas

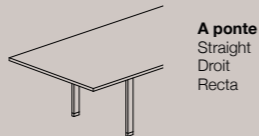

Finiture | Finishes | Finitions | Acabados

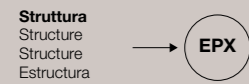

Tavoli riunione | Meeting tables | Tables de réunion | Mesas de juntas

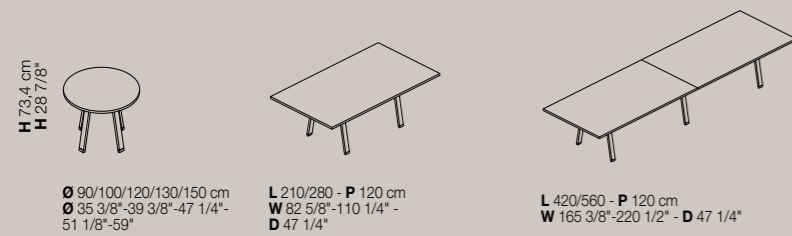

modern
linear
simple



Blade



“ I tavoli Blade hanno un design fluido, caratterizzato dalla gamba a forma di lama, essenziale ed unica. I piani presentano una raggiatura sugli angoli per armonizzarsi completamente con la struttura. ”



Blade tables have a fluid design, characterized by the blade shaped leg, essential and unique. Tops have a radius on the corners to harmonize completely with the structure

Les tables Blade ont un design fluide, caractérisé par le pied en forme de lame, essentiel et unique. Les plateaux ont les coins arrondis afin de s'harmoniser complètement avec la structure.

Las mesas Blade tienen un diseño fluido, caracterizado por la pata en forma de hoja, esencial y único. Los sobres tienen un radiado en las esquinas para armonizar con la estructura.



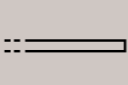
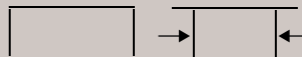

	 forme piano top shapes formes de plateau formas de sobre	con profilo with profile avec profil con perfil	 cablaggio nascosto hidden wiring câblage caché cableado oculto	ambiente environment ambiance ambiente	
Blade	30 mm			X	modern

Piani | Desk tops | Plateaux | Sobres

Con angoli raggati
 With rounded corners
 Avec coins arrondis
 Con esquinas redondeadas

Gambe | Legs | Pieds | Patas

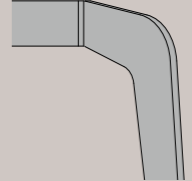



Spessore 1,2 cm
 1,2 cm thick (1/2")
 1,2 cm d'épaisseur
 1,2 cm de espesor

Finiture | Finishes | Finitions | Acabados

Piano
 Top
 Plateau
 Sobre → **MEL**

Struttura
 Structure
 Structure
 Estructura → **EPX**

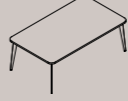
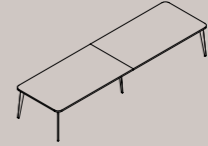
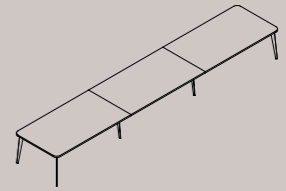
Tavoli riunione | Meeting tables | Tables de réunion | Mesas de juntas

				
H 73,4 cm H 28 7/8"	Ø 120/150 cm Ø 47 1/4"-59"	L/P 120/160 cm W/D 47 1/4"-63"	L 210/280 - P 120 cm W 82 5/8"-110 1/4" - D 47 1/4"	L 420/560 - P 120 cm W 165 3/8"-220 1/2" - D 47 1/4"
			L 630 - P 120 cm W 248" - D 47 1/4"	



managerial
geometric
classic

Blade X



“ I tavoli Blade X hanno un design fluido, caratterizzato dalla gamba a forma di lama, essenziale ed unica. Il metallo può essere impreziosito da un rivestimento in legno massello oppure in cuoio, materiali che possono essere utilizzati anche sui piani. ”

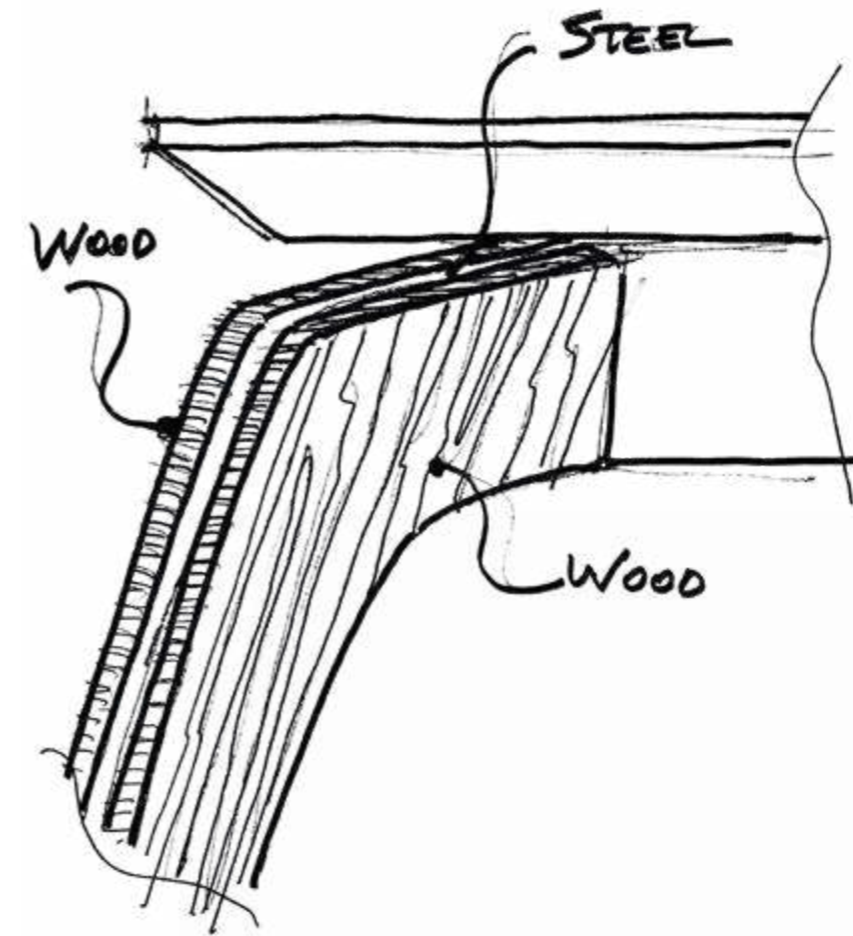

The Blade X tables have a fluid design, characterized by the blade-shaped leg, essential and unique. Metal can be embellished with solid wood or leather covers, materials that can also be used on worktops.

Les tables Blade X ont un design fluide, caractérisé par le pied en forme de lame, essentiel et unique. Le métal peut être embelli par des décorations en bois massif ou en cuir, matériaux qui peuvent également être utilisés sur les plateaux.

Las mesas Blade X tienen un diseño fluido, caracterizado por la pata en forma de hoja, esencial y único. El metal puede ser adornado con un recubrimiento en madera maciza o tapicería de cuero, materiales que también pueden ser utilizados en los sobres.





managerial geometric classic

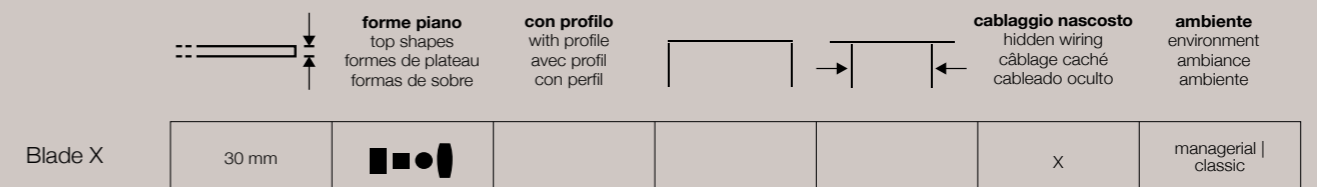

Gambe | Legs | Pieds | Patas

Spessore 1,2 cm | 1,2 cm (1/2") thick | 1,2 cm d'épaisseur | 1,2 cm de espesor

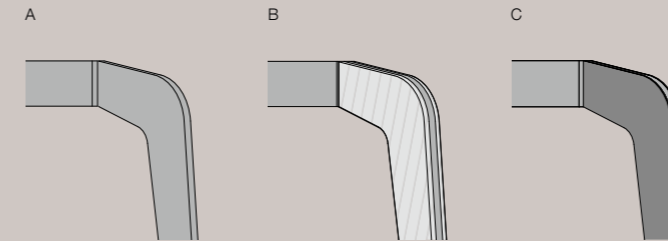

A) Metallo verniciato epossidico B) Con rivestimento in legno C) Con rivestimento in cuoio
 A) Metal epoxy painted B) With wood veneer cover C) With leather cover
 A) Métal peint époxy B) Avec revêtement en bois C) Avec revêtement en cuir
 A) Metal pintado epoxi B) Con recubrimiento de madera C) Con recubrimiento de cuero

Piani | Desk tops | Plateaux | Sobres

Spessore 3 cm | 3 cm (1 1/8") thick | 3 cm d'épaisseur | 3 cm de espesor

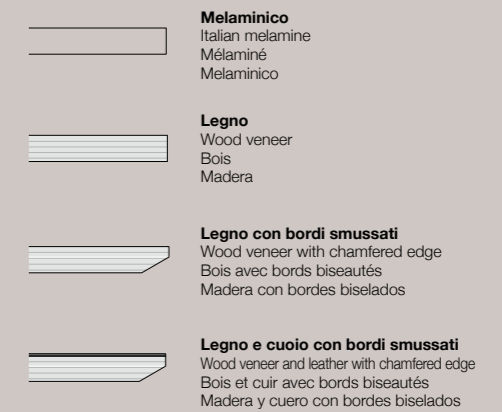

Finiture | Finishes | Finitions | Acabados

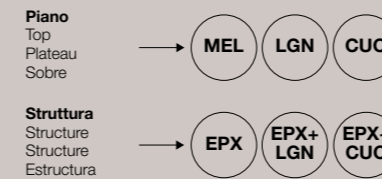

Tavoli riunione | Meeting tables | Tables de réunion | Mesas de juntas

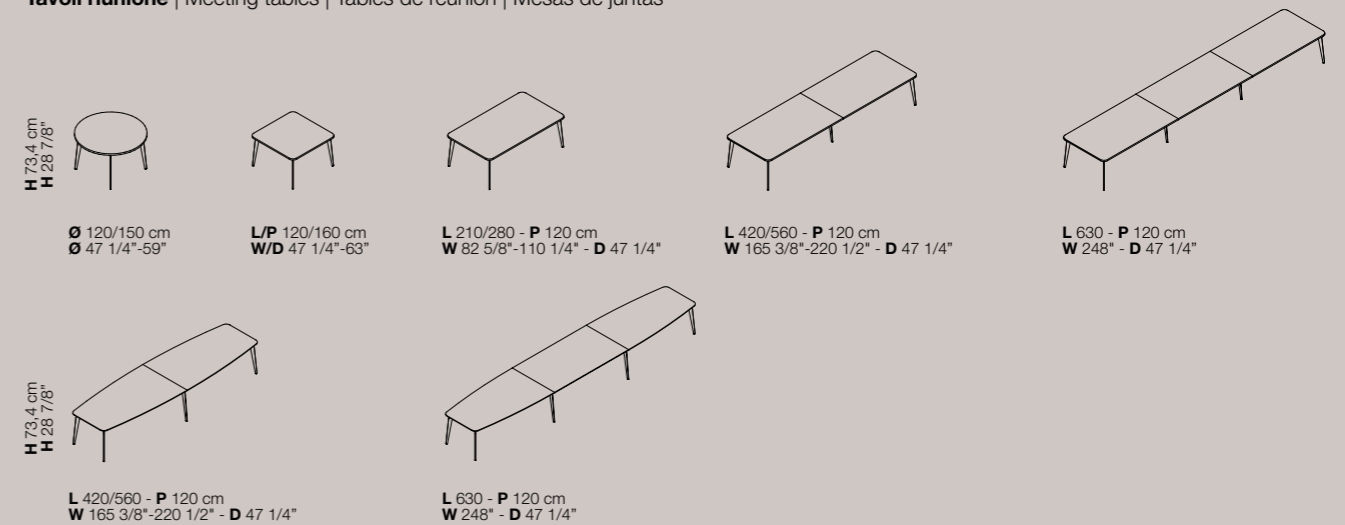

Eracle

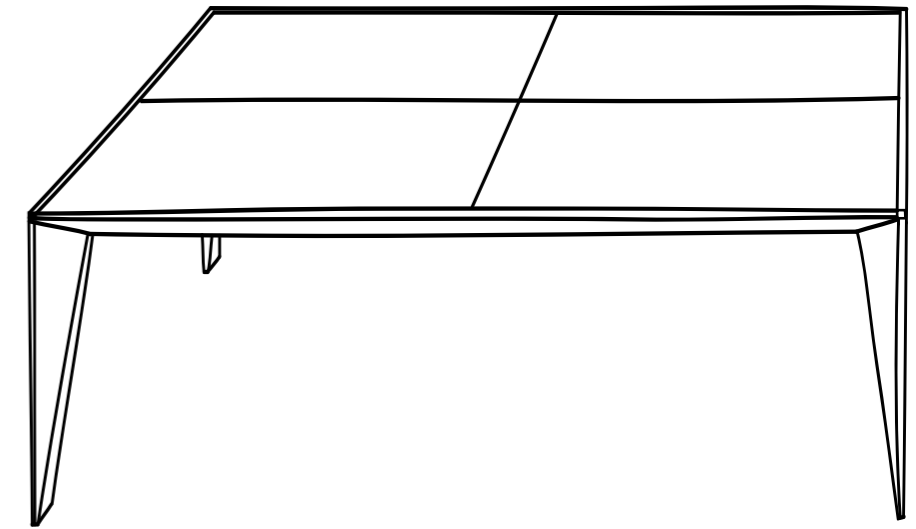

“ Eracle è una collezione che è caratterizzata dalla forte presenza dell'alluminio nella sua struttura. Questo materiale valorizza la particolare forma a diamante delle gambe innalzando il prodotto ad un design non convenzionale. ”

Eracle is a collection that is characterised by the strong presence of aluminium in its structure. This material enhances the distinctive diamond shape of the legs, elevating the product to an unconventional design.

Eracle est une collection qui se caractérise par la forte présence de l'aluminium dans sa structure. Ce matériau met en valeur la forme distinctive en diamant des pieds, élevant le produit à un niveau de design non conventionnel.

Eracle es una colección que se caracteriza por la fuerte presencia del aluminio en su estructura. Este material realza la peculiar forma de diamante de las patas, elevando el producto a un diseño poco convencional.

classic
institutional
characteristic



	forme piano top shapes formes de plateau formas de sobre	con profilo with profile avec profil con perfil			cablaggio nascosto hidden wiring câblage caché cableado oculto	ambiente environment ambiance ambiente
Eracle	80 mm		X	X	X	classic

Gambe | Legs | Pieds | Patas



Gambe angolari - alluminio/cuoio
 Corner legs - aluminium/leather
 Piètements d'angle - aluminium/ cuir
 Patas angulares - aluminio/cuero

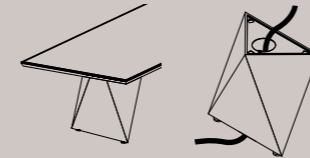

Basamento a diamante - alluminio
 Diamond-shaped base - aluminium
 Base à diamant - aluminium
 Base en forma de diamante - aluminio

Finiture | Finishes | Finitions | Acabados

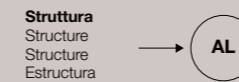
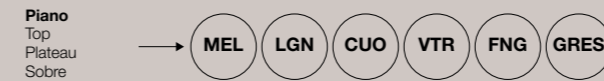

Tavoli riunione | Meeting tables | Tables de réunion | Mesas de juntas

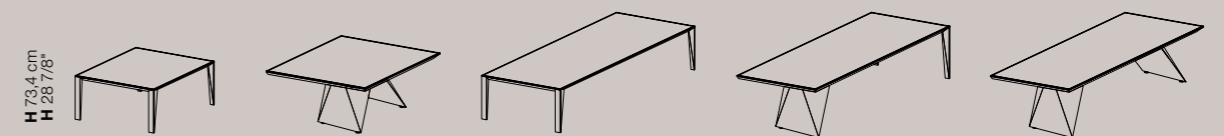

H 73,4 cm
 H 28 7/8"

L/P 120/150/200 cm
 W/D 47 1/4"-59"-78 3/4"

L/P 150 cm
 W/D 59"

L 240/300 - P 120 cm
 W 94 1/2"-118 1/8" D 47 1/4"

Ibis



“ I tavoli riunione della collezione Ibis sono caratterizzati dal basamento incrociato in tubolare dalla sezione quadrata. ”



The meeting tables of the Ibis collection are characterised by a crossed tubular base with a square section.

Les tables de réunion de la collection Ibis se caractérisent par un piètement tubulaire croisé de section carrée.

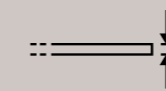
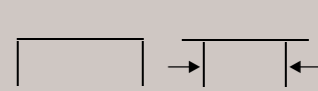
Las mesas de reunión de la colección Ibis se caracterizan por una base tubular cruzada de sección cuadrada.

		forme piano top shapes formes de plateau formas de sobre	con profilo with profile avec profil con perfil		cablaggio nascosto hidden wiring câblage caché cableado oculto	ambiente environment ambiance ambiente
Ibis	30 mm			X		modern

Gambe | Legs | Pieds | Patas

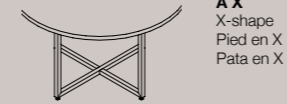

Finiture | Finishes | Finitions | Acabados

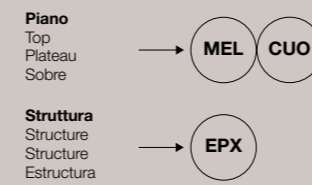

Tavoli riunione | Meeting tables | Tables de réunion | Mesas de juntas

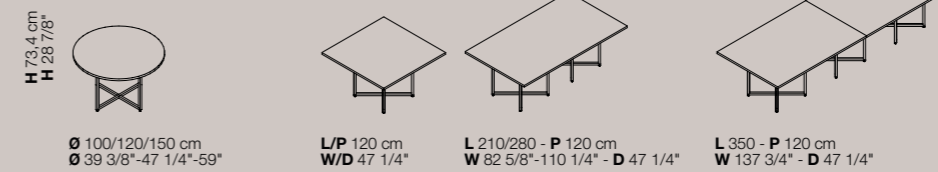

Italo_forty



“ I tavoli Italo_forty sono caratterizzati dall'innovativo sistema di fissaggio dei piani alla struttura metallica, solida e performante. Italo_forty consente di realizzare tavoli riunione fino a 300 cm di lunghezza senza ricorrere all'utilizzo di supporti intermedi. ”



Italo_forty tables are characterized by the innovative fixing system of the tops to the metal structure, solid and performing. Italo_forty allows the creation of meeting tables up to 300 cm long without using intermediate supports.

Les tables Italo_forty se caractérisent par le système innovant de fixation des plateaux à la structure métallique, solide et performante. Italo_forty permet de réaliser des tables de réunion jusqu'à 300 cm de longueur sans utiliser de supports intermédiaires.

Las mesas Italo_forty se caracterizan por el innovador sistema de fijación de los tableros a la estructura metálica, sólido y eficaz. Italo_forty permite realizar mesas de reunión de hasta 300 cm de largo sin utilizar soportes intermedios.

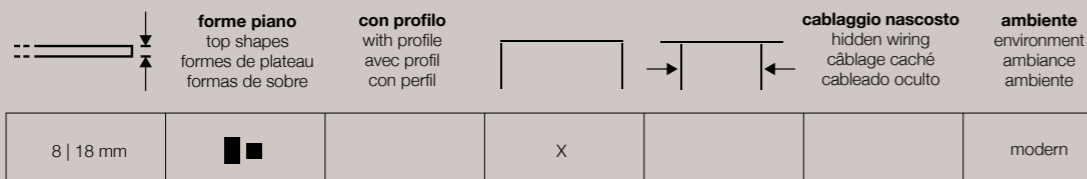

Gambe | Legs | Pieds | Patas

Sezione 4x4 cm | Section 4x4 cm (1 5/8"x 1 5/8") | Section 4x4 cm | Sección 4x4 cm

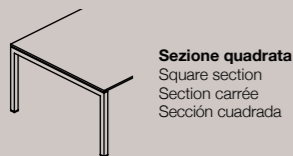

Finiture | Finishes | Finitions | Acabados

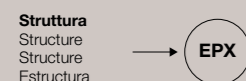

Tavoli riunione | Meeting tables | Tables de réunion | Mesas de juntas

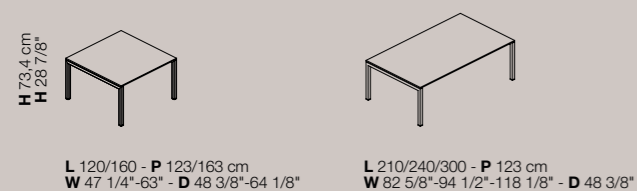

modern
functional
easy

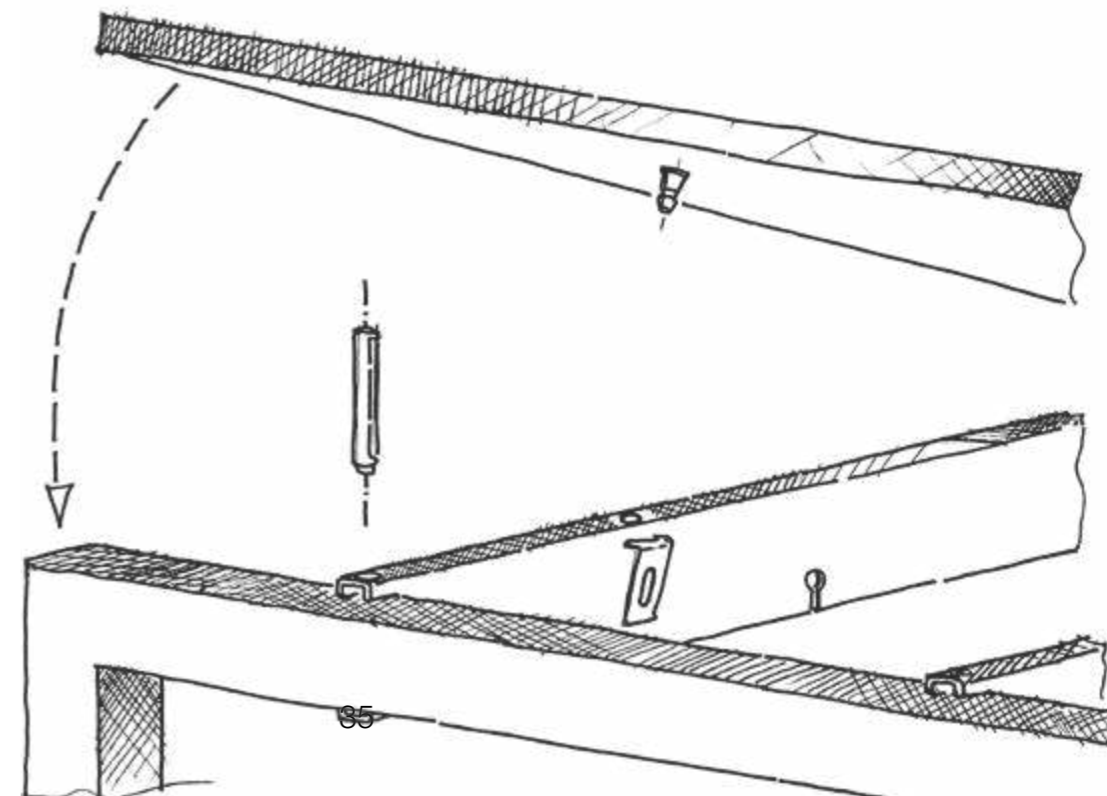

Oasi



“ Il tavolo riunione Oasi è espressione di solidità ed eleganza. Due lame di metallo sostengono il piano che si spinge fino ad una lunghezza di 630 cm, disponibile in essenza legno. ”

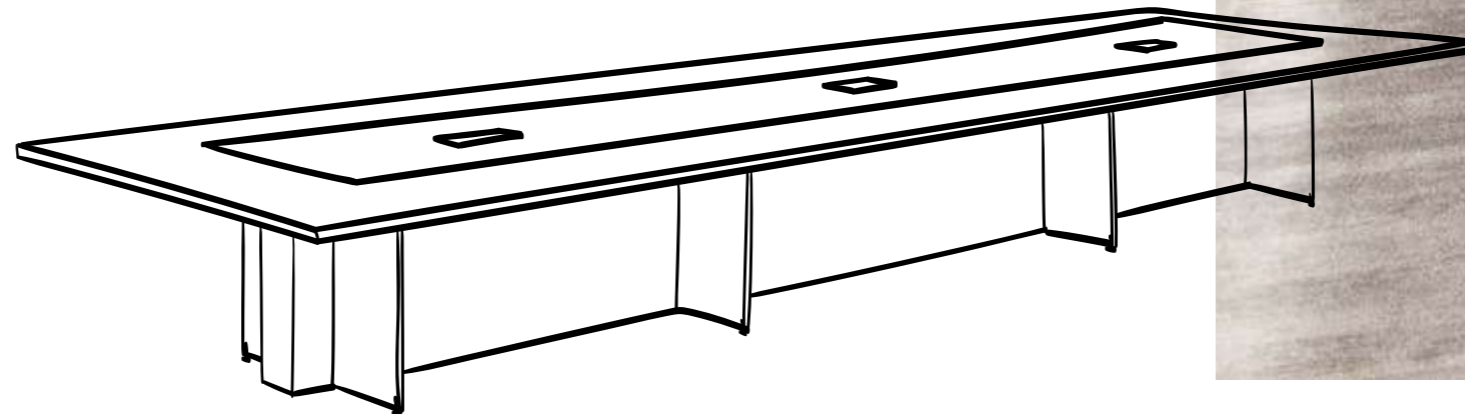

The Oasi meeting table is an expression of solidity and elegance. Two metal blades support the top that extends to a length of 630 cm, available in wood essence and melamine.

La table de réunion Oasi est l'expression de la grandeur et de l'élégance. Deux lames métalliques soutiennent le plateau qui s'étend sur une longueur de 630 cm, disponible en essence de bois et en mélaminé.

La mesa de reuniones Oasi es una expresión de solidez y elegancia. Dos láminas metálicas soportan el tablero que se extiende hasta una longitud de 630 cm, disponible en madera y melamina





classic
strong
impressive



Oasi	40 mm		X		X	X	classic
------	-------	--	---	--	---	---	---------

Struttura | Structure | Structure | Estructura

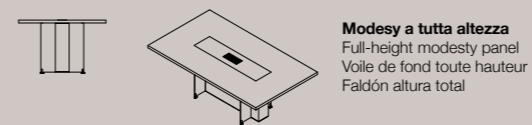

Finiture | Finishes | Finitions | Acabados



Tavoli riunione | meeting tables | tables de réunion | mesas de juntas

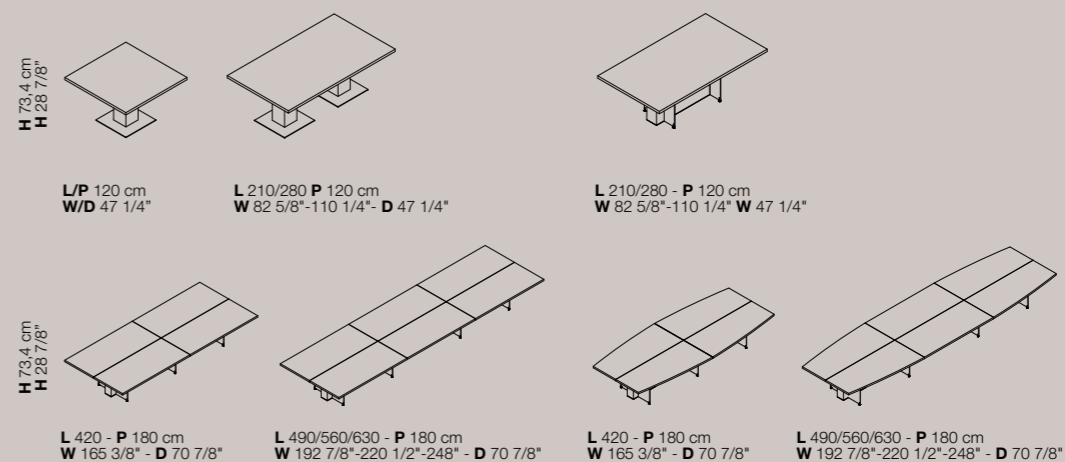

Odeon



“ Odeon è una collezione classica che arriva a coprire dimensioni ampie per sale riunioni e conferenze. ”



Odeon is a classic collection that covers large dimensions for meeting and conference rooms.

Odeon est une collection classique qui couvre de grandes dimensions pour les salles de réunion et de conférence.

Odeon es una colección clásica que abarca grandes dimensiones para salas de reuniones y conferencias.



		forme piano top shapes formes de plateau formas de sobre	con profilo with profile avec profil con perfil		cablaggio nascosto hidden wiring câblage caché cableado oculto	ambiente environment ambiance ambiente
Odeon	40 mm		X	X	X	classic

Gambe | Legs | Pieds | Patas

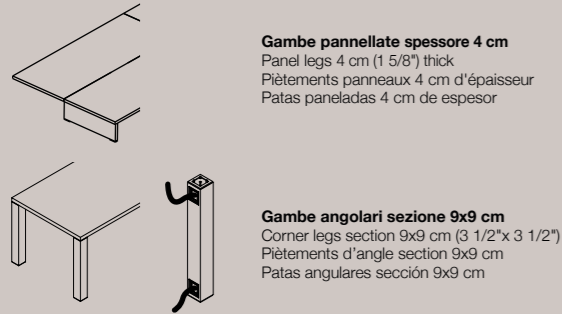

Finiture | Finishes | Finitions | Acabados

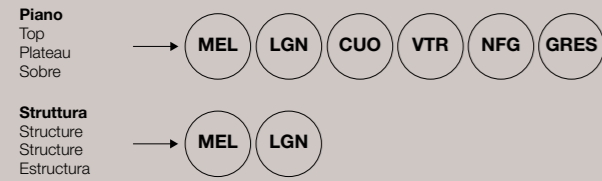

Tavoli riunione | Meeting tables | Tables de réunion | Mesas de juntas

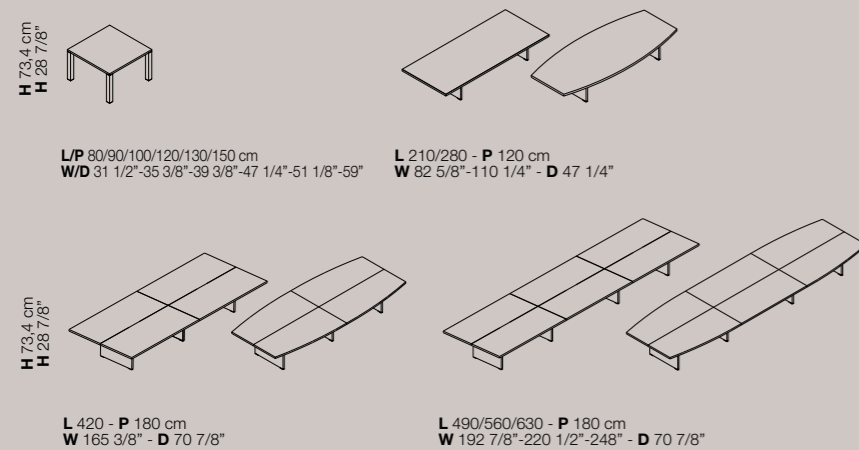

classic
wood
architectural



Ortho



“ Ortho presenta tavoli riunione semplici e funzionali. La struttura in metallo permette il passaggio dei cavi dal piano sino a terra rendendo l'ambiente ordinato. ”

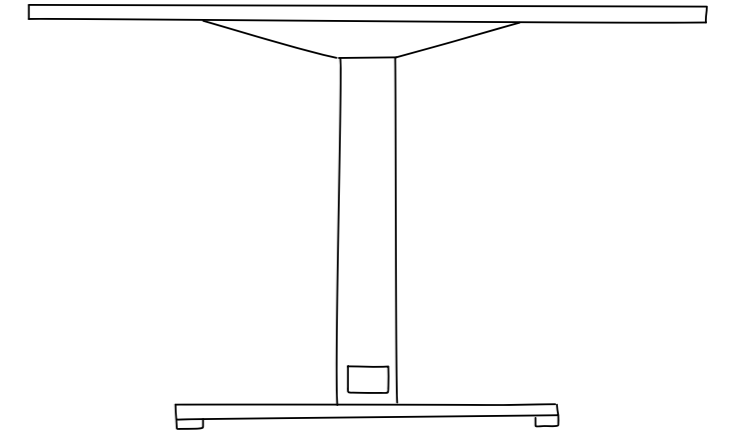

Ortho presents simple and functional meeting tables. The metal structure allows cable transit from the top to the ground, making the environment tidy.

Ortho présente des tables de réunion extrêmement simples et fonctionnelles. En effet, la structure métallique permet le passage des câbles. En rendant l'environnement propre.

Ortho presenta mesas de reuniones extremadamente simples y funcionales. De hecho, la estructura metálica permite el paso de los cables desde el sobre hasta el suelo, haciendo que el ambiente sea ordenado.

modern
technical
pragmatic



Ortho	18 30 mm			X	X	X	modern
-------	------------	--	--	---	---	---	--------

Struttura | Structures | Structures | Estructuras



Struttura in metallo elettrificata, regolabile in altezza manualmente
 Electrified metal structure, manually height-adjustable
 Structure en métal électrifiée, réglable manuellement en hauteur
 Estructura metálica electrificada, regulable manualmente en altura

Finiture | Finishes | Finitions | Acabados

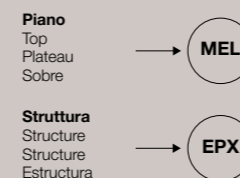

Tavoli riunione | Meeting tables | Tables de réunion | Mesas de juntas



Rendez-Vous

“ Rendez-Vous si distingue per il suo tratto sottile e slanciato. La struttura è in tubolare metallico (35 mm di diametro) e si raccorda al piano che è disponibile in diverse forme: rettangolare, rotondo, quadrato, a forma di 8 e ovale. ”



Rendez-Vous is distinguished by its slim and sleek design. The frame is made of tubular metal (35 mm in diameter) and is connected to the top, which is available in different shapes: rectangular, round, square, 8-shaped and oval.

Rendez-Vous se distingue par son design fin et élancé. Le cadre est en métal tubulaire (35 mm de diamètre) et est relié au plateau, qui est disponible en différentes formes: rectangulaire, rond, carré, en forme de 8 et ovale.

Rendez-Vous se destaca por su diseño fino y estilizado. La estructura es de metal tubular (35 mm de diámetro) y se fija al sobre, que está, disponible en distintas formas: rectangular, redonda, cuadrada, en forma de 8 y ovalada.

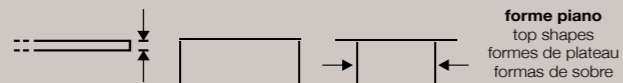

forme piano
top shapes
formes de plateau
formas de sobre

ambiente
environment
ambiance
ambiente

cablaggio nascosto
hidden wiring
câblage caché
cableado oculto

con profilo
with profile
avec profil
con perfil

Rendez-Vous

18 mm			■ ■ ● ● ● ●	modern		
-------	--	--	-------------	--------	--	--

Finiture | Finishes | Finitions | Acabados

Piano
Top
Plateau
Sobre
→ MEL LGN FNX

Struttura
Structure
Structure
Estructura
→ EPX

Tavoli riunione | Meeting tables | Tables de réunion | Mesas de juntas

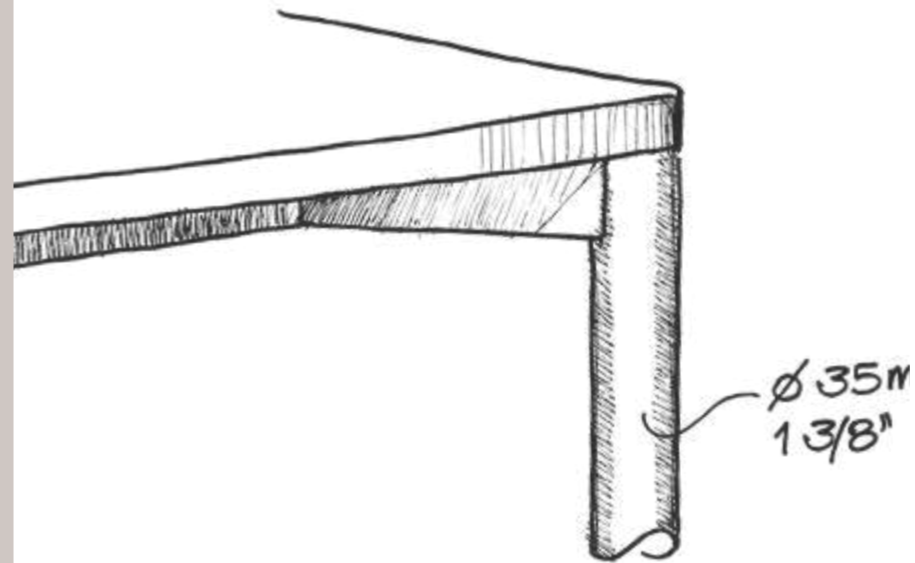
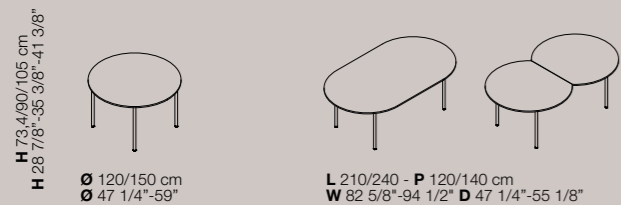

modern
flexible
stylish



Titano

“ Titano presenta una serie di tavoli di forma rettangolare e sagomata, con piano unico oppure modulari. Questi ultimi possono arrivare ad una lunghezza di 840 cm. ”



Titano presents a series of rectangular and shaped tables, with single or modular tops. The latter can reach a length of 840 cm.

Titano présente une série de tables rectangulaires et en forme tonneau, réalisées grâce à plateaux d'un seul tenant ou modulaires. Ce dernier peut atteindre une longueur de 840 cm.

Titano presenta una serie de mesas rectangulares y moldeadas, con sobre único o modulares. Este último puede alcanzar una longitud de 840 cm.



		forme piano top shapes formes de plateau formas de sobre	con profilo with profile avec profil con perfil		cablaggio nascosto hidden wiring câblage caché cableado oculto	ambiente environment ambiance ambiente
Titano	60 mm		X	X	X	classic

Gambe | Legs | Pieds | Patas
Spessore 7,7 cm | 7,7 cm (3") thick | 7,7 cm d'épaisseur | 7,7 cm de espesor

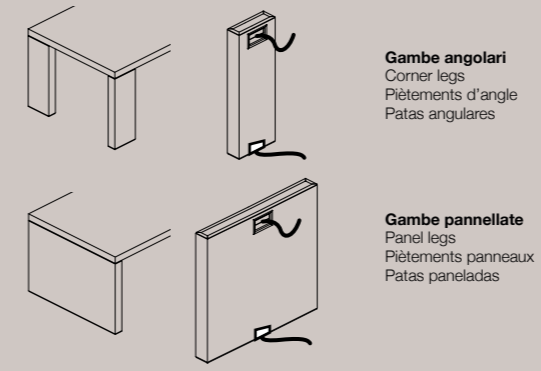

Finiture | Finishes | Finitions | Acabados

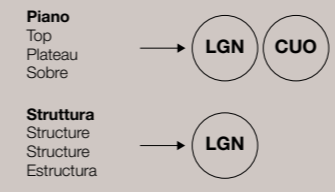

Tavoli riunione | Meeting tables | Tables de réunion | Mesas de juntas

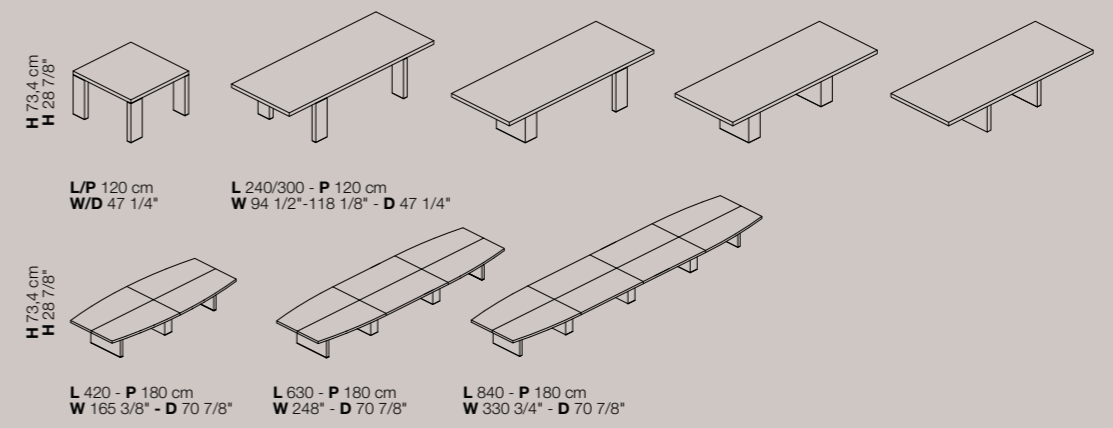

classic
strong
wood

Zefiro

— durable —
— ever green —
— classic —





Zefiro has a light structure made of aluminium, resistant and easily adaptable to different sizes.

“ Zefiro presenta una struttura in alluminio leggera, resistente e facilmente adattabile a diverse dimensioni. ”

Zefiro se caractérise par une structure en aluminium légère, solide et facilement adaptable à différentes tailles.

Zefiro presenta una estructura de aluminio ligera, resistente y fácilmente adaptable a diferentes tamaños.

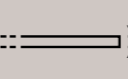
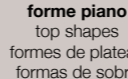
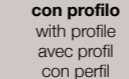

		forme piano top shapes formes de plateau formas de sobre		con profilo with profile avec profil con perfil		cablaggio nascosto hidden wiring câblage caché cableado oculto	ambiente environment ambiance ambiente
Zefiro	12 mm			X		X	modern managerial

Gambe | Legs | Pieds | Patas

Sezione 5,4x5,4 cm | Section 5,4x5,4 cm (2 1/8"x2 1/8") thick | Section 5,4x5,4 cm | Sección 5,4x5,4 cm

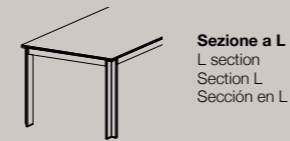

Sezione a L
L section
Section L
Sección en L



Sezione a L con inserto in melaminico o legno
L section with Italian melamine or wood insert
Section L avec insert en mélaminé ou bois
Sección en L con inserto de melaminico o madera



Sezione quadrata
Square section
Section carrée
Sección cuadrada

Finiture | Finishes | Finitions | Acabados

Piano
Top
Plateau
Sobre

→ MEL LGN VTR NFG

Struttura
Structure
Structure
Estructura

→ AL AL+ LGN BR BR+ LGN EPX

Tavoli riunione | Meeting tables | Tables de réunion | Mesas de juntas

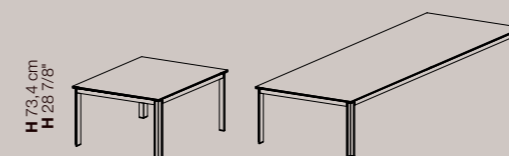

H 73,4 cm
H 28 7/8"

L/P 90/110 cm W/D 35 3/8"-43 1/4" L 230/270 - P 110 cm W 90 1/2"-106 1/4" - D 43 1/4"

Zefiro X



“ Zefiro X è un redesign in chiave moderna della collezione Zefiro, nei tavoli riunione i piani si allungano e nelle dimensioni più grandi vengono sostenuti da un supporto in metacrilato trasparente. ”



Zefiro X is a modern redesign of the Zefiro collection. In the meeting tables, tops are extended and in the larger sizes are supported by a transparent acrylic stand.

Zefiro X est une moderne design de la collection Zefiro. dans les tables de réunion, les plateaux s'allongent et dans les grandes tailles, ils sont soutenus par un support en méthacrylate transparent.

Zefiro X es un rediseño en clave modernade la colección Zefiro; en las mesas de reuniones los tableros se hacen más largos y en los tamaños más grandes se apoyan en una base de metacrilato transparente.

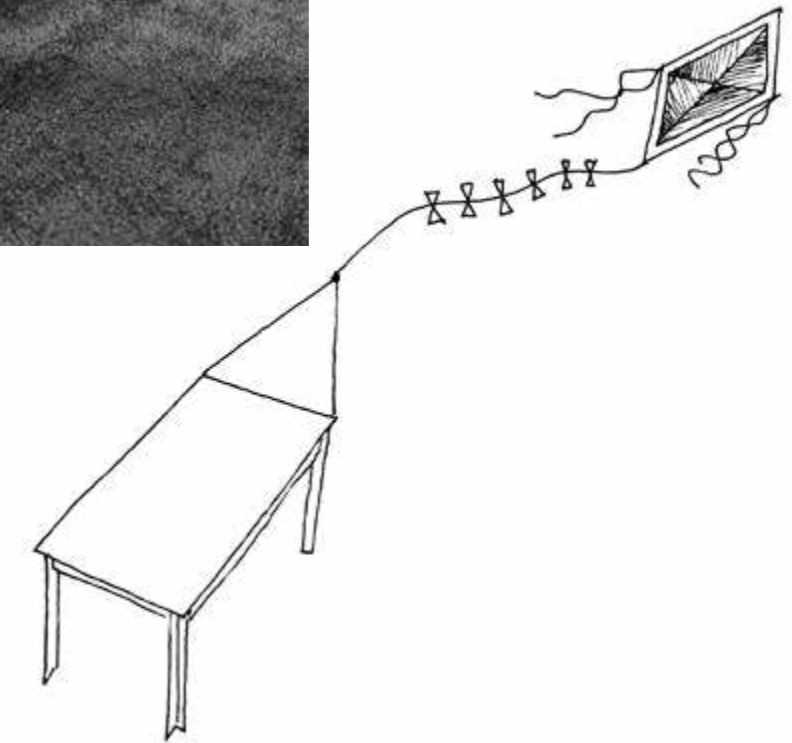



Zefiro X	10 12 mm		X	X	managerial
----------	------------	--	---	---	------------

Gambe | Legs | Pieds | Patas

Sezione 5,4x5,4 cm | Section 5,4x5,4 cm (2 1/8"x2 1/8") thick | Section 5,4x5,4 cm | Sección 5,4x5,4 cm

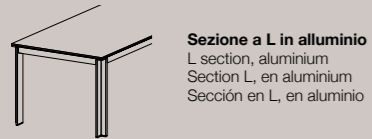

Finiture | Finishes | Finitions | Acabados



Basamenti per tavoli multipli L 400 cm | Support for multiple tables W 400 cm (157 1/2") | Bases pour tables multiples L 400 cm | Bases para mesas múltiples L 400 cm

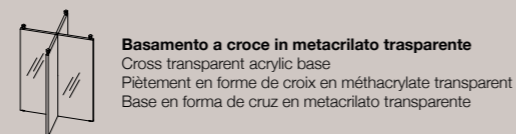

Tavoli riunione | Meeting tables | Tables de réunion | Mesas de juntas

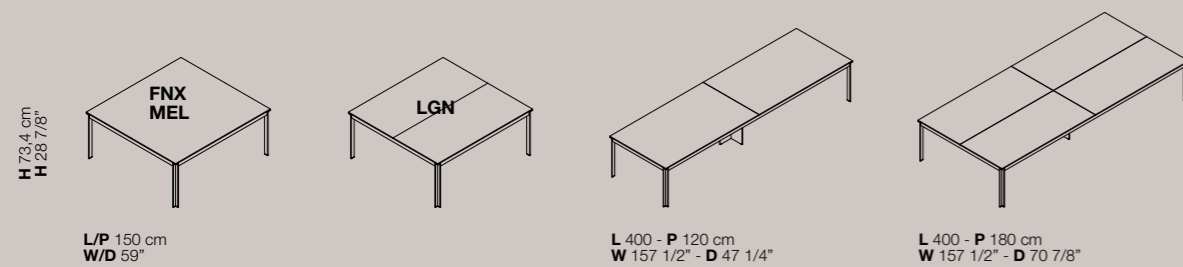
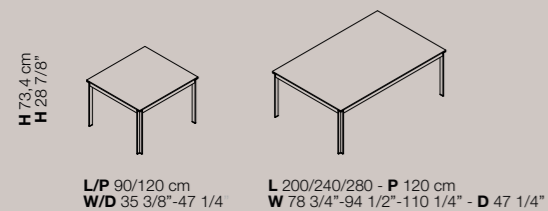

linear
design
smart

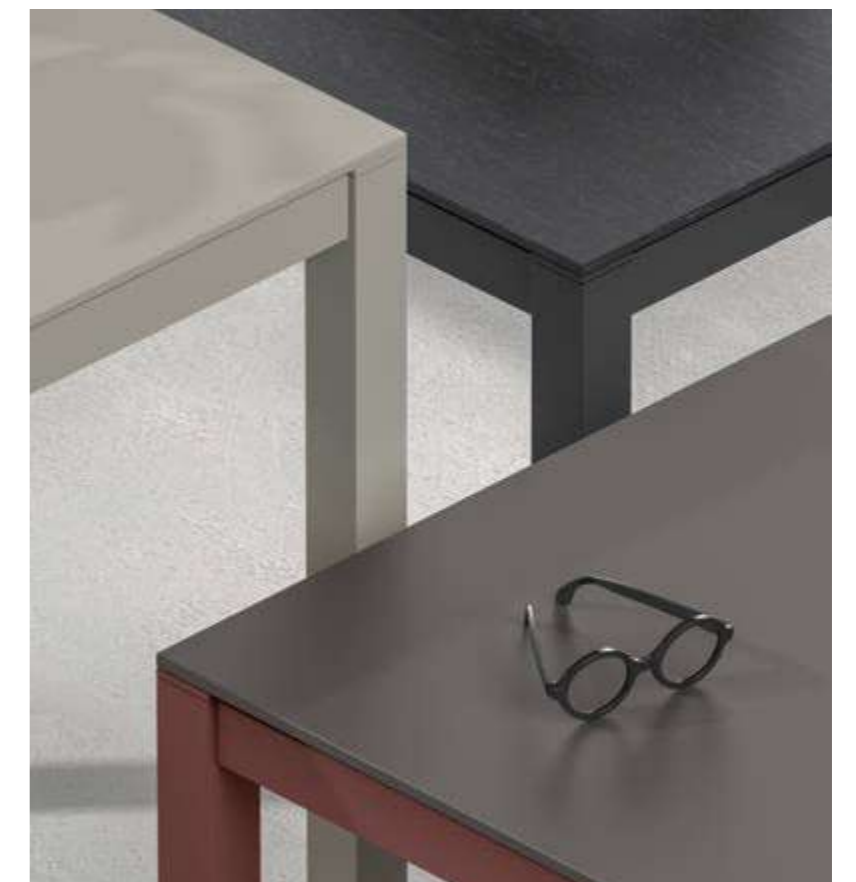

Atlante

adaptable
easy
linear



“ La collezione Atlante comprende tavoli riunione semplici e lineari. ”

Atlante's collection includes simple and straightforward meeting tables.

La collection Atlante comprend des tables de réunion simples et linéaires.

La colección Atlante incluye mesas de reuniones sencillas y lineales.

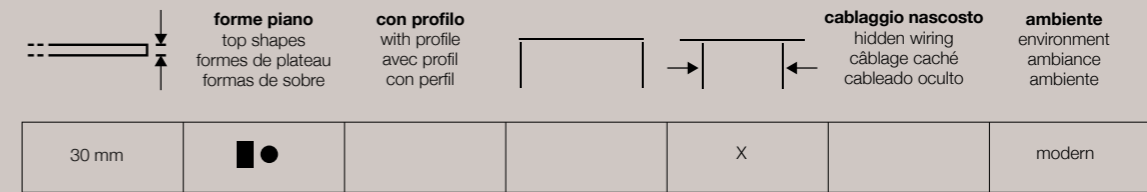

Finiture | Finishes | Finitions | Acabados

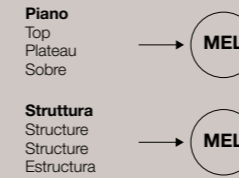

Tavoli riunione | Meeting tables | Tables de réunion | Mesas de juntas

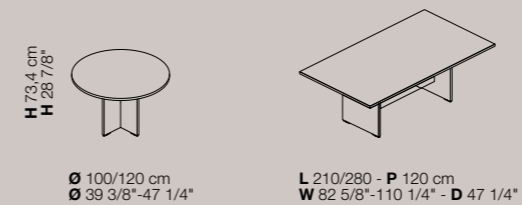

Tavoli



“ I tavoli con basamento in metallo, si adattano ad ogni tipo di ambiente. I basamenti sono sia quadrati che circolari, e si abbinano a piani di diverse forme: quadrata, rettangolare, rotonda e a botte. ”



Tables with metal base, match any type of environment. Bases can be both square and circular, combined with tops of different shapes: square, rectangular, round, barrel shaped.

Les tables à base métallique, s'adaptent à tout type d'environnement. Les bases sont à la fois carrées et rondes, combinées avec des plateaux de différentes formes: carré, rectangulaire, rond, tonneau.

Las mesas con base de metal, son adecuadas para cualquier tipo de ambiente. Las bases son tanto cuadradas como redondas, combinadas con sobres de diferentes formas: cuadradas, rectangulares, redondas, de barril.

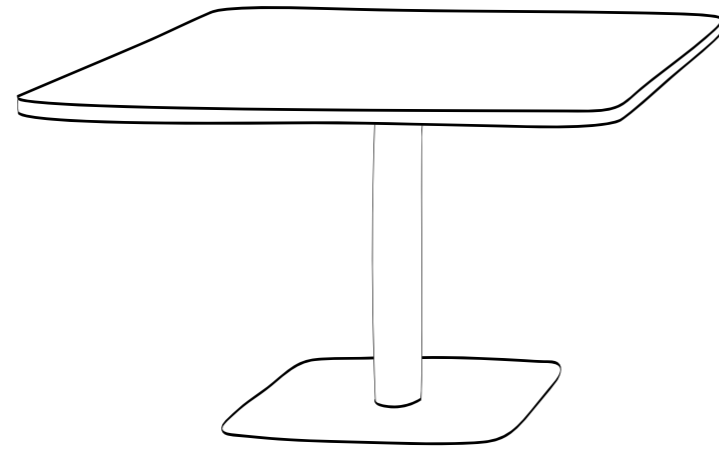

Tavoli con basamento	18 30 40 60 mm		X		X		modern managerial
----------------------	----------------------	--	---	--	---	--	---------------------

Finiture | Finishes | Finitions | Acabados

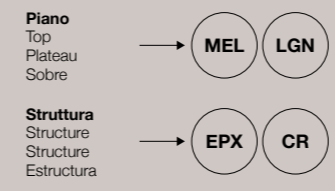

Tavoli | Tables | Tables | Mesas

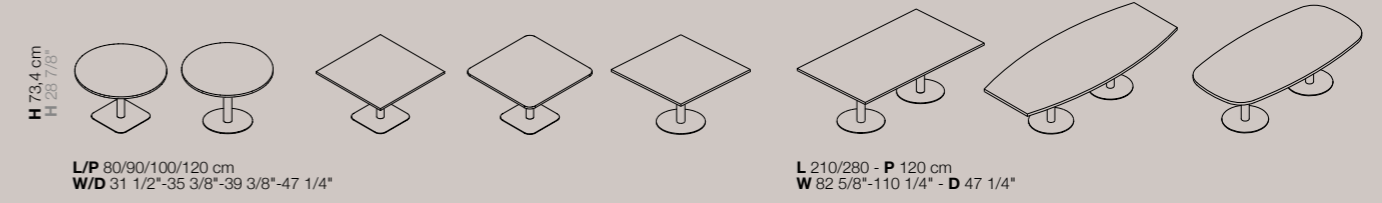



materiali e finiture

MEL

Melaminico

Melamine | Mélaminé | Melaminico

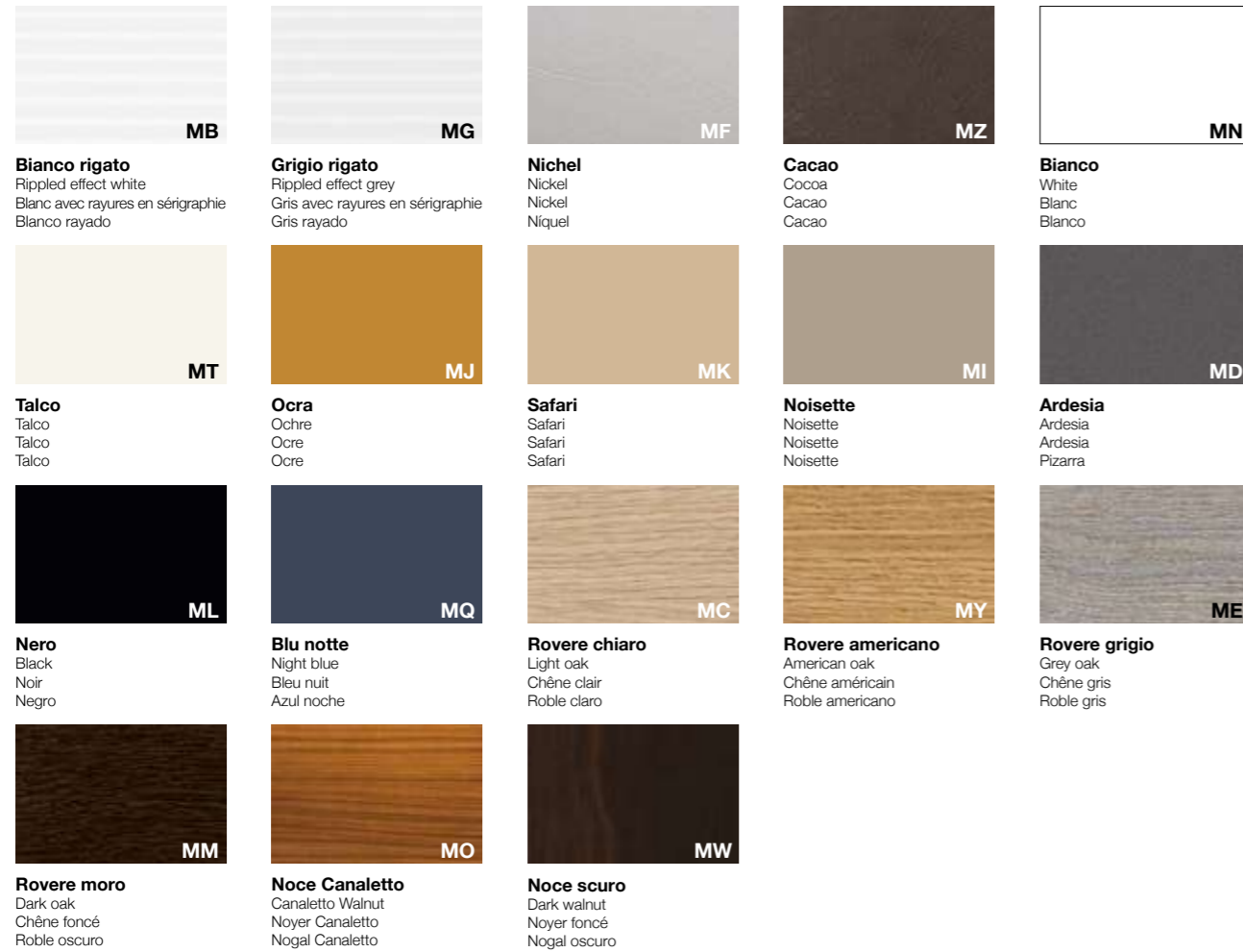

LGN

Legno

Wood | Bois | Madera

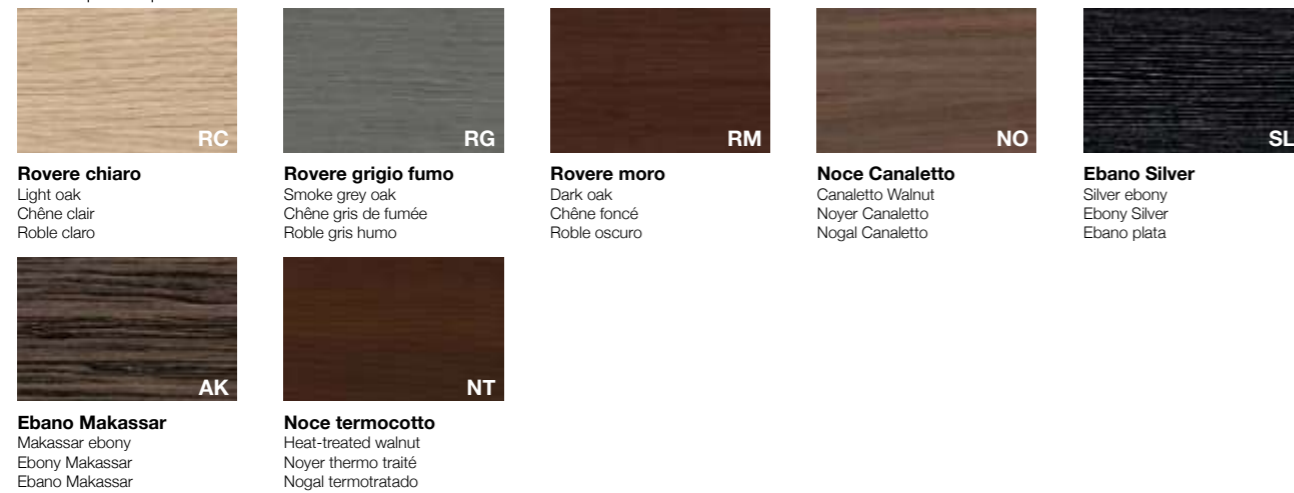

FNX

Fenix

Fenix | Fenix | Fenix

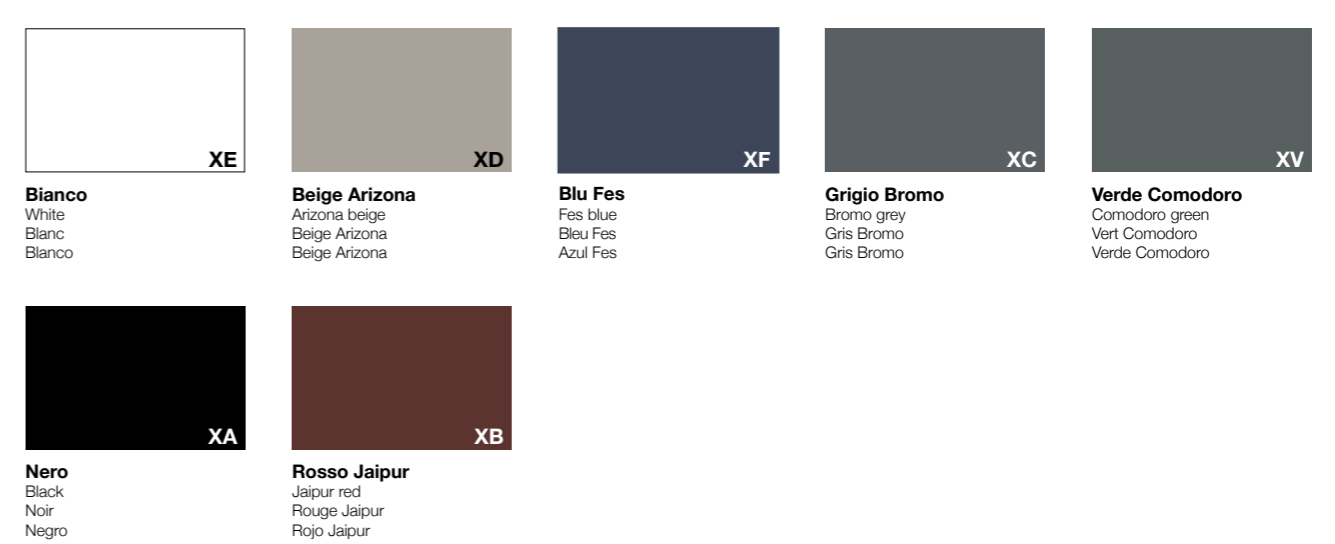

VTR

Vetro (anche antimpronta NFG)

Glass (also antifinger NFG) | Verre (également antitaches) | Vidrio (también anti-huella)

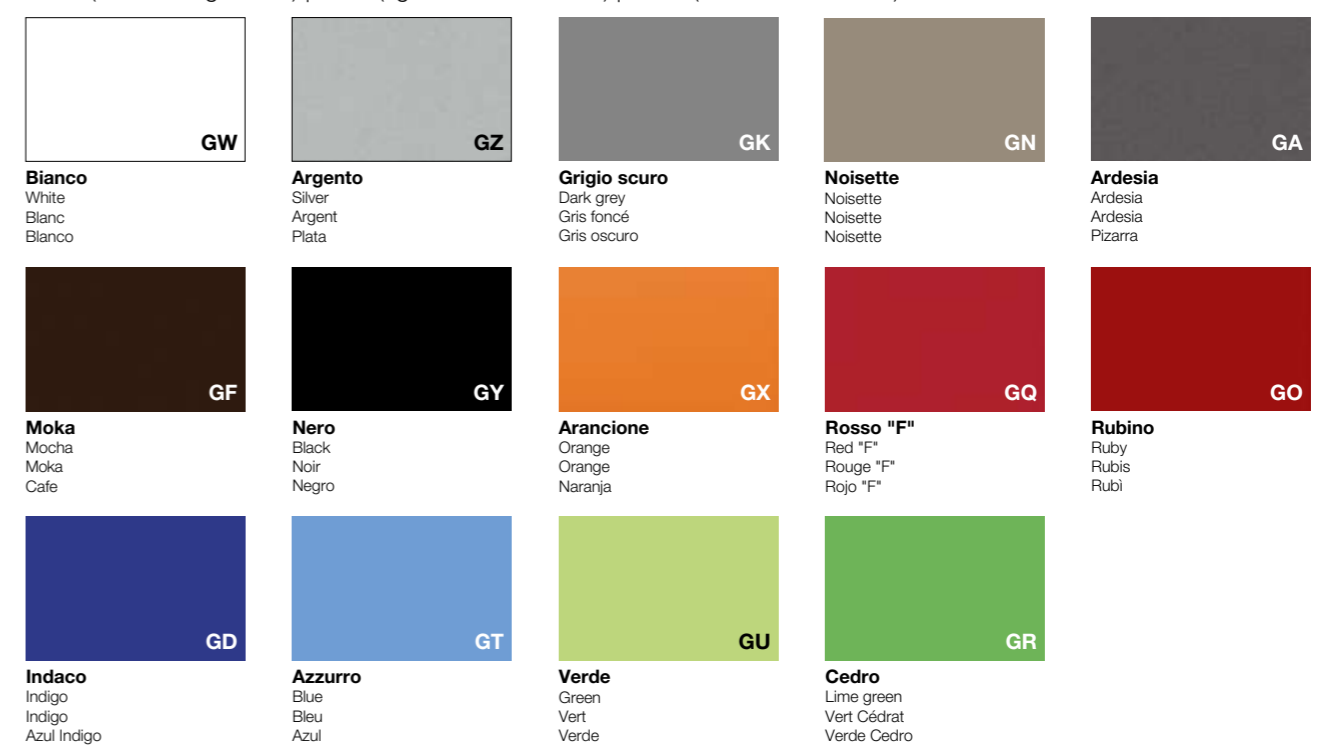

GRES

Gres porcellanato

Porcelain tiles | Grès cérame | Gres porcelánico



Nero
Black
Noir
Negro



Basalt
Basalt
Basalt
Basalt



Calacatta
Calacatta
Calacatta
Calacatta



Pulpis
Pulpis
Pulpis
Pulpis



Corten
Corten
Corten
Corten

CUO

Cuoio

Leather | Cuir | Cuero

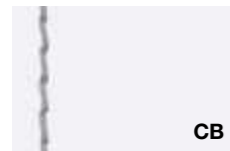

Bianco
White
Blanc
Blanco



Alluminio
Aluminium
Aluminium
Aluminio



Nero
Black
Noir
Negro



Testa di moro
Brown
Tete de maure
Marron oscuro



Caramello
Caramel
Caramel
Caramelo



Arancione
Orange
Orange
Naranja

GRES

Gres porcellanato

Porcelain tiles | Grès cérame | Gres porcelánico



Nero
Black
Noir
Negro



Basalt
Basalt
Basalt
Basalt



Calacatta
Calacatta
Calacatta
Calacatta



Pulpis
Pulpis
Pulpis
Pulpis



Corten
Corten
Corten
Corten

OSB



OSB
OSB
OSB
OSB

EPX

Epossidico

Epoxy | Époxy | Epoxi

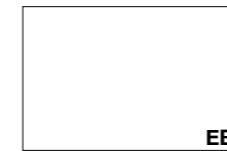

Bianco
White
Blanc
Blanco

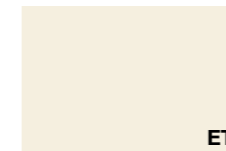

Talco
Talco
Talco
Talco

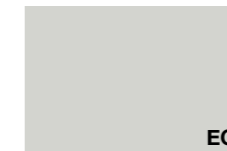

Grigio
Grey
Gris
Gris



Beige Arizona
Arizona beige
Beige Arizona
Beige Arizona



Noisette
Noisette
Noisette
Noisette



Safari
Safari
Safari
Safari



Rame
Copper
Cuivre
Cobre



Rosso Jaipur
Jaipur red
Rouge Jaipur
Rojo Jaipur



Bronzo
Bronze
Bronze
Bronze



Blu notte
Night blue
Bleu nuit
Azul noche



Grigio Bromo
Bromo grey
Gris Bromo
Gris Bromo



Ardesia
Ardesia
Ardesia
Pizarra



Verde Comodoro
Comodoro green
Vert Comodoro
Verde Comodoro



Nero
Black
Noir
Negro

CRM

Acciaio inox

Stainless steel | Acier inoxydable | Acero inoxidable



Lucido
Polished
Poli
Pulido



Brill
Brill
Brill
Brill

AL

Alluminio

Aluminium | Aluminium | Aluminio



Alluminio
Aluminium
Aluminium
Aluminio

Ambiente e sicurezza | Environment and safety | Environnement et sécurité | Medio ambiente y seguridad

Alea utilizza per i suoi prodotti e i suoi imballi materiali facilmente separabili e riciclabili.
Nella produzione dei suoi manufatti, Alea si impegna ad utilizzare materiali legnosi FSC e pannelli a base di legno con certificazione CARB2. I pannelli CARB2 presentano un rilascio di formaldeide inferiore rispetto al pannello E1 comunemente utilizzato (classe E1 secondo il DM 10/10/2008).

Alea uses materials that are easy to separate and recycle for its products and packaging.
Alea is committed to using FSC wood-based materials and CARB2-certified wood-based panels.
CARB2 panels have a lower formaldehyde release than the commonly used E1 panel (class E1 according to DM 10/10/2008).

Alea utilise des matériaux facilement séparables et recyclables pour ses produits et ses emballages.
Dans la production de ses produits, Alea s'engage à utiliser des matériaux en bois FSC et des panneaux à base de bois avec la certification CARB2. Les panneaux CARB2 dégagent moins de formaldéhyde que le panneau E1 couramment utilisé (classe E1 selon DM 10/10/2008).

Para sus productos y embalajes, Alea utiliza materiales fácilmente separables y reciclables.
En la fabricación de sus productos, Alea se compromete a utilizar materiales de madera FSC y paneles de madera con certificación CARB2. Los paneles CARB2 tienen una menor liberación de formaldehído que el panel E1 comúnmente utilizado (clase E1 según DM 10/10/2008).

Concept, visual & graphic design

Alea marketing + communication

Design

Mirto Antonel

Art direction

Mirto Antonel

Si ringrazia M.artedesign

martedesign.it

AD/CACD/AD

Le finiture contenute nella stampa sono puramente indicative e non sono di riferimento per le forniture del prodotto
Due to the printing process, finishes shown in this document are for illustration only. The finish on the final item may differ slightly from the printed illustration.
Les finitions contenues dans l'impression sont purement indicatives et ne sont pas pertinentes pour les fournitures du produit.
Los acabados contenidos en la impresión son puramente indicativos y no son de referencia para los suministros del producto.

alea
aleaoffice.com



GLOBAL HEADQUARTERS AND SHOWROOM : Via Col de Rust, 19 - 33070 Sarone (PN) - Italia : Tel ++39 0434 777 333
email: info@aleaoffice.com **PARIS SHOWROOM** : 176 Avenue Charles de Gaulle 92200, Neuilly-sur-Seine - France **NORTH AMERICAN HEADQUARTERS** : Midtown 2, 3449 NE 1st Avenue L-32, Miami, FL 33137 - USA : Tel ++1 305 470 1200 - email: info@alea-usa.com
ALEA UK OFFICE AND SHOWROOM : 50-54 Clerkenwell Road, London EC1M 5PS - email: info@aleaoffice.com