

# alea

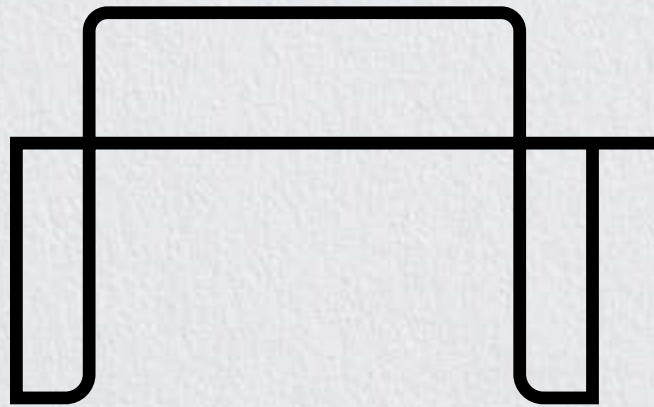

# Itube

---

workstations

## Segno

Itube è una collezione operativa dove l'estetica diventa funzione.

La sua struttura è definita da un segno continuo che interseca e sostiene il piano.

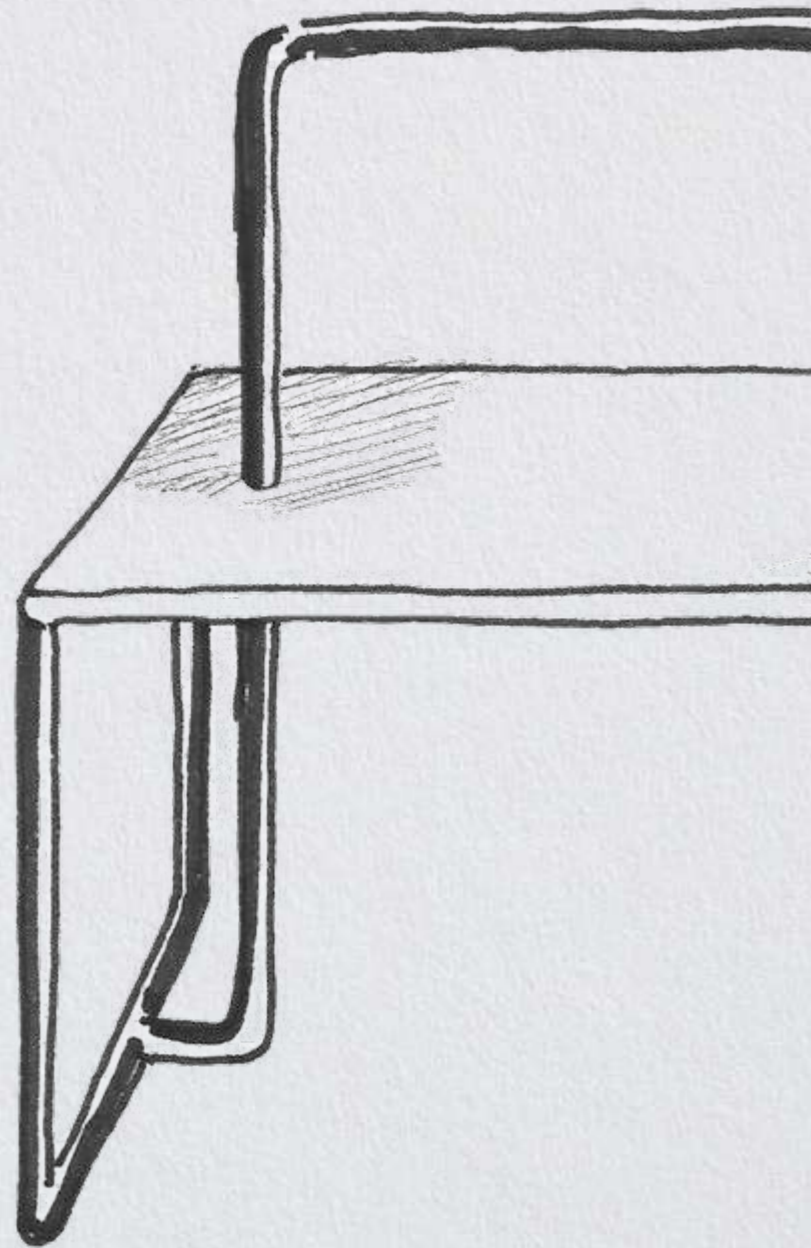

Itube is a collection where aesthetics become function. Its structure is a continuous sign that intersects and supports the top.

Itube est une collection où l'esthétique devient fonction. Sa structure est un signe continu qui s'entrecroise et soutient le sommet.

Itube es una colección en la que la estética se convierte en función. Su estructura es un signo continuo que se cruza y sostiene la parte superior.







---

## Caratteristiche

Il profilo tubolare in Itube è di diametro 35 mm e le sue gambe curvilinee rendono armoniosa la struttura.



**Bench** | Bench | Bench | Bench **Fin.** MN, EB, XE  
L 400 P 160 H 73,4 cm | W 157 1/2" D 63" H 29"



**Features** The tubular profile in Itube has a diameter of 35 mm (1 3/8") and the curved legs create a harmonious design.

**Caractéristiques** La forme tubulaire qui constitue Itube a un diamètre de 35 mm et ses pieds ont des rayons à chaque changement de direction de la structure.

**Características** El perfil tubular de Itube es de 35 mm de diámetro y sus patas curvilíneas hacen armoniosa la estructura.







## Funzionalità

Itube è stato pensato con diverse tipologie di accessori: mensole rettangolari o dalla forma organica, portapiante e vani portaoggetti incassati tra i semipiani.

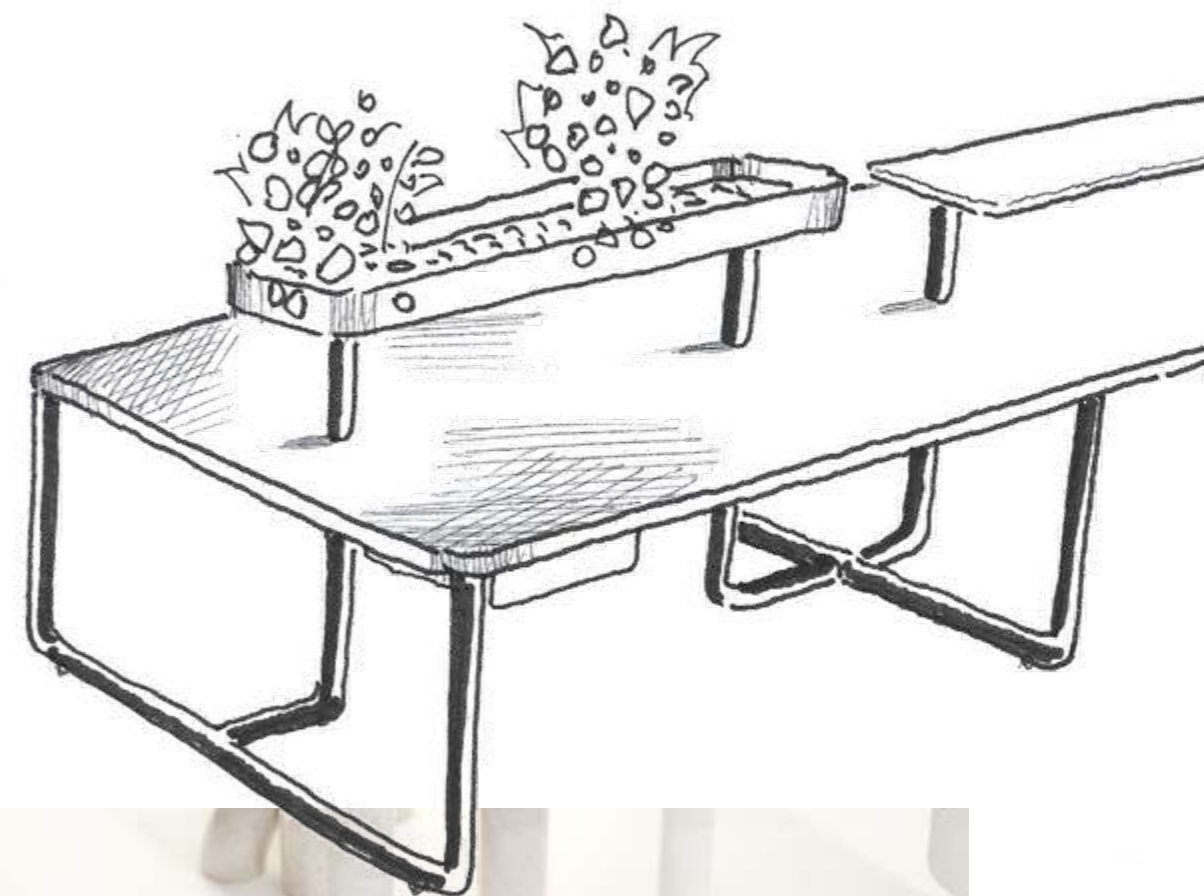



**Bench** | Bench | Bench | Bench **Fin.** XB, YB  
L 360 P 120 H 73,4 cm | W 141 3/4" D 47 1/4" H 29"



**Functionality** Itube has been designed with three types of accessories: rectangular or leaf shaped shelves, plant holders and built-in compartments.

**Fonctionnalité** Itube a été conçu avec trois types d'accessoires : des étagères rectangulaires ou de forme organique, des porte-plantes et des bacs encastrés entre demi-plateaux.

**Funcionalidad** Itube se ha diseñado con tres tipos de accesorios: estantes rectangulares o de forma orgánica, jardineras y guanteras empotradas entre los sobres.





**Bench** | Bench | Bench | Bench **Fin.** MK, XB, YB, DC  
L 180 P 160 H 73,4 cm | W 70 7/8" D 63" H 29"

---

## Altezze

Il tubo che attraversa soprapiano il bench è disponibile in due dimensioni: a ponte (69,4 cm) e a screen (40 cm).











**Heights** The tube that crosses the bench above the table top is provided in two different heights: bridge high (69,4 cm, 27 3/8", above the floor) and screen high (40 cm, 15 3/4").

**Hauters** Le tube qui traverse le bench au-dessus du plateau est fourni en deux hauteurs différentes : pont (69,4 cm au-dessus du sol) et écran (40 cm).

**Alturas** El tubo que atraviesa la encimera, sobre mesa, está disponible en dos alturas: puente (69,4 cm) y separator (40 cm).

**Bench** | Bench | Bench | Bench **Fin.** ML, EN, DI  
**L** 280 **P** 160 **H** 73,4 cm | **W** 110 1/4" **D** 63" **H** 29"







## Carattere

Itube diventa funky nelle sue declinazioni più decise. Perfetto per ambienti coworking dal taglio fresco e dinamico.



**Personality** Itube gets funky in its most unexpected proposal. Perfect for fresh and dynamic coworking environments.

**Caractère** Itube devient funky dans ses déclinaisons les plus fortes. Parfait pour les environnements de coworking frais et dynamiques.

**Personalidad** Itube se pone jocoso en sus declinaciones más extravagantes. Perfecto para entornos de coworking frescos y dinámicos.









**Bench** | Bench | Bench | Bench **Fin.** MK, EK, FF  
L 400 P 160 H 73,4 cm | W 157 1/2" D 63" H 29"

## Esclusivo

Itube introduce per la prima volta la tenda come elemento dinamico. Può anche essere utilizzata per separare postazioni di lavoro, cosicché il lavoratore possa definire il proprio spazio.

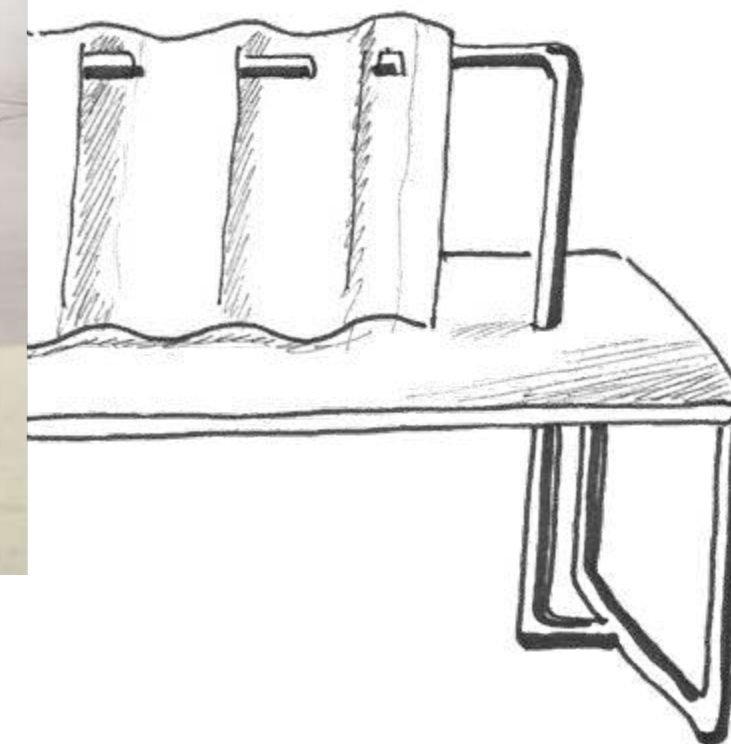





**Exclusivo** Itube introduces the curtain for the first time as a dynamic element. Used to separate workstations, it enables users to define their own space.

**Exclusif** Itube présente pour la première fois le rideau comme un élément dynamique. Il peut séparer les postes de travail ou non, créant ainsi une interaction avec le travailleur dans la définition de son espace.

**Exclusivo** Itube introduce por primera vez la cortina como elemento dinámico. También puede utilizarse para separar puestos de trabajo, de modo que el trabajador pueda definir su propio espacio.





## Lineare

Una delle declinazioni della collezione è il bench lineare. Si prevede che gli utenti si posizionino da un lato soltanto e questo rende il bench particolarmente adatto ad essere collocato fronte finestra o parete. Si addice ad ambienti universitari e biblioteche.

**Linear** One of the proposals of this collection is the linear bench. Users can sit on the same side, making it suitable near windows or walls, and especially in university environments and libraries.

**Linéaire** L'une des déclinaisons de la collection est le bench linéaire. Sa particularité réside dans le fait qu'il accueille l'utilisateur d'un seul côté, ce qui le rend particulièrement adapté pour se positionner en face d'une fenêtre ou à un mur, et il convient également aux environnements universitaires et aux bibliothèques.

**Lineal** Una de las declinaciones de la colección es el bench lineal. Está previsto que los usuarios se sienten en un sólo lado y esto hace que el bench sea especialmente adecuado para colocarlo frente a una ventana o una pared. Es apto para entornos universitarios y bibliotecas.

**Bench** | Bench | Bench | Bench **Fin.** XC, YC  
L 360 P 90 H 73,4 cm | W 141 3/4" D 35 3/8" H 29"







Tavolo | Table | Mesa Fin. MZ, EZ  
L 280 P 120 H 73,4 cm | W 110 1/4" D 47 1/4" H 29"





**Tavolo** | Table | Mesa **Fin.** Min. EB  
 L 280 P 120 H 73,4 cm | W 110 1/4" D 47 1/4" H 29"

## Tavoli

Le curve che caratterizzano la struttura si riflettono anche nei piani e si ritrovano nelle forme ovoidale, rettangolare e tonda.



**Tables** The curves that characterise the structure also define the rectangular, oval and round table tops.

**Tables** Itube a été conçu avec trois types d'accessoires : des étagères rectangulaires ou de forme organique, des porte-plantes et des bacs encastrés entre demi-plateaux.

**Tablas** Las curvas que caracterizan la estructura se reflejan en los sobes también y se encuentran en las formas ovalizada, rectangular y redonda.





**Tavolo** | Table | Mesa **Fin.** MIN, EB / XB, YB  
Ø 120 H 73,4 cm | Ø 47 1/4" H 29"



## Scrivanie

La scrivania completa l'offerta della collezione Itube.

Le sue linee leggere e funky contribuiscono ad alleggerire l'atmosfera circostante.

**Executive** The desk completes the Itube collection offer. With its light, unique lines, it lightens the tone of the workspace environment.



**Scrivanie** | Desk | Bureau | Mesa **Fin.** XV, YV  
L 200 P 90 H 73,4 cm | W 78 3/4" D 35 3/8" H 29"

**Dattilo** | Return | Retour | Ala **Fin.** XV, YV  
L 120 P 60 H 73,4 cm | W 47 1/4" D 23 5/8" H 29"

**Bureaux** Le bureau complète l'offre de la collection Itube. Avec ses lignes légères et funky, il allège le ton de l'espace de travail.

**Escritorio** El escritorio completa la oferta de la colección Itube. Sus líneas ligeras y extravagantes contribuyen a aligerar el ambiente.



## Composizioni

Itube prevede l'aggiunta anche di screen puntaspilli (spessore 30 mm) frontali, direttamente fissati al piano, e laterali, in appoggio e per questo facilmente removibili.



**Compositions** Itube also includes frontal pinnable screens (30 mm, 1 1/4", thick), fixed onto the desktop, and lateral movable screens supported by round metal bases.

**Compositions** Itube prévoit l'ajoute d'écrans frontaux punaisables (ép. 30 mm), directement fixés au plateau, et latéraux en appui donc facilement amovibles.

**Composiciones** Itube también prevé la adición de paneles separadores pinchables (30 mm de espesor) frontales, que se fijan directamente al sobre, y laterales que se apoyan y desmontan fácilmente.

**Bench 2P** | Bench 2P | Bench 2P | Bench 2P **Fin.** MK, EK, DC  
L 200 P 160 H 73,4 cm | W 78 3/4" D 63" H 29"

**Bench 4P** | Bench 4P | Bench 4P | Bench 4P **Fin.** MK, EK, DC  
L 400 P 160 H 73,4 cm | W 157 1/2" D 63" H 29"



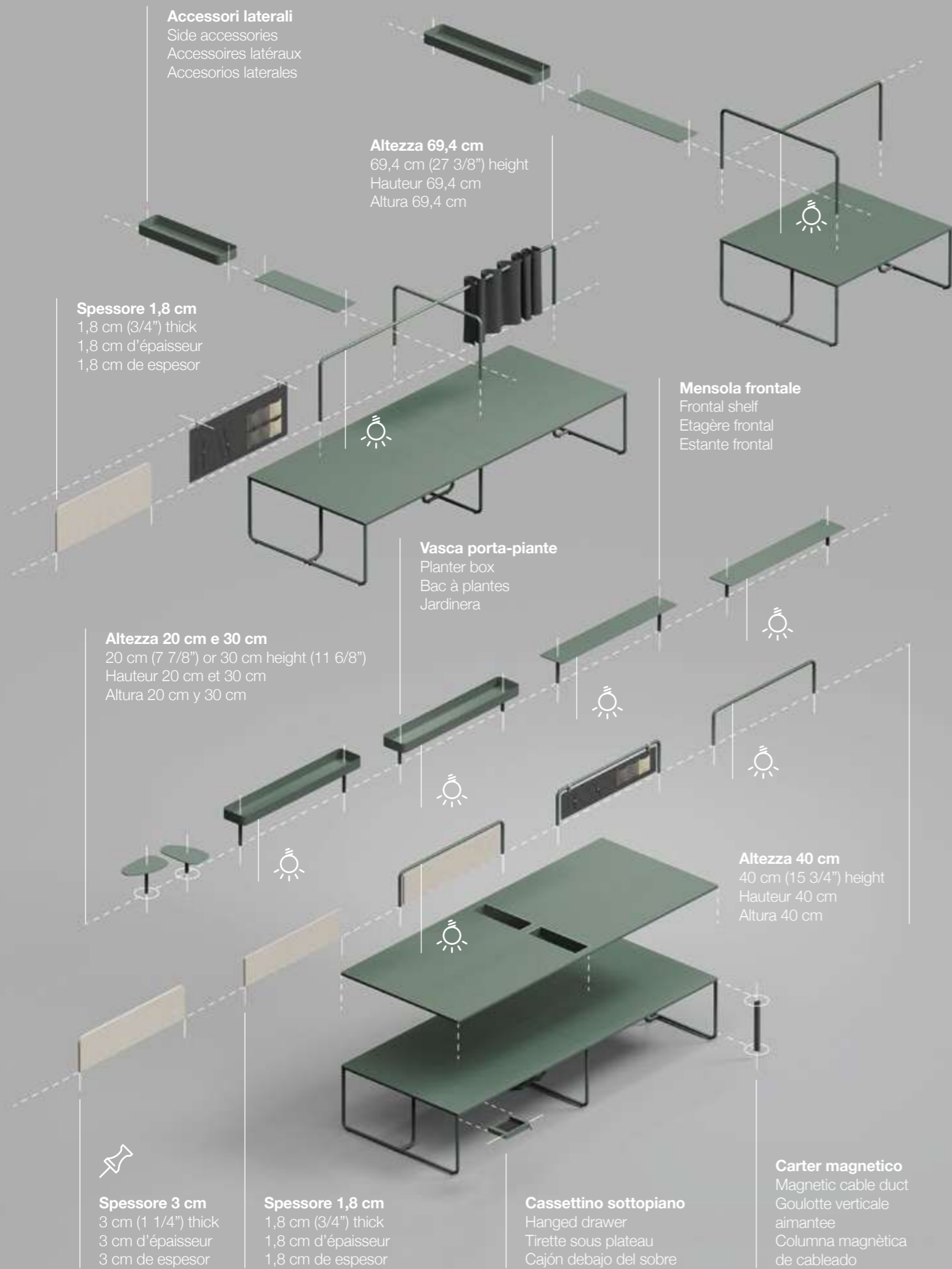



**Piani** | Desk tops | Plateaux | Sobres

Spessore 3 cm | 3 cm (1 1/4") thick | 3 cm d'épaisseur | 3 cm de espesor

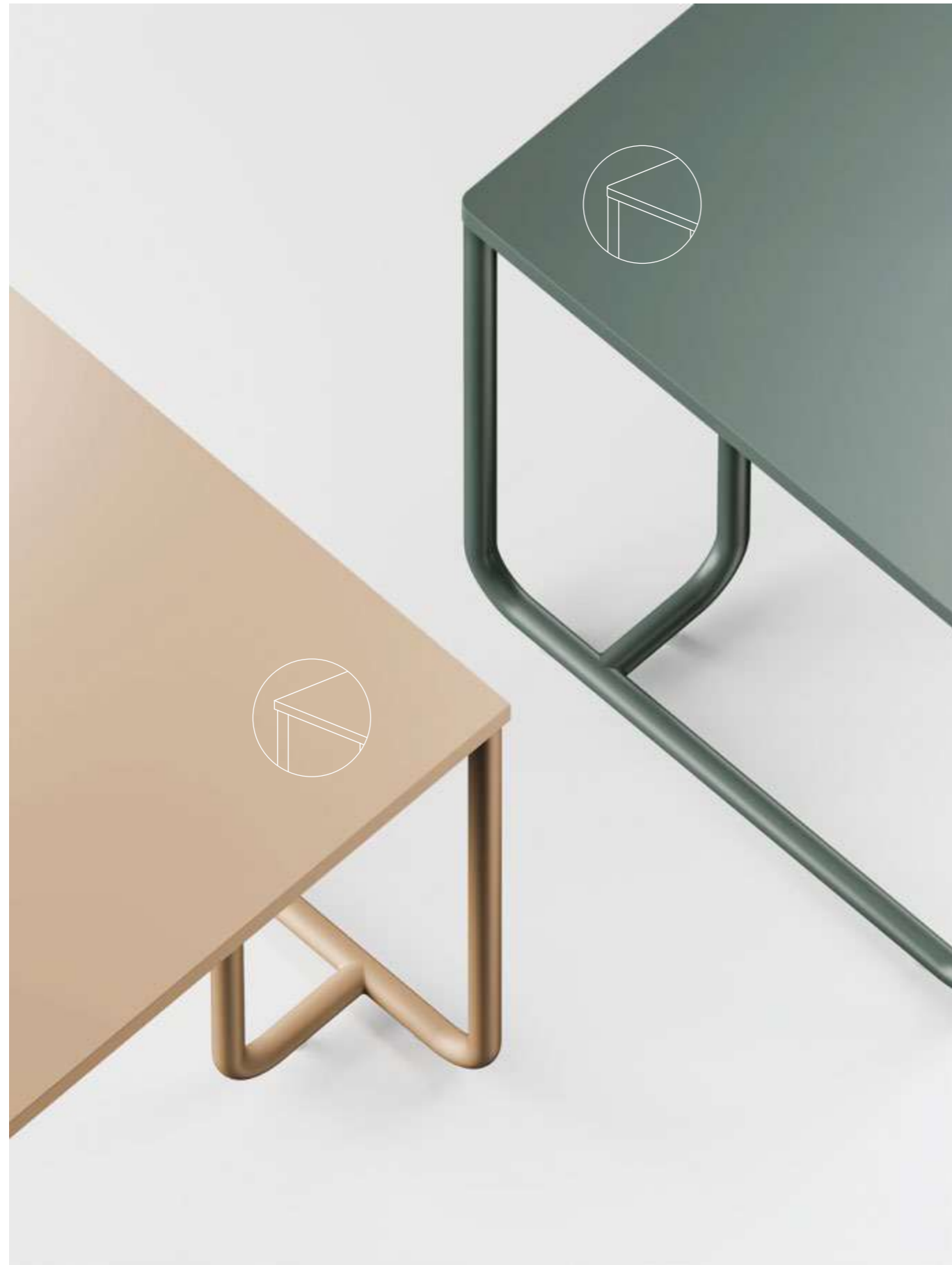

**Piani** | Desk tops | Plateaux | Sobres

Spessore 3 cm | 3 cm (1 1/4") thick | 3 cm d'épaisseur | 3 cm de espesor

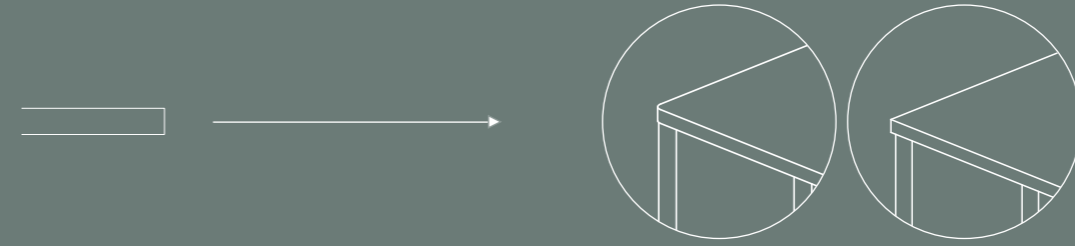

**Scrivanie/tavoli** | Desks/tables | Bureaux/tables | Mesas

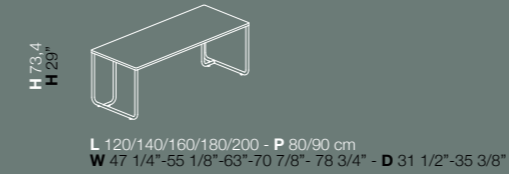

**Dattilo** | Returns | Retours | Alas

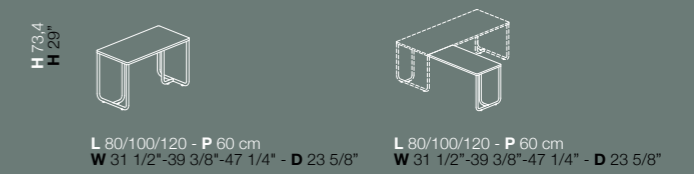

**Bench lineare** | Linear bench | Banc linéaire | Banco lineal

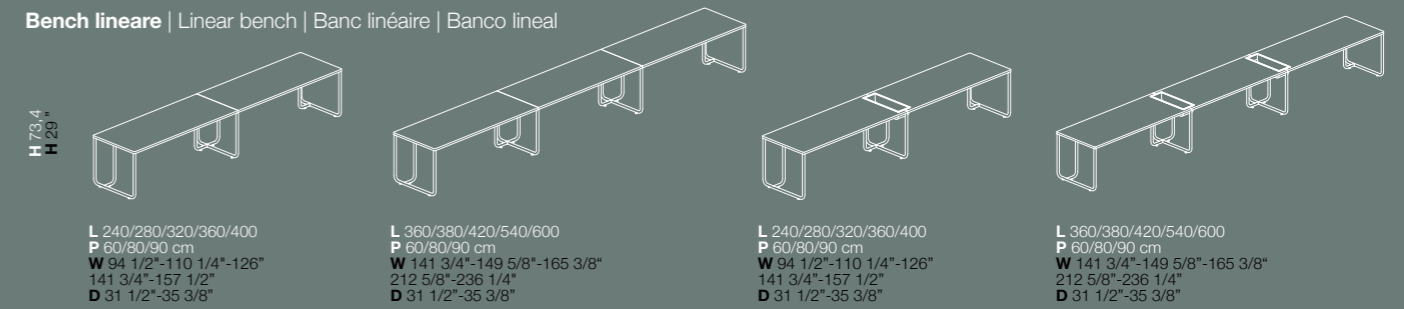

**Bench** | Bench | Bench | Bench

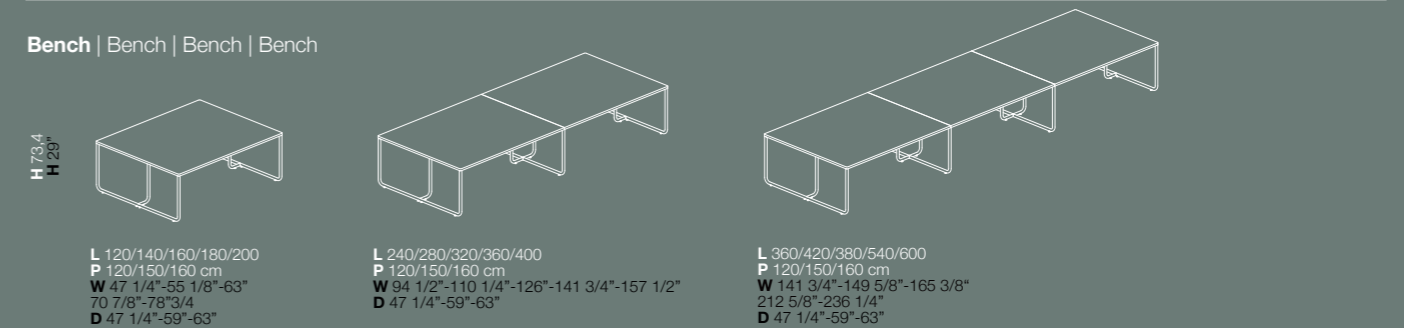

**Bench** | Bench | Bench | Bench

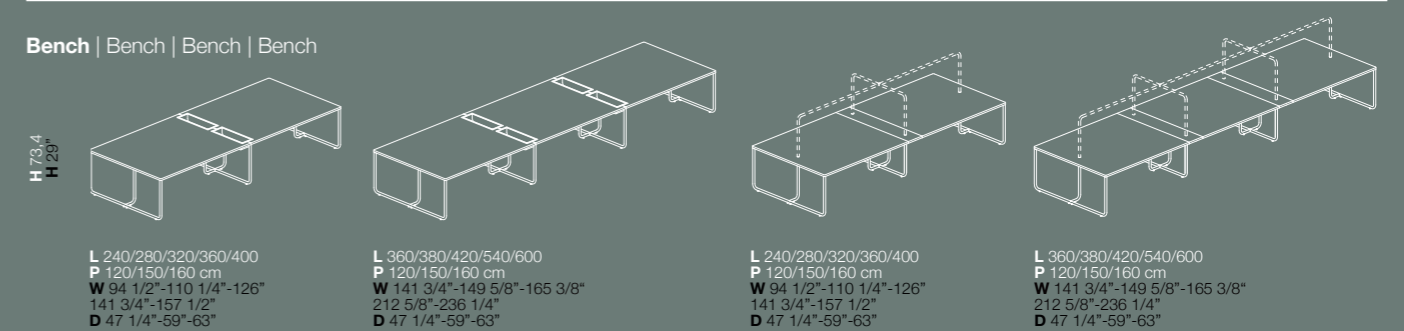

**Tavoli riunione** | Meeting tables | Tables de réunion | Mesas de juntas

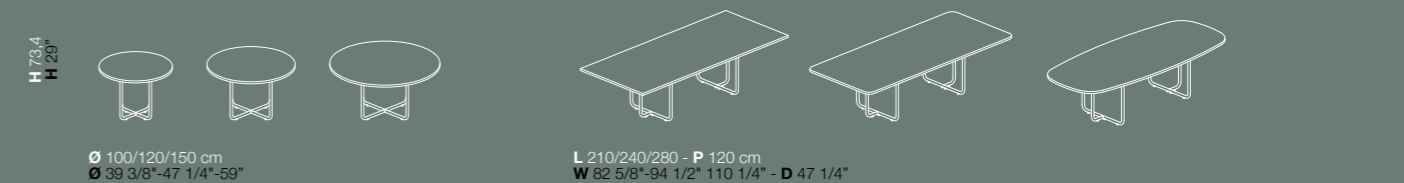

















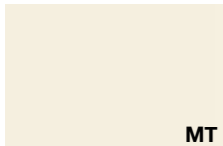

# Finiture | Finishes | Finitions | Acabados

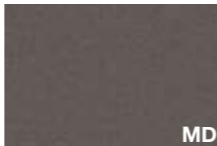
## MEL

### Melaminico

Melamine | Mélaminé | Melaminico









 <b>MB</b>	 <b>MG</b>	 <b>MF</b>	 <b>MZ</b>	 <b>MN</b>
<b>Bianco rigato</b> Rippled effect white Blanc avec rayures en sérigraphie Blanco rayado	<b>Grigio rigato</b> Rippled effect grey Gris avec rayures en sérigraphie Gris rayado	<b>Nichel</b> Nickel Nickel Niquel	<b>Cacao</b> Cocoa Cacao Cacao	<b>Bianco</b> White Blanc Blanco
 <b>MT</b>	 <b>MJ</b>	 <b>MK</b>	 <b>MI</b>	 <b>MD</b>
<b>Talco</b> Talco Talco Talco	<b>Ocra</b> Ochre Ocre Ocre	<b>Safari</b> Safari Safari Safari	<b>Noisette</b> Noisette Noisette Noisette	<b>Ardesia</b> Ardesia Ardesia Pizarra
 <b>ML</b>	 <b>MQ</b>	 <b>MC</b>	 <b>MY</b>	 <b>ME</b>
<b>Nero</b> Black Noir Negro	<b>Blu notte</b> Night blue Bleu nuit Azul noche	<b>Rovere chiaro</b> Light oak Chêne clair Roble claro	<b>Rovere americano</b> American oak Chêne américain Roble americano	<b>Rovere grigio</b> Grey oak Chêne gris Roble gris
 <b>MM</b>	 <b>MO</b>	 <b>MW</b>		
<b>Rovere moro</b> Dark oak Chêne foncé Roble oscuro	<b>Noce Canaletto</b> Canaletto Walnut Noyer Canaletto Nogal Canaletto	<b>Noce scuro</b> Dark walnut Noyer foncé Nogal oscuro		

## FNX

### Fenix

Fenix | Fenix | Fenix



 <b>XE</b>	 <b>XD</b>	 <b>XF</b>	 <b>XC</b>	 <b>XV</b>
<b>Bianco</b> White Blanc Blanco	<b>Beige Arizona</b> Arizona beige Beige Arizona Beige Arizona	<b>Blu Fes</b> Fes blue Bleu Fes Azul Fes	<b>Grigio Bromo</b> Bromo grey Gris Bromo Gris Bromo	<b>Verde Comodoro</b> Comodoro green Vert Comodoro Verde Comodoro
 <b>XA</b>	 <b>XB</b>			
<b>Nero</b> Black Noir Negro	<b>Rosso Jaipur</b> Jaipur red Rouge Jaipur Rojo Jaipur			



## FLT

### Feltro

Felt | Rasantie | Fieltro



**Sabbia**  
Cream  
Sable  
Arena



**Grigio chiaro**  
Light grey  
Gris clair  
Gris claro

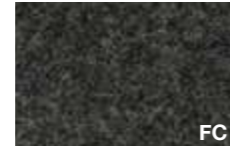

**Grigio scuro**  
Dark grey  
Gris foncé  
Gris oscuro



**Blu melange**  
Melange blu  
Bleu mélangé  
Azul melange



**Verde scuro**  
Dark green  
Vert foncé  
Verde oscuro

TND



**Marrone**  
Brown  
Marron  
Marrón



**Rosso bordeaux**  
Burgundy red  
Rouge bordeaux  
Rojo burdeos

## TES

### Tessuto

Fabric | Tissu | Tejido



**Beige**  
Beige  
Beige  
Beige

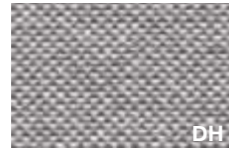

**Grigio chiaro**  
Light grey  
Gris clair  
Gris claro



**Ardesia**  
Ardesia  
Ardesia  
Pizarra



**Blu avio**  
Avio blue  
Bleu avio  
Azul avio



**Acquamarina**  
Acquamarine  
Aigue-marine  
Aguamarina

SCR



**Verde primavera**  
Spring green  
Vert printemps  
Verde primavera



**Salvia**  
Sage  
Sauge  
Salvia



**Arancio**  
Orange  
Orange  
Naranja



**Corallo**  
Coral  
Corail  
Coral

## EPX

### Epossidico

Epoxy | Époxy | Epoxi



**Bianco**  
White  
Blanc  
Blanco

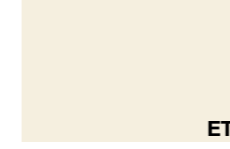

**Talco**  
Talco  
Talco  
Talco

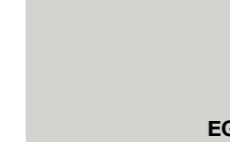

**Grigio**  
Grey  
Gris  
Gris

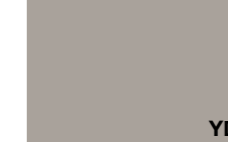

**Beige Arizona**  
Arizona beige  
Beige Arizona  
Beige Arizona



**Noisette**  
Noisette  
Noisette  
Noisette

STRU



**Safari**  
Safari  
Safari  
Safari



**Rame**  
Copper  
Cuivre  
Cobre

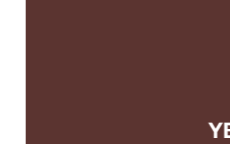

**Rosso Jaipur**  
Jaipur red  
Rouge Jaipur  
Rojo Jaipur



**Bronzo**  
Bronze  
Bronze  
Bronze



**Blu notte**  
Night blue  
Bleu nuit  
Azul noche



**Grigio Bromo**  
Bromo grey  
Gris Bromo  
Gris Bromo



**Ardesia**  
Ardesia  
Ardesia  
Pizarra



**Verde Comodoro**  
Comodoro green  
Vert Comodoro  
Verde Comodoro



**Nero**  
Black  
Noir  
Negro

## Applicazioni finiture

Finish application | Application finitions | Aplicacion acabados



**TOP**  
Top  
Plano  
Sobre



**SCR**  
Screen  
Écran  
Panel



**STRU**  
Struttura  
Structure  
Structura



**TND**  
Tenda  
Curtain  
Rideau  
Cortina

**Le finiture contenute nella stampa sono puramente indicative e non sono di riferimento per le forniture del prodotto**

Due to the printing process, finishes shown in this document are for illustration only. The finish on the final item may differ slightly from the printed illustration.  
Les finitions contenues dans l'impression sont purement indicatives et ne sont pas pertinentes pour les fournitures du produit.  
Los acabados contenidos en la impresión son puramente indicativos y no son de referencia para los suministros del producto.



## **Ambiente e sicurezza** | Environment and safety | Environnement et sécurité | Medio ambiente y seguridad

Alea utilizza per i suoi prodotti e i suoi imballi materiali facilmente separabili e riciclabili.  
Nella produzione dei suoi manufatti, Alea si impegna ad utilizzare materiali legnosi FSC e pannelli a base di legno con certificazione CARB2. I pannelli CARB2 presentano un rilascio di formaldeide inferiore rispetto al pannello E1 comunemente utilizzato (classe E1 secondo il DM 10/10/2008).

Alea uses materials that are easy to separate and recycle for its products and packaging.  
Alea is committed to using FSC wood-based materials and CARB2-certified wood-based panels.  
CARB2 panels have a lower formaldehyde release than the commonly used E1 panel (class E1 according to DM 10/10/2008).

Alea utilise des matériaux facilement séparables et recyclables pour ses produits et ses emballages.  
Dans la production de ses produits, Alea s'engage à utiliser des matériaux en bois FSC et des panneaux à base de bois avec la certification CARB2. Les panneaux CARB2 dégagent moins de formaldéhyde que le panneau E1 couramment utilisé (classe E1 selon DM 10/10/2008).

Para sus productos y embalajes, Alea utiliza materiales fácilmente separables y reciclables.  
En la fabricación de sus productos, Alea se compromete a utilizar materiales de madera FSC y paneles de madera con certificación CARB2. Los paneles CARB2 tienen una menor liberación de formaldehído que el panel E1 comúnmente utilizado (clase E1 según DM 10/10/2008).

### **Concept & design**

Alea marketing + communication

### **Art director**

Mirto Antonel

### **Product design**

Mirto Antonel

### **Si ringrazia M.artedesign**

[martedesign.it](http://martedesign.it)

AL/CACD/AB

**Le immagini dei prodotti visibili all'interno di questo catalogo sono inserite a scopo puramente indicativo**  
The images of the products visible in this catalogue are included for information purposes only  
Les images des produits visibles dans ce catalogue sont incluses à titre informatif uniquement  
Las imágenes de los productos visibles en este catálogo se incluyen sólo con fines informativos



**alea**  
aleaoffice.com



**GLOBAL HEADQUARTERS AND SHOWROOM** : Via Col de Rust, 19 - 33070 Sarone (PN) - Italia : Tel ++39 0434 777 333  
email: info@aleaoffice.com **PARIS SHOWROOM** : 176 Avenue Charles de Gaulle 92200, Neuilly-sur-Seine - France **NORTH AMERICAN**  
**HEADQUARTERS** : Midtown 2, 3449 NE 1st Avenue L-32, Miami, FL 33137 - USA : Tel ++1 305 470 1200 - email: info@alea-usa.com  
**ALEA UK OFFICE AND SHOWROOM** : 50-54 Clerkenwell Road, London EC1M 5PS - email: info@aleaoffice.com