

Seipo Workspaces

Guida all'arredo degli spazi di lavoro contemporanei
Guide to furnishing contemporary workspaces

Edition 2020























Seipo Workspaces

Guida all'arredo degli spazi di lavoro contemporanei
Guide to furnishing contemporary workspaces

Edition 2020

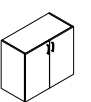
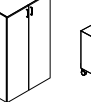
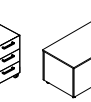
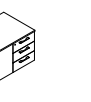

INDICE / TABLE OF CONTENTS

AZIENDA / COMPANY				6
STONE		 3,0	DESK MEETING CABINET SMALL TABLES RECEPTIONS	12
ROYAL	  	 3,8	DESK MEETING CABINET & DRAWERS CUBE	44
RING		 1,8 2,5 3,0	DESK BENCHES MEETING	68
BRIDGE		 1,8 2,5 3,0	DESK BENCHES MEETING	92
T-LEG	 	 2,5 3,0	DESK CALL MEETING	116
PANEL	 	 2,5 3,0	DESK BENCHES CALL MEETING	136
CABINET & DRAWERS	   		CABINET STANDARD 35-45 CABINET FULL 36-46 DOORS FOR STANDARD AND FULL CABINET CUBE - LOCKERS DRAWERS	160
TABLES	   		BAR ATTESA/WAITING RIBALTABILI/TILTING PIEGHEVOLI/FOLDING CHIUDIBILI/FOLDING MENSA/CANTEEN	188
FONOASSORBENZA BQ® BQ®SOUNDPROOFING			CABINE POSTAZIONI DI LAVORO PARETINE VERTICALI AUTOPORTANTI PANNELLI ORIZZONTALI A SOFFITTO PANNELLI ORIZZONTALI A SOFFITTO SU FILO ORIZZONTALE PANNELLI ORIZZONTALI A SOFFITTO SU FILO VERTICALE PANNELLI VERTICALI A PARETE PANNELLI VERTICALI SOSPESI SU FILO CORPI ILLUMINANTI QUADRI PHONE BOOTH	208



MOBILI
FURNITURE

IMBOTTITI
UPHOLSTERED

FONOASSORBENZA BQ®
BQ® SOUNDPROOFING

SEDIE E POLTRONE
CHAIRS AND ARMCHAIRS

Un'azienda impegnata a progettare il futuro

A company committed to designing the future

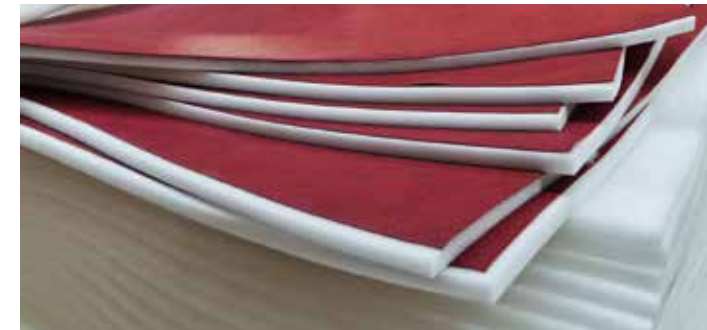
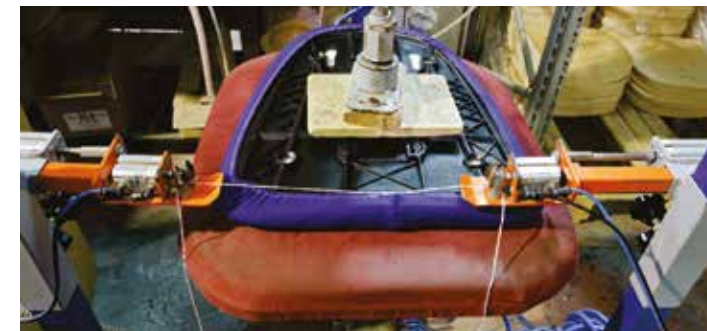

Dedicati alla qualità

Dalla nostra passione ed esperienza nel settore dell'arredo per ufficio, nel 1992 nasce SEIPO, un'azienda dinamica ed ambiziosa, impegnata nella produzione di sedute e complementi per ufficio e spazi pubblici, 100% Made in Italy. Siamo cresciuti e oggi siamo orgogliosi della nostra sede produttiva in Sicilia, che si estende in circa 7000 metri quadrati, dove il nostro prodotto viene progettato e realizzato interamente, utilizzando macchinari di ultimissima generazione.

Qui nascono le soluzioni destinate a soddisfare appieno le esigenze degli spazi di lavoro contemporanei: la **divisione mobili** studia, progetta e realizza le soluzioni ideali di arredamento per ufficio; la **divisione sedie** migliora il comfort mediante sedute innovative ad alto contenuto ergonomico; la **divisione BQ® Be quiet** si occupa di offrire risposte efficienti nel moderno settore della fono-assorbente. L'innovazione del prodotto, la ricerca della qualità e l'avanguardia nello sviluppo delle tecnologie sono gli obiettivi che guidano ed orientano costantemente il lavoro dei tecnici di SEIPO.

Dedicated to quality

Seipo started to conduct business in 1992 thanks to its passion and experience gained in the office furnishing sector, a dynamic and ambitious company engaged in the production of seatings and accessories for office and public spaces, 100% Made in Italy. We have grown and today we are proud of our production site in Sicily which covers about 7000 square meters, where our products are designed and entirely manufactured by means of the latest and most modern machinery. Solutions designed to fully satisfy the needs of contemporary work spaces are created: **the furniture division** studies, designs and implements ideal office furniture solutions; **the chairs division** improves comfort through innovative highly technological ergonomic seating; **the BQ® division Be quiet** offers efficient answers in the modern sound absorbing sector. Product innovation, the search for quality and the forefront of technology development are the goals that constantly guide the work of SEIPO'S technicians.

Ricerca e sviluppo, per innovare di più

Tutti i nostri prodotti, sia quelli di serie che quelli personalizzati, vengono progettati dal nostro ufficio tecnico interno e poi realizzati con materie prime italiane da primarie aziende del settore. Come nella migliore tradizione del Made in Italy, il prodotto Seipo coniuga tecnologia e cura artigianale, e viene sottoposto ad accurati test di controllo, in ogni singola fase del processo produttivo, per garantire sempre quella qualità, sicurezza e affidabilità che costituiscono la base del rapporto di fiducia con il mercato. Curiamo con la massima attenzione ogni particolare, dalla vite alla verniciatura, fino alle fasi di confezionamento. Grazie alla flessibilità dei nostri impianti, creati con il criterio dell'industria 4.0, possiamo rispondere in tempi molto contenuti a specifiche esigenze del cliente. Nascono così soluzioni complete dedicate ai target e agli ambienti più diversi: uffici, studi professionali, negozi, hotel, banche, ospedali, aeroporti, istituti scolastici, aziende pubbliche e private.

Research and development for innovation

All our products, both standard and customized are designed by our technical department and then manufactured with Italian raw materials from leading companies in the sector. As in the best Made in Italy tradition, Seipo products combine artisan technology and care and are subjected to accurate control tests in every single phase of our production process in order to ensure quality, safety and reliability that form the base of the relationship and trust with our partners. We give utmost attention to every detail, from the screw to the painting to the final phase regarding the packaging. Thanks to the flexibility of our machinery systems, created with the 4.0 industry criteria, we can respond very quickly to any customer's specific needs. This is how complete solutions are dedicated to target groups and the most diverse environments: offices, professional studios, shops, hotels, banks, hospitals, airports, educational institutions, public and private companies.

Tutta la nostra cura per la massima soddisfazione del cliente

All of our attention for our customer's maximum satisfaction



La nostra idea di servizio: dialogo ed efficienza

Il nostro obiettivo è fornire prodotti di alta qualità, con un elevato valore aggiunto in termini di funzionalità e design. Crediamo nell'importanza di ascoltare il nostro cliente e comprenderne esattamente le esigenze, per andare oltre le sue aspettative, proponendo soluzioni di valore sia per quanto riguarda la gamma dei prodotti sia per la qualità dei servizi offerti. La chiarezza, lo spirito di collaborazione, la disponibilità, la volontà di conseguire alti livelli di affidabilità sono i valori che stanno alla base di ogni nostra azione: così facendo abbiamo raggiunto ottimi risultati, creando, al contempo, un nuovo modo di interpretare il lavoro. Il servizio SEIPO prevede la consulenza da parte di tecnici specializzati, che valutano il progetto, offrendo soluzioni di design e assoluta qualità; dopo la stesura della planimetria, viene realizzato il progetto di arredamento, mediante software CAD all'avanguardia e immagini 3D. La nostra visione a lungo termine è quella di continuare a creare prodotti sempre più efficienti nelle nostre tre divisioni, arredo, sedute e acustica, per fornire risposte complete agli spazi di oggi e di domani.



Our idea of service: dialogue and efficiency

Our goal is to provide high quality products with an elevated added value in terms of functionality and design. We believe in the importance of listening to our customers and to understand their exact needs in order to go beyond their expectations, suggesting valuable solutions regarding our product range and the quality of our services. Our clarity, spirit of collaboration, availability and our will to achieve high levels of reliability are the values that underpin our every action: in so doing we have achieved excellent results, creating, at the same time, a new way of interpreting business. SEIPO will provide you with consultation by means of its specialized technicians, who will evaluate your project and offer absolute quality design solutions; after drawing up the plan, your furnished project is created by using software State-of-the-art CAD and 3D images. Our long term vision is to continue to create more and more efficient products in our three divisions, furniture, seating and acoustics, in order to provide complete answers to today's and tomorrow's spaces.



Siamo formati per l'eccellenza

SEIPO dà grande importanza alla formazione e alla specializzazione di tutte le proprie risorse umane. Attraverso meeting specifici organizzati all'interno della nostra struttura, realizziamo un capillare lavoro di formazione ed aggiornamento in modo da comprendere le reali esigenze del mercato, per rispondere al meglio alle necessità degli utenti. In ogni prodotto SEIPO c'è l'impegno, la competenza e l'esperienza di persone che lavorano in perfetta sinergia, impegnate con ruoli diversi nello studio, nella progettazione e nella realizzazione di prodotti che sappiano davvero fare la differenza e proporre soluzioni ottimali. È per tutte queste ragioni che noi di SEIPO siamo in grado di realizzare prodotti innovativi ed essere, in stretta collaborazione con il cliente, un partner sempre propositivo.



We are trained for excellence

SEIPO gives great importance to the training and specialization to all of its human resources. Through specific meetings organized within of our company, we carry out a capillary work of formation and updating so as to understand the real needs of the market, to better respond to the end user's needs. In each SEIPO product there is the commitment, competence and experience of people who work in perfect synergy, with different roles in the study, in the planning and in the realization of products that really make a difference and propose optimal solutions. It is for all the above mentioned reasons that we at SEIPO are able to manufacture innovative products and stay in close collaboration with our customer, a propositional partner always.

Il valore di essere riconosciuti

The value of being recognized



La logistica: puntuale ed affidabile

La cura del prodotto trasportato e la certezza dei tempi di consegna sono per noi espressione di qualità globale e servizio al cliente. Per questo tutta la logistica è gestita internamente dall'azienda, con mezzi propri. Il nostro servizio programma tutti gli aspetti di trasporto/consegna per soddisfare le diverse esigenze, dalla fase di carico fino alla consegna finale presso il nostro cliente, attraverso una flotta di mezzi aziendali di varie dimensioni che coprono l'intero territorio italiano settimanalmente. Tutti gli automezzi sono dotati di un avanzato sistema di GPRS per la localizzazione immediata degli autocarri. Anche il servizio post-vendita è espressione della nostra idea di qualità, con la capacità di essere sempre vicini, pronti a trovare nuove soluzioni.

Logistics: punctual and reliable

The care of the product transported and the certainty of the delivery times are an expression of global quality and customer service. This is why all the logistics are managed internally by the company, by means of its own vehicles. Our company programs all aspects of transport/delivery to meet different needs, from the loading phase up to the final delivery to our customer, through a fleet of company vehicles of various sizes which cover the entire Italian territory weekly. All the vehicles are equipped with an advanced GPRS system for the immediate location of the trucks. Our after-sales service is also an expression of our idea of quality with the ability to always be close and ready to find new solutions.



Certificati per voi

Il Sistema Qualità di SEIPO - certificato UNI EN ISO 9001:2000 N°10395 - è conforme alle normative internazionali per l'assicurazione della qualità nella progettazione, sviluppo, fabbricazione e assistenza ai clienti. Il processo di industrializzazione altamente informatizzato è eseguito con le tecnologie di produzione più sofisticate. Dopo le fasi di ricerca e progettazione, i prodotti, elaborati grazie all'ausilio delle più recenti tecnologie, sono codificati e inseriti nel sistema informatico aziendale per consentire la programmazione della produzione e degli acquisti. Gli ordini dei clienti sono trasmessi in produzione entro 24 ore. SEIPO dedica particolare attenzione alle tematiche di protezione ambientale ed ha ottenuto la prestigiosa certificazione UNI EN ISO 14001:2004 N°10396; questo riconoscimento attesta che l'azienda soddisfa i criteri di valutazione per un efficace sistema di Gestione Ambientale per ciò che riguarda la progettazione, produzione, stoccaggio, spedizione e consegna di sedie e accessori per ufficio, nonché di mobili ed arredi. Inoltre, SEIPO è conforme alla normativa OHSAS 18001:2007 N° 21210, che rappresenta lo standard per la gestione della salute e della sicurezza dei lavoratori. L'insieme del rispetto delle tre norme citate ha consentito l'ottenimento del Riconoscimento di Eccellenza.

Certified for you

The Quality System of Seipo S.r.l. - certified UNI EN ISO 9001:2000 N°10395 - complies with the international standards for quality assurance in design, development, manufacturing and customer service. Our highly computerised industrialization process is implemented with the most sophisticated production technology. After the research and design phases, the products are processed by using the latest computer technology, they are codified and entered into the company's software system for production and purchasing programming. The customer's order is processed within 24 hours. Seipo S.r.l. dedicates particular attention to environmental protection thus achieving the prestigious UNI EN ISO 14001:2004 N°10396 certification. This recognition certifies that Seipo S.r.l. meets the assessment criteria for an effective Environmental Management system in regards to design, production, storage, shipment and delivery of office chairs and accessories, in addition to office furniture and furnishings. Seipo has obtained the ambitious achievement of being compliant to the OHSAS 18001:2007 N° 21210 standard. It represents the standard for the health and safety management of workers. Seipo Srl has achieved the Recognition of Excellence in respect to the whole of the three norms mentioned above.



STONE

Design: Giovanni Iurato

Desks
Meeting
Cabinet
Small tables
Receptions



La collezione STONE, sviluppata per SEIPO dal designer Giovanni Iurato, trae ispirazione dal mondo delle pietre. Il filo conduttore che lega tutti gli elementi della collezione è sia l'estetica che la funzionalità. La collezione costituita da elementi singoli che da soluzioni ad alta componibilità si integra perfettamente a tutta la produzione Seipo.

The STONE collection was developed by designer Giovanni Iurato for SEIPO, it draws inspiration from the world of stones. The common thread that links all the elements of the collection is both aesthetics and functionality. The collection consists of single elements and highly modular solutions which perfectly integrate with the entire Seipo production.





Ambiente realizzato con scrivanie COBBLE. Librerie RIVER. Sedute COVER

Environment created with COBBLE desks. RIVER bookcases. COVER seatings

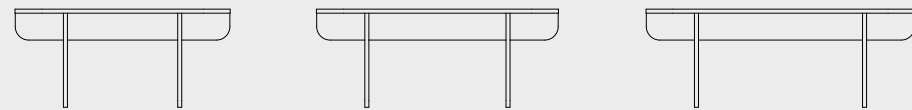
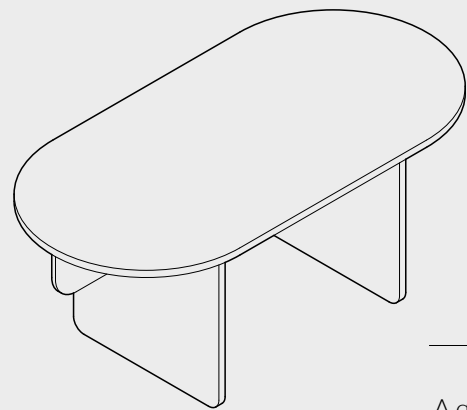

COBBLE è una serie di elementi il cui design ricorda la forma di un ciottolo levigato. A questa serie appartengono due scrivanie di diversa misura, un tavolo per le riunioni ed un tavolino per le sale d'attesa.

COBBLE is a series of elements whose design resembles the shape of a polished pebble. This series includes two desks in different sizes, a table for meetings and a coffee table for waiting rooms.

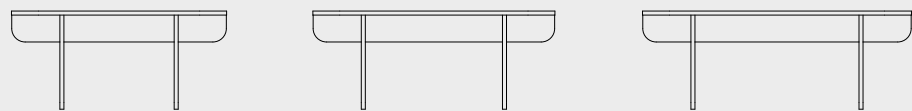
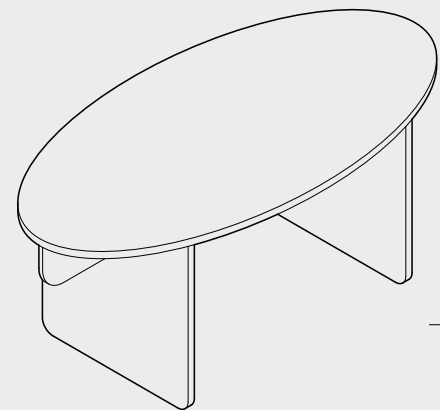

OBSIDIAN è una serie di tavoli in materiale melaminico, la cui forma trae ispirazione dall'ossidiana. Tale serie è costituita da un tavolino per le sale d'attesa, un tavolo riunioni e due scrivanie.

OBSIDIAN is a series of tables in melamine material, whose form is inspired by obsidian. This series consists of a table for waiting rooms, a meeting table and two desks.

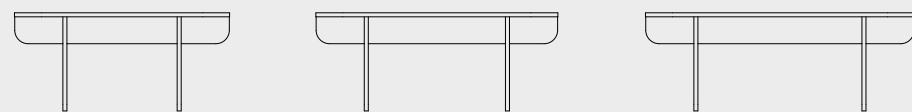
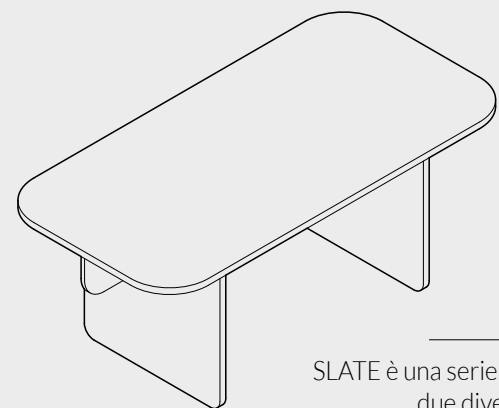

SLATE è una serie di tavoli la cui forma ricorda quella delle lastre sottili di ardesia. La serie si articola attraverso due diverse scrivanie, un tavolino per le sale d'attesa ed un tavolo più grande adatto alle sale riunioni.

SLATE is a series of tables whose shape resembles that of thin slate slabs. The series consists of two different desks, a small table for waiting rooms and a larger table suitable for meeting rooms.



MARBLE è una serie di cassettiere di diversa misura alla quale appartengono le versioni MEDIUM e TALL, rispettivamente da tre e quattro cassetti. Il design si ispira ad un blocchetto di marmo e ben si abbina alla serie di tavoli e scrivanie COBBLE, formando un set completo. La cassettiera MARBLE tuttavia sa adattarsi bene ad ogni contesto, soprattutto se collocata in ambienti contract.

MARBLE is a series of drawers of different sizes to which the MEDIUM and TALL versions belong, respectively with three and four drawers. The design is inspired to a marble block and goes well with the COBBLE series tables and desks, forming a complete set. The MARBLE chest of drawers, however, adapts well to any context, especially if placed in contract environments.

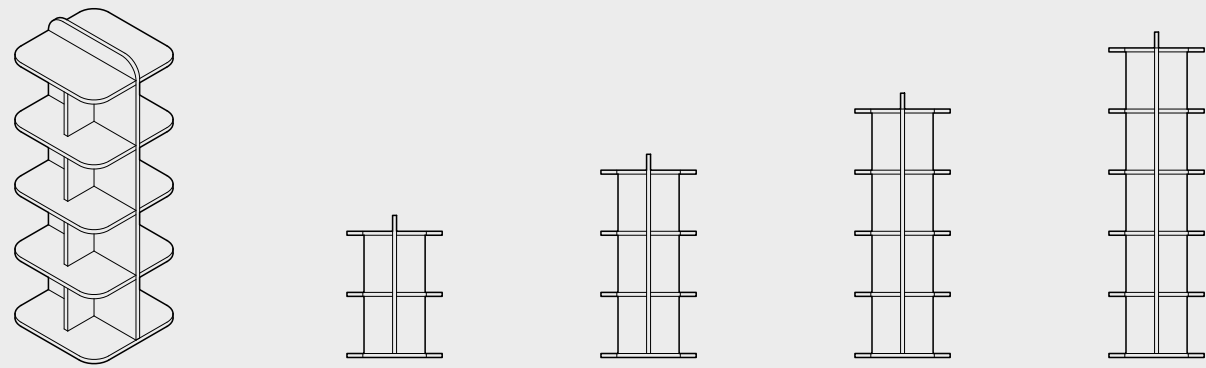

BALANCE è una serie di librerie la cui forma si ispira a delle pietre in equilibrio. BALANCE ha un design a tutto tondo che consente di usarla da tutti i lati e per cui la si può porre anche al centro di una stanza. In oltre le si possono affiancare più elementi per aumentare la capienza.

BALANCE is a series of bookcases whose shape is inspired by balanced stones. BALANCE has an all-round design which allows for it to be used on all sides and can also be placed in the center of a room. In addition, more elements can be added to increase its capacity.



RIVER è una serie di librerie nelle versioni MEDIUM e TALL entrambe in moduli da 40 e 80 cm. La sua capienza può crescere affianandone più esemplari o modulandola. La sua conformazione la rende adatta ad essere posta anche a centro stanza.

RIVER is a series of bookcases with MEDIUM and TALL versions, both in 40 and 80 cm modules. Its capacity can increase by adding to it or by modulating it. Its structure makes it suitable to be placed in the center of a room or against a wall.

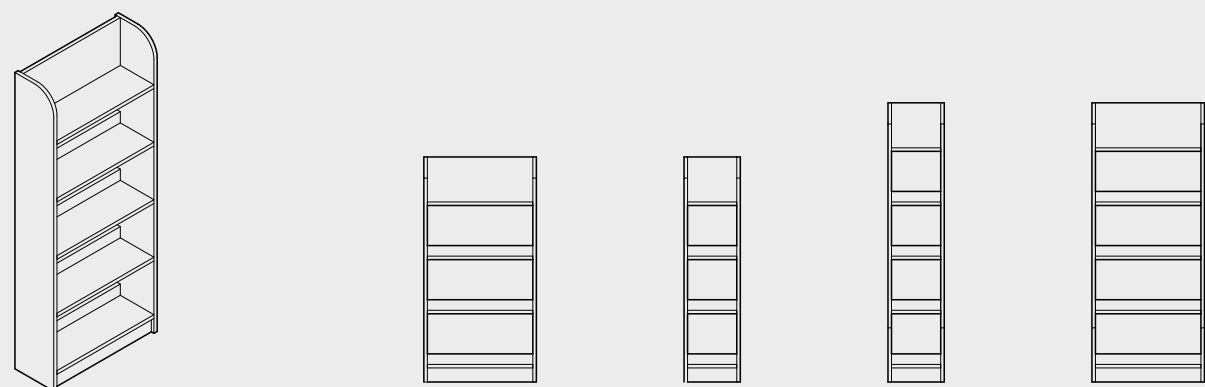

ONYX è una serie di librerie che prevede dimensioni da 40 e da 80 cm nelle versioni MEDIUM e TALL. ONYX è idonea ad essere disposta a schiena contrapposta a centro stanza o appoggiata ad una parete.

ONYX is a series of bookcases with 40 and 80 cm dimensions in MEDIUM and TALL versions. ONYX is suitable to be placed opposite the center of a room or leaning against a wall.

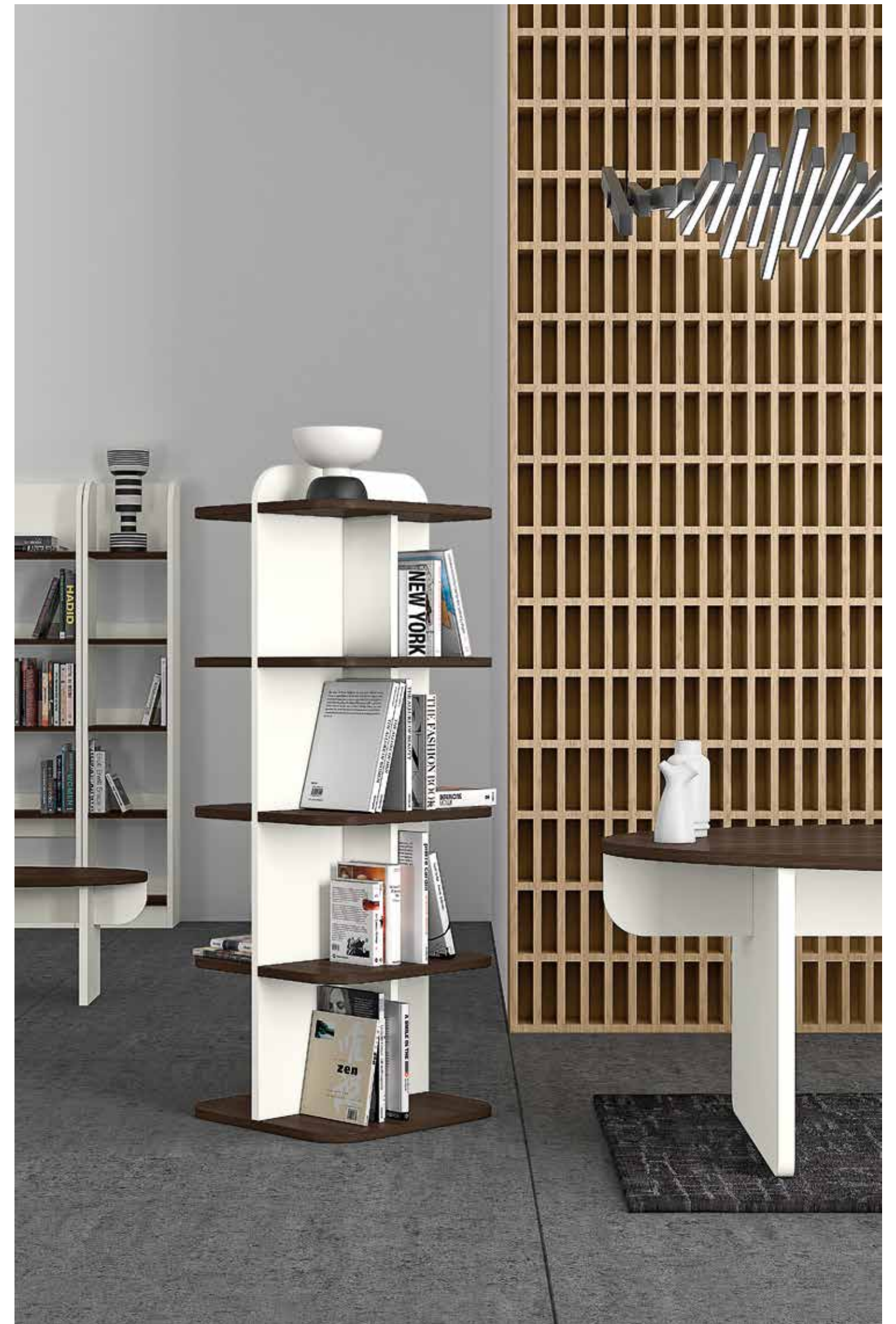



Ambiente realizzato con scrivanie e tavoli riunione COBBLE. Librerie RIVER, Pouff CUBE e panca SMOOTH.
La seduta è della serie COVER.

This environment is created with COBBLE desks and meeting tables. RIVER bookcases, CUBE ottomans and SMOOTH benches. The seating is from the COVER model chairs.

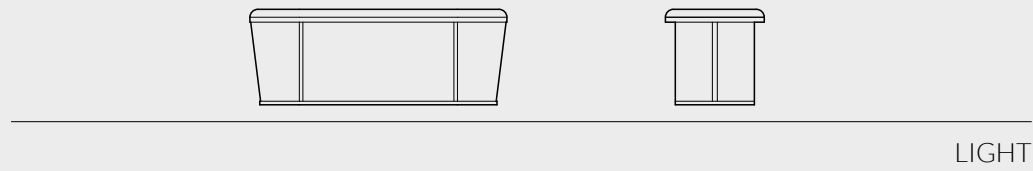
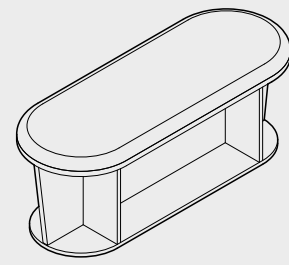

LIGHT

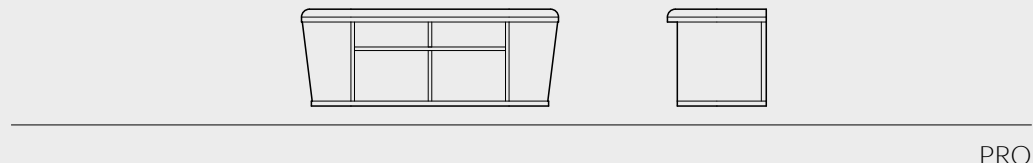
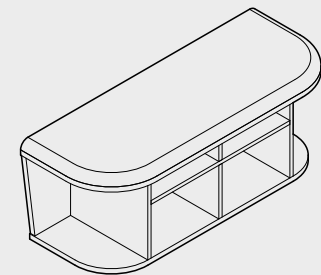

PRO

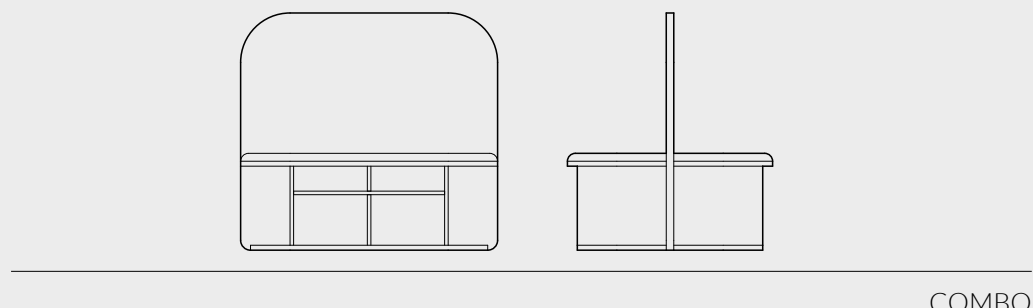
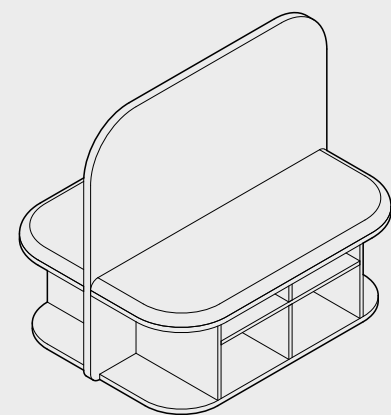

COMBO

SMOOTH è una serie di panchette la cui forma ricorda le pietre lisce. Essa conta tre versioni: LIGHT, PRO e COMBO. La prima è priva di vani porta oggetti ed è idonea ad essere messa al centro di una stanza, la seconda la si può collocare adiacente ad una parete ed è provvista di vani mentre la terza è una soluzione componibile che prevede l'eventuale uso di una parete divisoria.

SMOOTH is a series of benches whose shape resembles smooth stones, it has three versions: LIGHT, PRO and COMBO. The LIGHT version has no storage compartments, it is suitable to be placed in the middle of a room, the PRO version can be placed adjacent to a wall and is provided with compartments while the COMBO version is a modular solution which can also be used as a wall divider.





CUBE è una serie di sedute costituita dai pouf BLOCK, CAPITAL e BRICK che, con le loro forme, ricordano rispettivamente un blocco di pietra, un capitello ed un mattoncino. Le tre versioni sono realizzate in materiale melaminico e sono munite di vano portaoggetti, al quale si accede sollevando la seduta dotata di apposita cerniera. La serie CUBE è adatta ad ogni contesto.

CUBE is a series of seats consisting of the BLOCK, CAPITAL and BRICK poufs. Their shapes respectively recall a block of stone, a capital and a brick. The three versions are made of melamine material and have a storage compartment which can be accessed by lifting the seat which is equipped with a special hinge. The CUBE series is suitable for any context.



PEBBLE, la cui forma ricorda un sassolino, è un versatile tavolino che incorpora, in maniera innovativa, una soluzione porta riviste.

PEBBLE, whose shape resembles a pebble is a versatile table which incorporates an innovative magazine rack.



MILESTONE è un simpatico e pratico portariviste, realizzato in materiale melaminico e dotato di una comoda maniglia. Esso è adatto a vari tipi di contesto.

MILESTONE is a nice and practical magazine rack made of melamine material and equipped with a comfortable handle. It is suitable for various types of contexts.

STONE

Design: Giovanni Iurato

Desks
Meeting
Cabinet
Small tables
Receptions



I tavoli riunione della collezione STONE, si integrano perfettamente a tutti gli ambienti esistenti, anche con linee di prodotto diverse.

The STONE meeting tables collection integrate perfectly with all existing environments, even with different product lines.





Ambiente casa con l'inserimento di un'area ufficio. Scrivania SLATE e libreria RIVER. Seduta COVER.

Home environment with the insertion of an office area. SLATE desk and a RIVER bookcase. COVER model chairs.

STONE

Design: Giovanni Iurato

- Desks
- Meeting
- Cabinet
- Small tables**
- Receptions

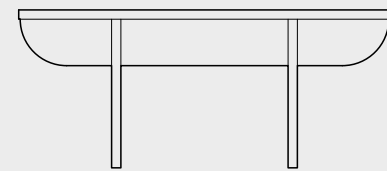
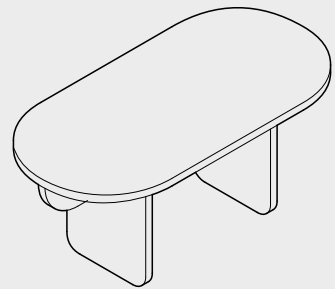

Tavolo/Table COBBLE

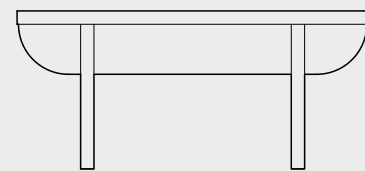
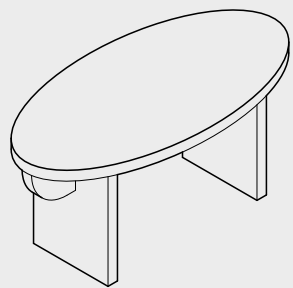

Tavolo/Table OBSIDIAN

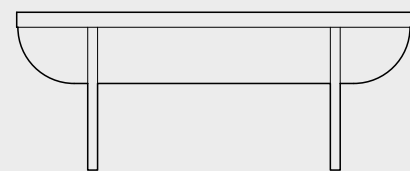
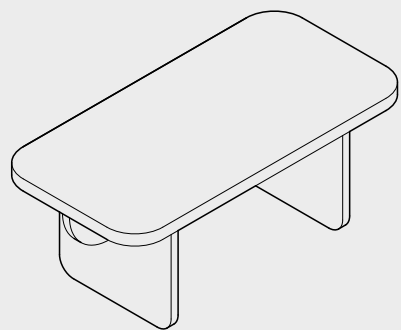

Tavolo/Table SLATE

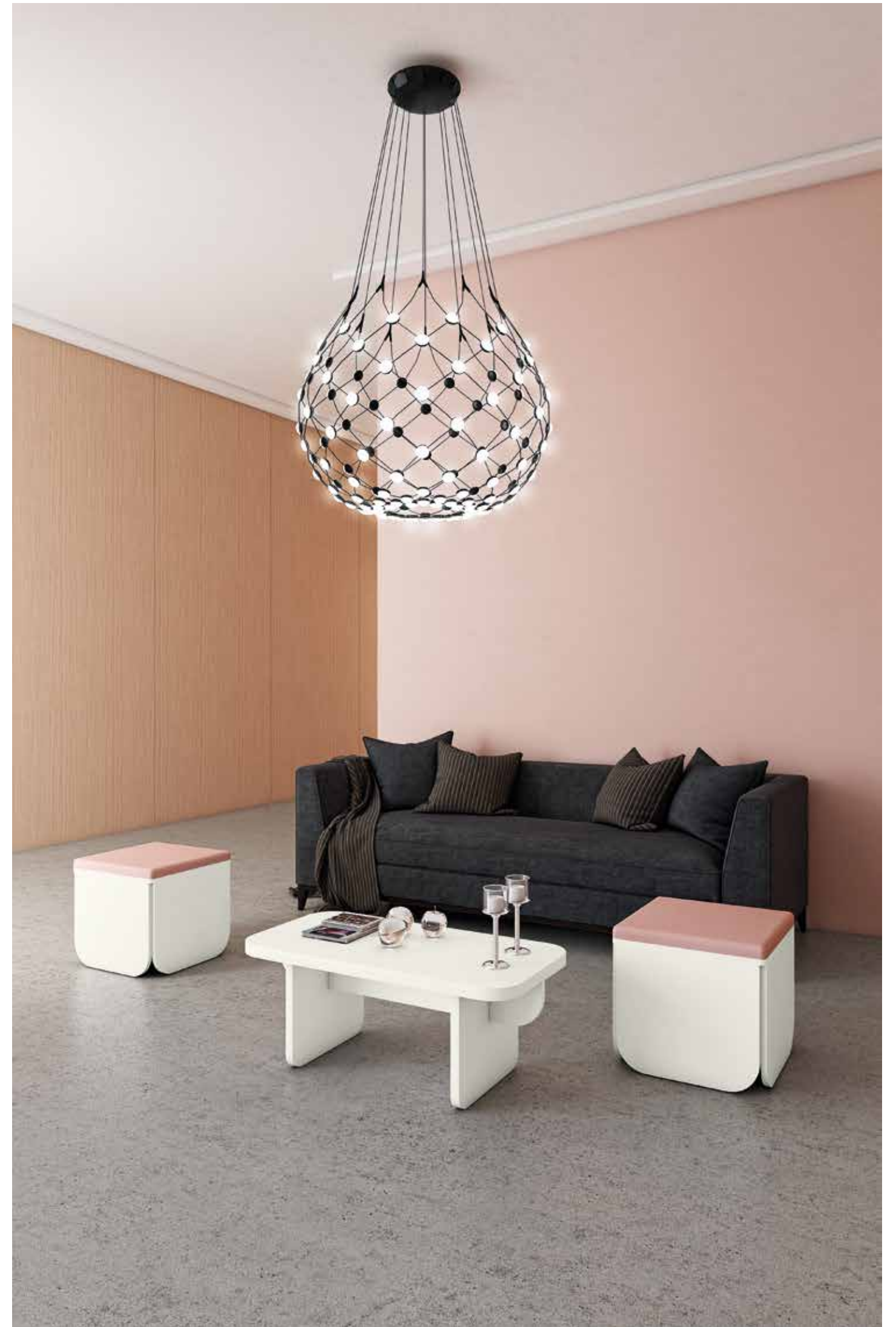

STONE

Design: Giovanni Iurato

Desks
Meeting
Cabinet
Small tables
Receptions



SEASTONE è un mobile reception la cui forma dei pannelli laterali richiama quella delle pietre di mare, presenti su molte spiagge. La serie conta tre moduli standard da 80, 100 e 120 cm. più moduli angolari destri ed sinistri, interni ed esterni. Le combinazioni sono molteplici grazie a tutti gli elementi che permettono configurazioni per tutte le esigenze di spazio e di funzionalità.

SEASTONE is a reception, the shape of its side panels recall that of sea stones, present on many beaches. The series has three standard modules of 80, 100 and 120 cm. plus right and left, internal and external corner modules. The combinations are many thanks to all the elements which allow configurations for all space and functionality requirements.





Composizione reception SEASTONE con mobili cassettiere, a giorno o con ante. Seduta modello COVER, Divano modello AGREE.

SEASTONE reception composition with chest of drawers, at sight or with doors. COVER model chairs and AGREE model couches.



Composizione reception SEASTONE con possibilità di inserimento led sotto mensola per illuminazione di eventuale logo aziendale.

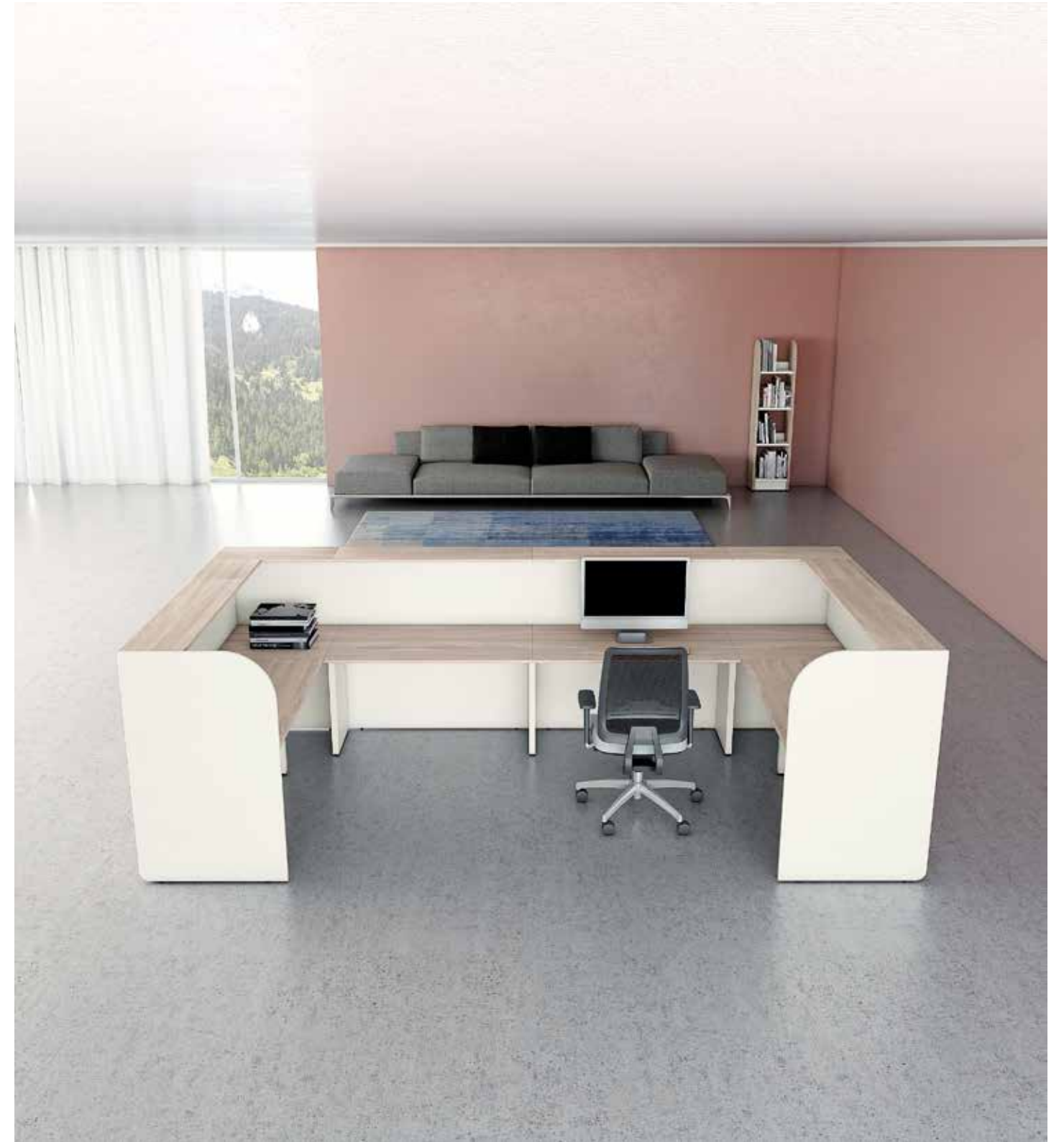

SEASTONE reception composition with the possibility of inserting led lighting under the shelf for an company logo.

STONE

Design: Giovanni Iurato

- Desks
- Meeting
- Cabinet
- Small tables
- Receptions**

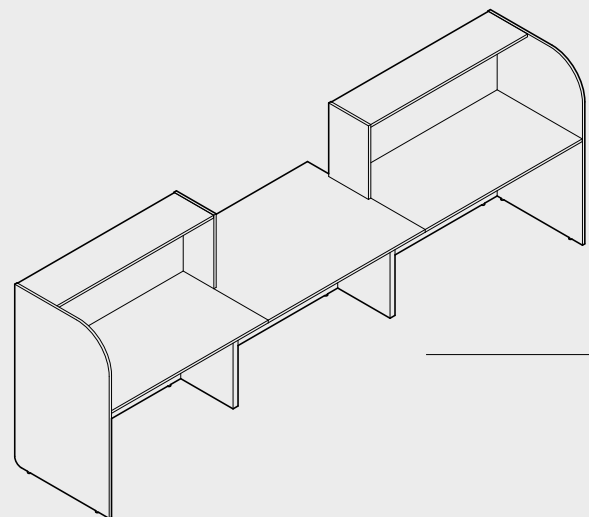

Configurazione bancone reception con scrivania intermedia
Reception counter configuration with intermediate desk

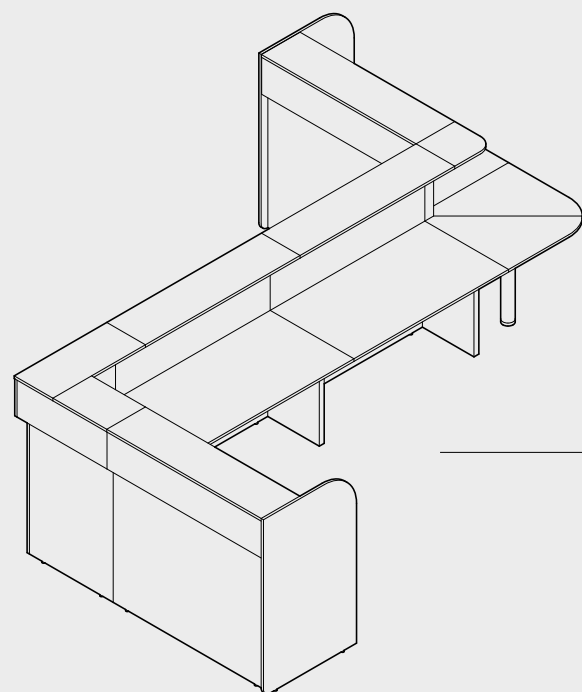

Configurazione bancone reception con angolo interno ed esterno
Reception counter configuration with internal and external corner

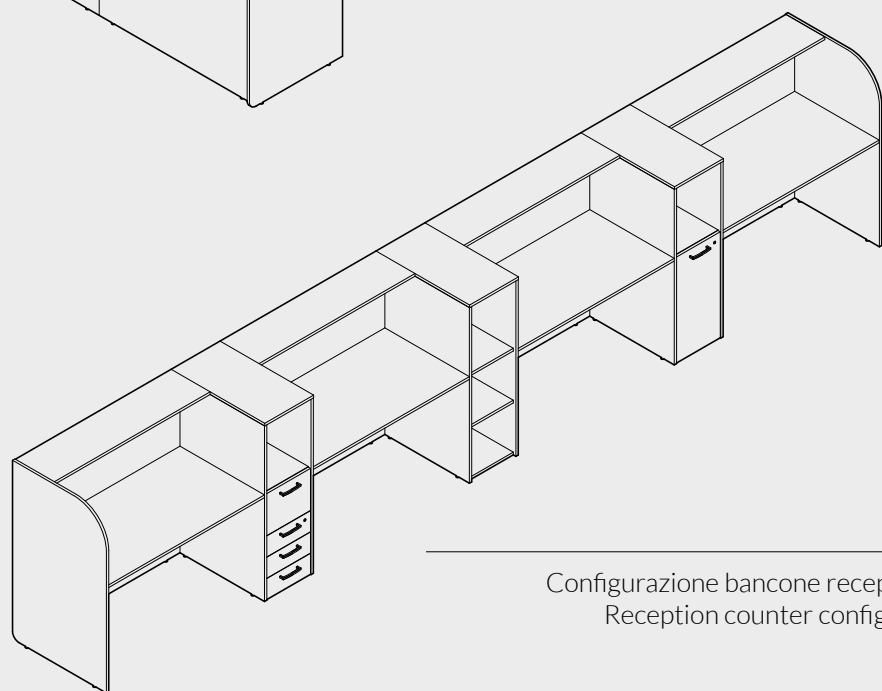

Configurazione bancone reception con mobili contenitori e cassettiere condivise
Reception counter configuration with shared cabinets and chest of drawers

COLORE COLOUR



NC
Noce chiaro
Light walnut



NS
Noce scuro
Dark walnut



OC
Olmo chiaro
Light elm

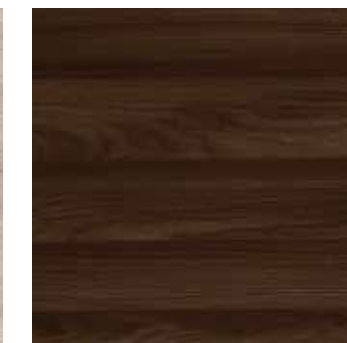

OS
Olmo scuro
Dark elm



RC
Rovere chiaro
Light durmast



RT
Rovere tabacco
Durmast tobacco



BI
Bianco
White

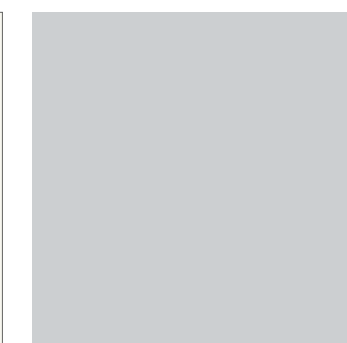

GR
Grigio
Grey



NR
Nero
Black

MANIGLIE
HANDLES



MP01.BI
Maniglia in plastica bianca
White plastic handle



MP01.GR
Maniglia in plastica grigia
Grey plastic handle



MZ02.AN
Maniglia in zamac antracite
Anthracite zinc alloy handle



MZ02.GR
Maniglia in zamac grigia
Grey zinc alloy handle



MZ01.GR
Maniglia in zamac grigia
Grey zinc alloy handle



MZ01.BI
Maniglia in zamac bianca
White zinc alloy handle



MA01.SA
Maniglia in alluminio satinato
Satin aluminium handle

SPESSORE PIANI
TOPS THICKNESS



Piani scrivanie
Desk tops
Piani spessore 30 mm
Top thickness 30 mm



Piani tavoli riunione
Meeting table tops
Piani spessore 30 mm
Top thickness 30 mm



Piani reception
Reception tops
Piano di lavoro spessore 25 mm,
mensola spessore 18 mm
Work top 25 mm thickness, shelf 18
mm thickness



Portariviste
Magazine rack
Spessore 18 mm
Thickness 18 mm

ELETTRIFICAZIONE
ELECTRIFICATION

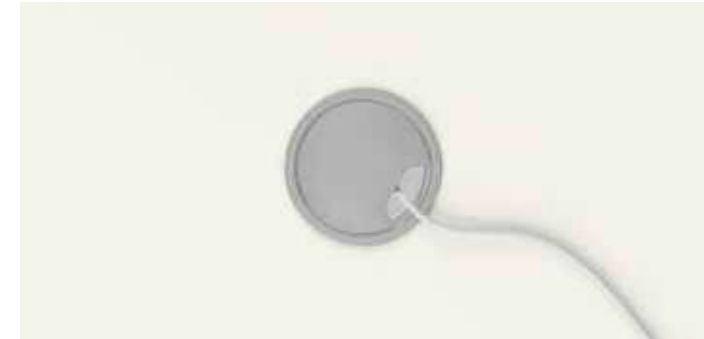

Tappo passacavi
Cable duct cap

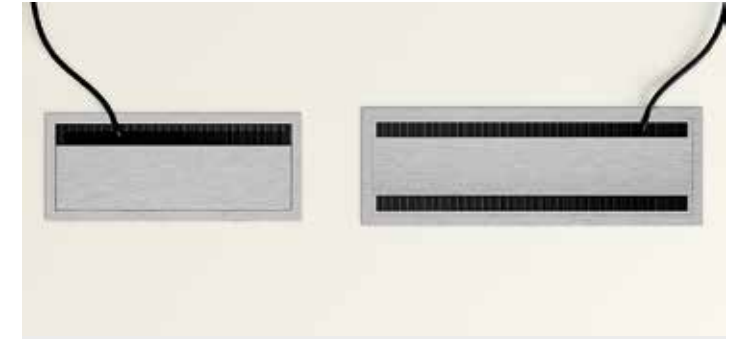

Flap passacavi con apertura singola o doppia
Cable duct flap with single or double opening



Flap con frutti power, dati e USB recharge
Flap with hidden jack, data and USB recharge



Torretta con frutti power, dati e USB recharge
Extractable turret jack, data and USB recharge



Canalina passa cavi orizzontale e
verticale
Horizontal and vertical cable duct





Vertebra verticale
Vertical vertebra cable management





Porta PC sospeso e su ruote
Suspended PC case and on wheels

STONE SYSTEM



SCRIVANIE, TAVOLI RIUNIONE E TAVOLI BASSI / DESKS, MEETING TABLES AND LOW TABLES

COBLE - OBSIDIAN - SLATE	Desk		LUNGHEZZE/LENGTHS 180-200 - PROFONDITÀ/DEPTH 90 - ALTEZZA/HEIGHT 73
	Meeting		LUNGHEZZE/LENGTHS 220-240 - PROFONDITÀ/DEPTH 90 - ALTEZZA/HEIGHT 73 LUNGHEZZE/LENGTHS 220-240 - PROFONDITÀ/DEPTH 120 - ALTEZZA/HEIGHT 73
	Low table		LUNGHEZZE/LENGTHS 100 - PROFONDITÀ/DEPTH 50 - ALTEZZA/HEIGHT 40

CASSETTIERE / CHEST OF DRAWERS



MARBLE		3 CASSETTI/DRAWERS		4 CASSETTI/DRAWERS
--------	---	--------------------	---	--------------------

LIBRERIE / BOOKCASES

BALANCE		LUNGHEZZA/LENGTH 60 - PROFONDITÀ/DEPTH 90 - ALTEZZE/HEIGHTS 89,5-128-166,5-205
RIVER		LUNGHEZZA/LENGTH 40 - PROFONDITÀ/DEPTH 30 - ALTEZZE/HEIGHTS 160-198 LUNGHEZZA/LENGTH 80 - PROFONDITÀ/DEPTH 30 - ALTEZZE/HEIGHTS 160-198
ONYX		LUNGHEZZA/LENGTH 40 - PROFONDITÀ/DEPTH 30 - ALTEZZE/HEIGHTS 160-198 LUNGHEZZA/LENGTH 80 - PROFONDITÀ/DEPTH 30 - ALTEZZE/HEIGHTS 160-198

STONE SYSTEM

RECEPTION / RECEPTION

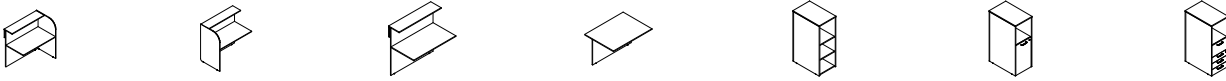
SEASTONE		LUNGHEZZE/LENGTHS 80-100-120 - PROFONDITÀ/DEPTH 72 - ALTEZZA/HEIGHT 112
		LUNGHEZZE/LENGTHS 80-100-120 - PROFONDITÀ/DEPTH 72 - ALTEZZA/HEIGHT 112
		LUNGHEZZE/LENGTHS 80-100-120 - PROFONDITÀ/DEPTH 72 - ALTEZZA/HEIGHT 112

PANCHE E POUF / BENCHES AND FOOTSTOOLS

SMOOTH		LUNGHEZZE/LENGTHS 130 - PROFONDITÀ/DEPTH 50 - ALTEZZA/HEIGHT 45
--------	---	---

CUBE

	LUNGHEZZE/LENGTHS 45 - PROFONDITÀ/DEPTH 45 - ALTEZZA/HEIGHT 45
---	--

PORTARIVISTE / MAGAZINE RACK

PEBBLE MILLESTONE		LUNGHEZZA/LENGTH 80 - PROFONDITÀ/DEPTH 50 - ALTEZZA/HEIGHT 45		LUNGHEZZA/LENGTH 40 - PROFONDITÀ/DEPTH 15,6 - ALTEZZA/HEIGHT 40
-------------------	---	---	---	---

ROYAL

Desk
Meeting
Cabinet & drawers
Cube



ROYAL è una linea di scrivanie direzionali con piani e fianchi da spessore mm 38. La struttura pannellata o metallica in due colori e la molteplicità di forme e misure, ne consentono una ottima flessibilità nella configurazione di diversi contesti. Poltrone modello Leather.

ROYAL is a line of executive desks with 38 mm thick tops and sides, the panelled or metal structure in two colors and the multiplicity of shapes and sizes allow for excellent flexibility for configuration of different contexts. Leather model chairs.



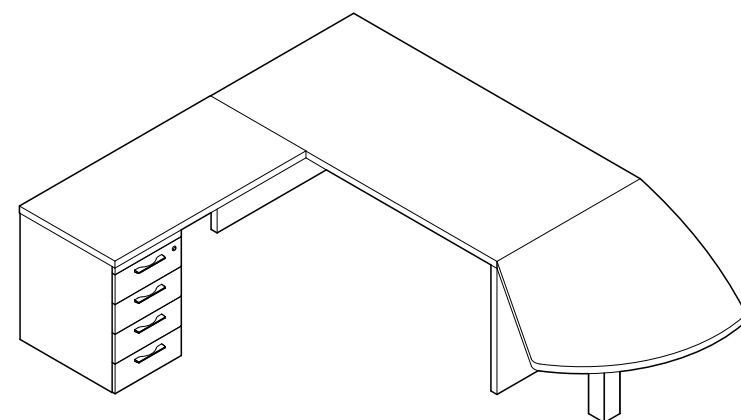

Tavoli riunione e scrivanie ROYAL. Poltrone Modello LEATHER.

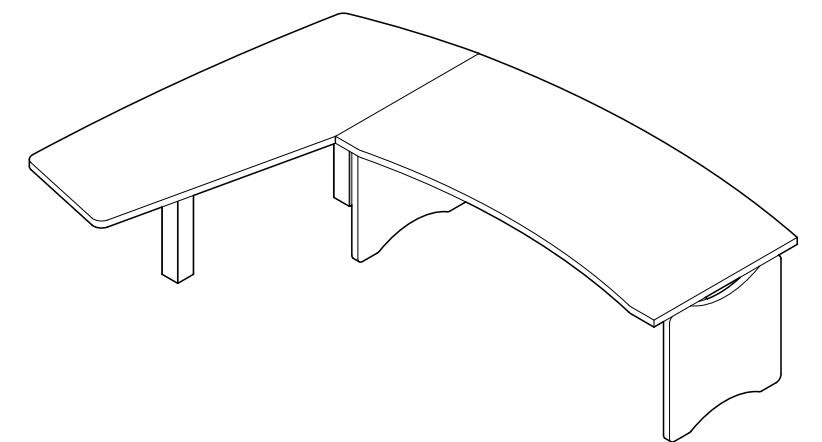

ROYAL meeting tables and desks. LEATHER model armchairs.

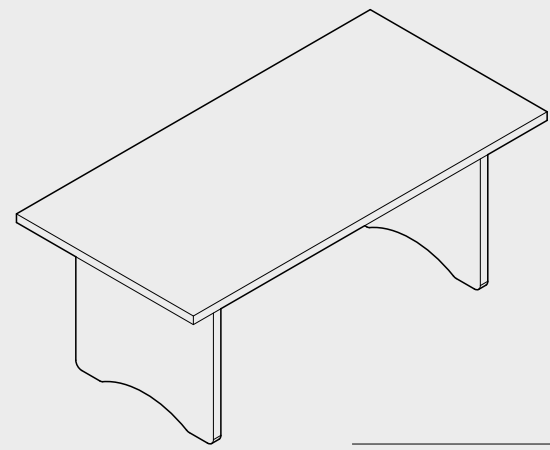

Piano retto
Straight top

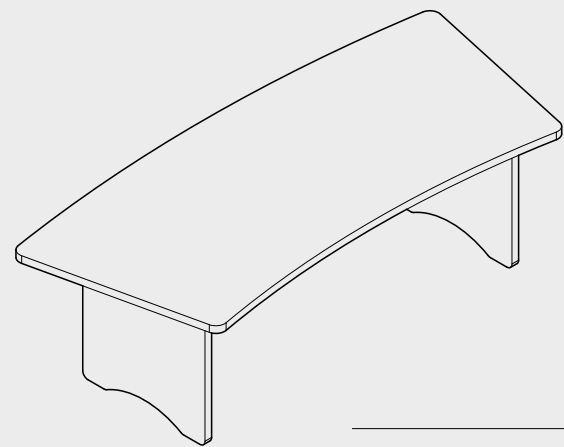

Piano sagomato Royal Elite
Royal Elite contoured top

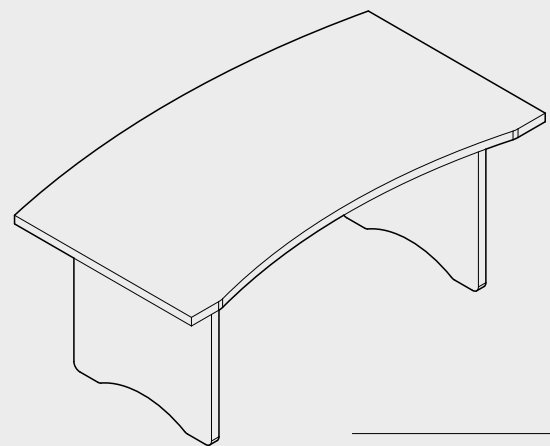

Piano sagomato lato operatore e visitatore
Contoured top for operator and visitor sides

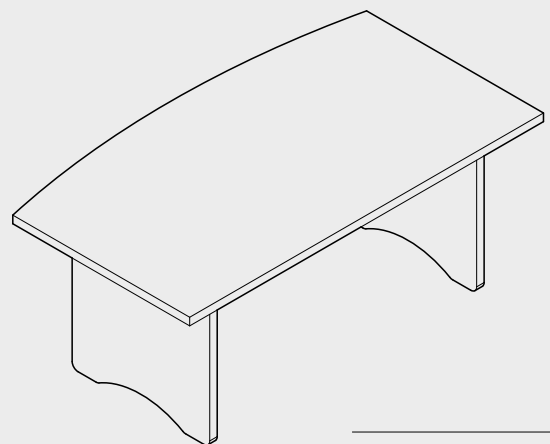

Piano sagomato lato visitatore
Visitor side contoured top



Scrivania piano e fianchi sagomate con appendice e cassettiera. Poltrone modello LEATHER.
Desk with contoured top and sides with return desk and chest of drawers. LEATHER model chairs.



Cassettiera 3 cassetti.
Chest of drawers with 3 drawers.



Mobile di servizio.
Service unit.



Scrivania piano vetro, struttura metallica e mobile di servizio. Poltrone modello PRIMA.
 Glass desk top with metal structure and service unit. PRIMA model managerial chairs.

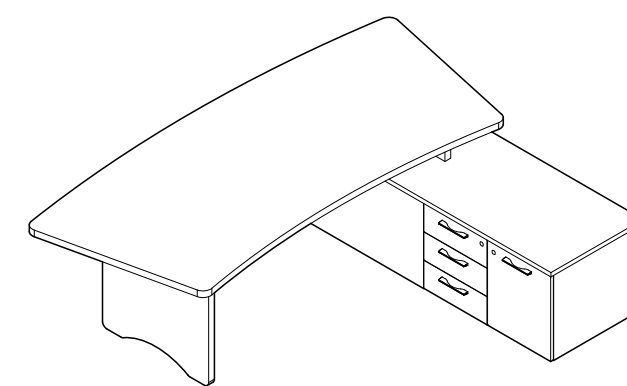
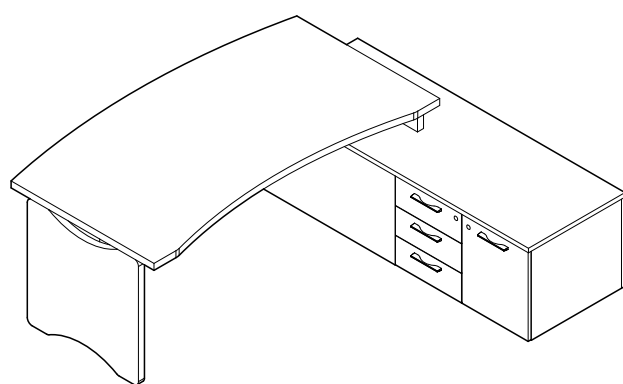



ROYAL

Desk
Meeting
 Cabinet & drawers
 Cube



Tavolo riunione con basi a colonna zavorrate. Poltrone modello LEATHER.
 Meeting table with ballast bases and columns. LEATHER model chairs.



Tavolo riunione con struttura metallica. Poltrone modello LEATHER.
 Meeting table with metal structure. LEATHER model chairs.



Sagoma tavolo riunione.
 Contoured meeting table.



Tavolo riunione pannellato composto. Armadiatura ROYAL cabinet. Poltrone modello ALUMINIUM.
Composed panelled meeting table, ROYAL cabinet cupboard. ALUMINIUM model armchairs.

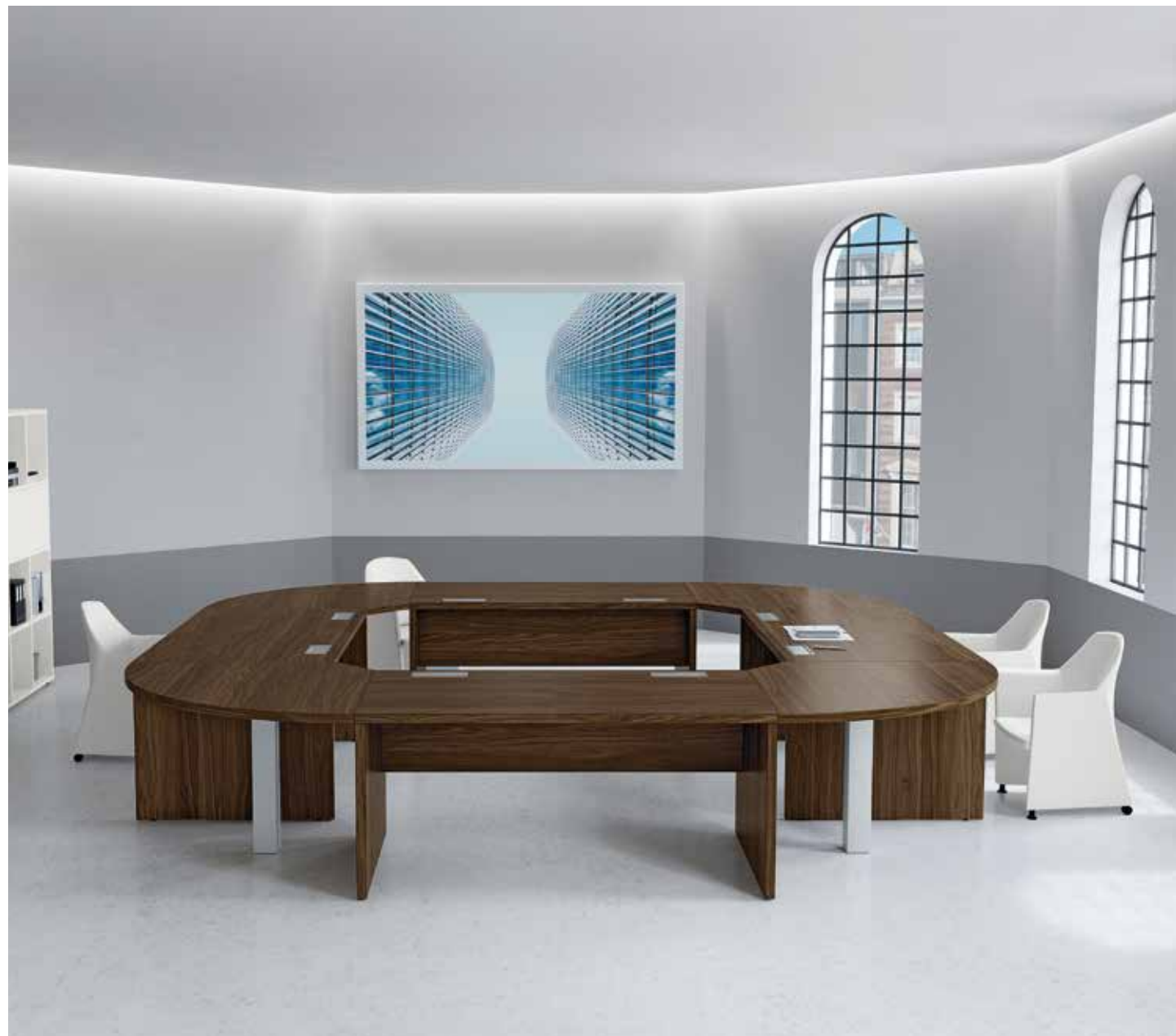

Tappo passacavi.
Cable duct cap.

Flap passacavi con apertura singola o doppia.
Cable duct flap with single or double opening.



Flap con frutti power, dati e USB recharge.
Flap with hidden jack, data and USB recharge.



Torretta con frutti power, dati e USB recharge.
Extractable turret jack, data and USB recharge.

ROYAL SYSTEM DESK

SCRIVANIE P. 90 FIANCHI QUADRATI / DESKS D. 90 SQUARED SIDES

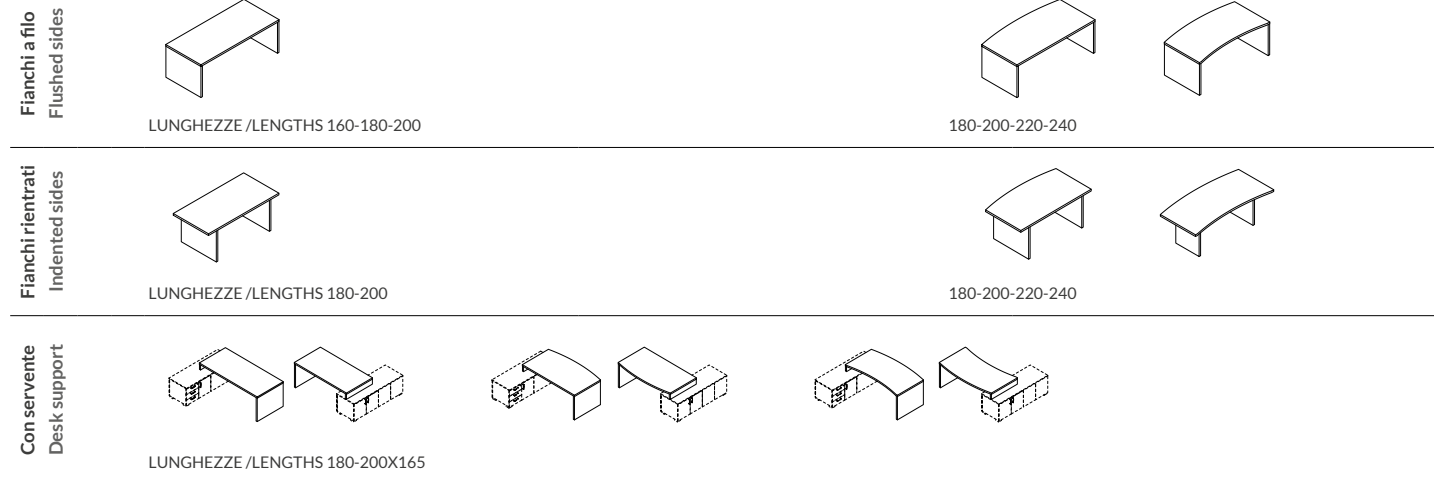

SCRIVANIE P. 90 FIANCHI SAGOMATI / CONTOURED AL POSTO DI SHAPED

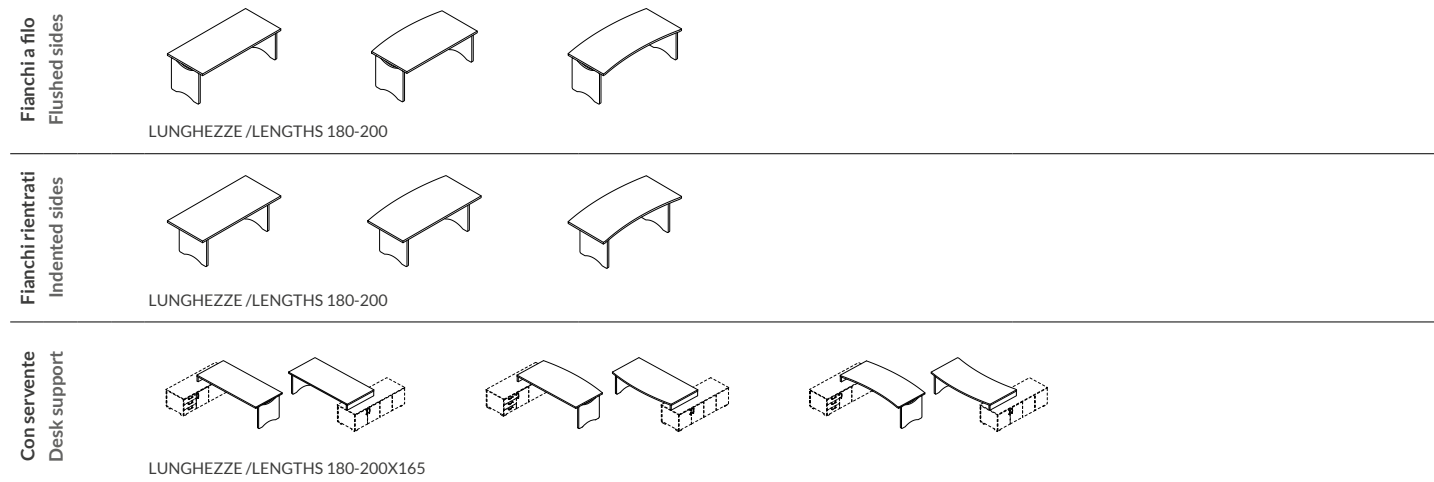

SCRIVANIE P. 90 GAMBE METALLICHE / DESKS D. 90 METAL LEGS

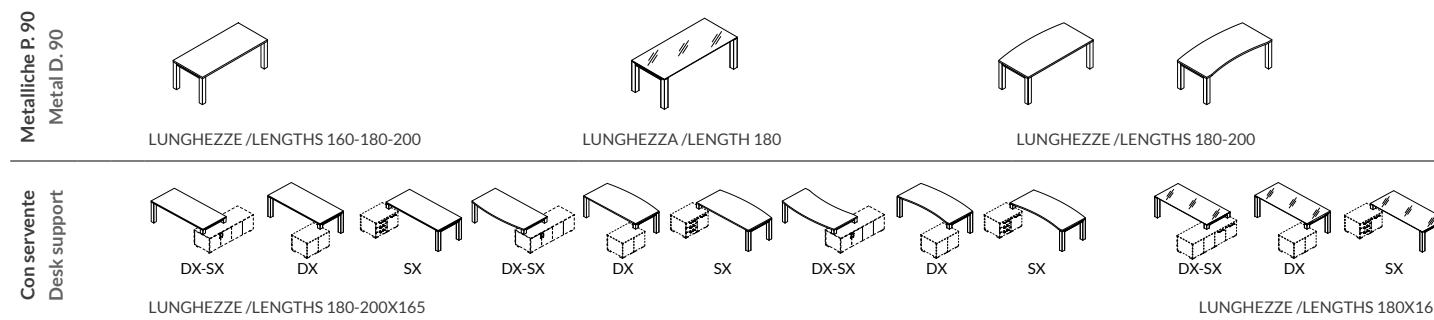

ALLUNGHI / EXTENSION

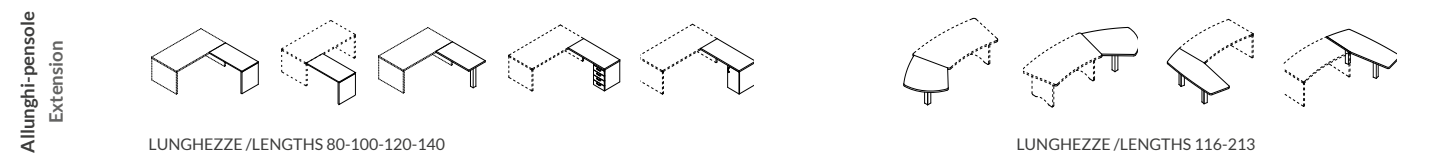

SCRIVANIE ELITE / ELITE DESKS



ROYAL SYSTEM DESK

MODESTY / MODESTY



ELEMENTI SERVENTE / SUPPORT UNIT ELEMENTS

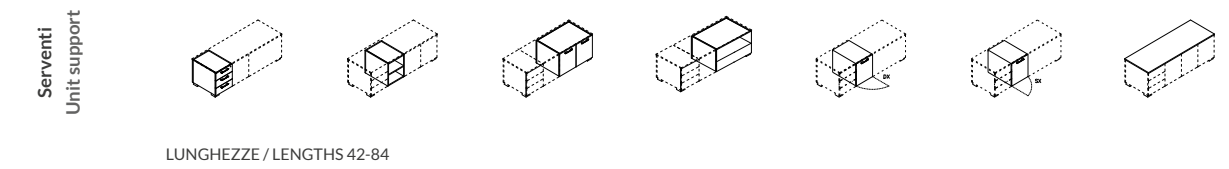

ROYAL SYSTEM MEETING

TAVOLI RIUNIONE / MEETING TABLES

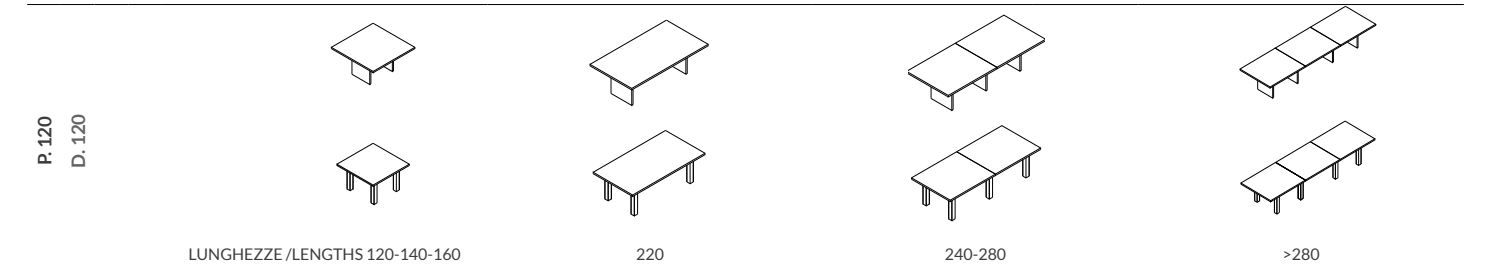

TAVOLI RIUNIONE OVALI / OVAL MEETING TABLES

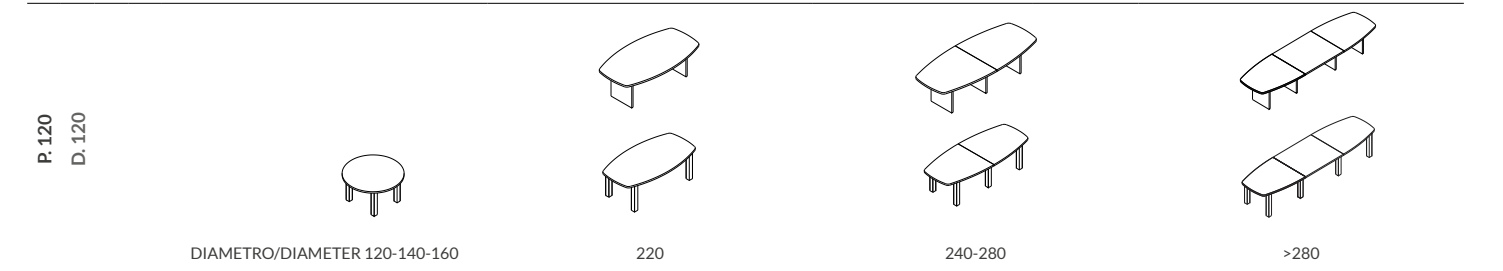

TAVOLI RIUNIONE CON GAMBE TONDE / MEETING TABLES WITH ROUND LEGS



ROYAL

Desk
Meeting
Cabinet & drawers
Cube





Contenitori ROYAL con fianchi condivisi.
ROYAL cabinets with shared sides.



Anta in melaminico.
Melamine door.



Anta in vetro con cornice alluminio.
Glass door with aluminium frame.



Anta fonoassorbente rivestita in tessuto.
Sound absorbing fabric door.



Anta in melaminico sagomato.
Contoured melamine door.

COLORE
COLOUR



NC
Noce chiaro
Light walnut



NS
Noce scuro
Dark walnut



OC
Olmo chiaro
Light elm



OS
Olmo scuro
Dark elm



RC
Rovere chiaro
Light durmast



RT
Rovere tabacco
Durmast tobacco

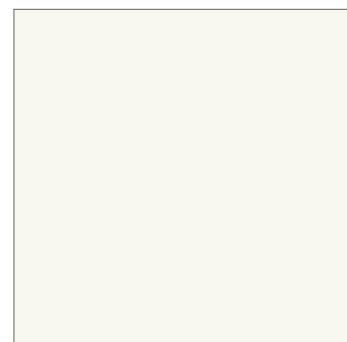

BI
Bianco
White

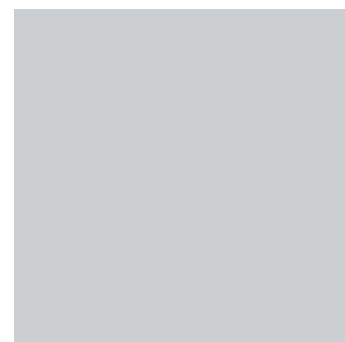

GR
Grigio
Grey

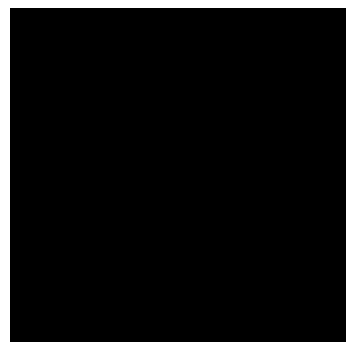

NR
Nero
Black

COLORE STRUTTURA
STRUCTURE COLOUR



GR
Grigio
Grey



AN
Antracite
Anthracite

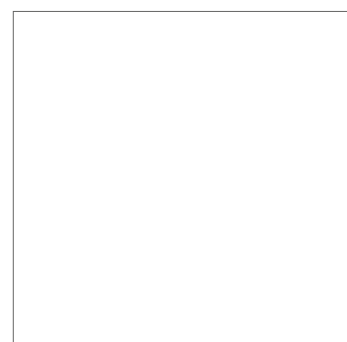

BI
Vetro bianco retro laccato
White glass lacquered back



NR
Vetro nero retro laccato
Black glass lacquered back

SPESORE PIANI
TOPS THICKNESS



38
Piani spessore 38 mm
Top thickness 38 mm

TIPOLOGIA GAMBE
TYPES OF LEGS



Fianco pannellato
Panelled side



Fianco pannellato sagomato
Contoured panelled side



Struttura metallica antracite Ral 7016
Metal structure anthracite Ral 7016



Struttura metallica grigia Ral 9006
Metal structure grey Ral 9006

TESSUTI PER ELEMENTI FONOASSORBENTI FABRICS FOR SOUND ABSORBING ELEMENTS

Trevira C.S. 100% Poliestere ignifugo
Trevira C.S. 100% Polyester fire retardant

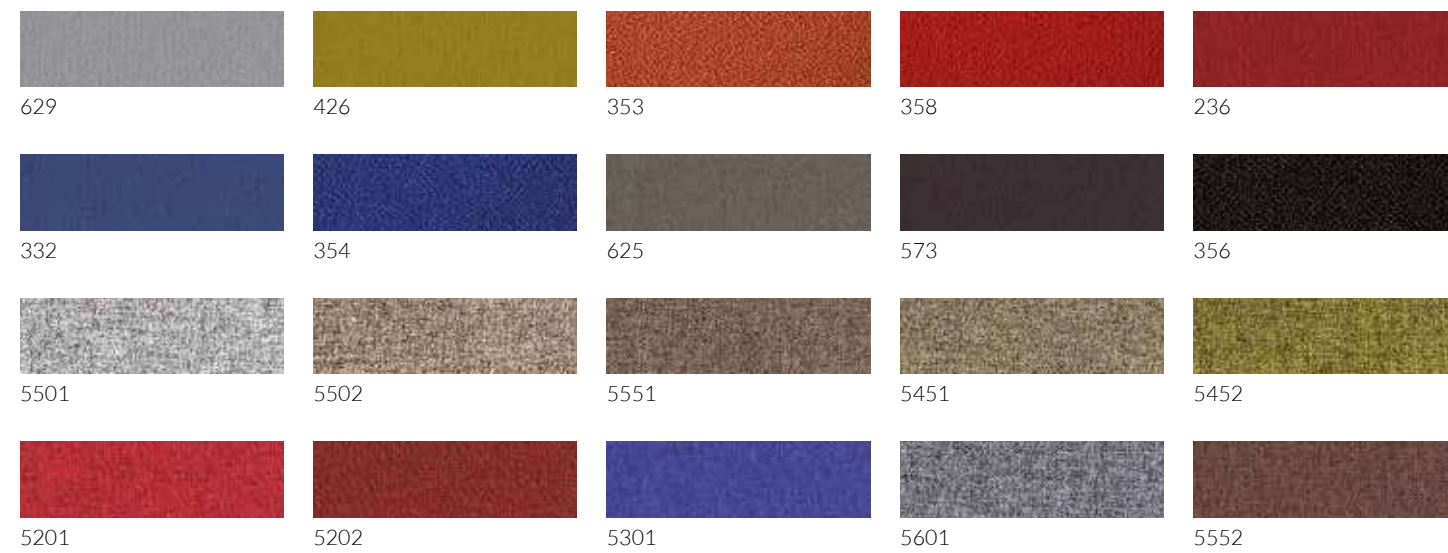

ELETTRIFICAZIONE ELECTRIFICATION



Tappo passacavi
Cable duct cap



Flap passacavi con apertura singola o doppia
Cable duct flap with single or double opening



Flap con frutti power, dati e USB recharge
Flap with hidden jack, data and USB recharge



Torretta con frutti power, dati e USB recharge
Extractable turret jack, data and USB recharge

MANIGLIE HANDLES



MP01.BI
Maniglia in plastica bianca
White plastic handle



MP01.GR
Maniglia in plastica grigia
Grey plastic handle



MZ02.AN
Maniglia in zamac antracite
Anthracite zinc alloy handle



MZ02.GR
Maniglia in zamac grigia
Grey zinc alloy handle



MZ01.GR
Maniglia in zamac grigia
Grey zinc alloy handle



MZ01.BI
Maniglia in zamac bianca
White zinc alloy handle



MA01.SA
Maniglia in alluminio satinato
Satin aluminium handle



Canalina passa cavi orizzontale e verticale
Horizontal and vertical cable duct



Vertebra verticale
Vertical vertebra cable management



Porta PC sospeso e su ruote
Suspended PC case and on wheels

RING

Desks
Benches
Meeting



Ring è una linea di scrivanie direzionali ed operative allo stesso tempo, con piani spessore mm 18-25-30. Disponibile anche il piano in vetro bianco e nero retro laccato. La struttura metallica in due colori e le varie forme e misure, ne consentono una ottima flessibilità nella configurazione in diversi contesti. Poltrone modello Tela.

Ring is a line of both executive and operative desks with 18-25-30 mm thick tops. It is also available with a black or white glass top and lacquered back. A metal structure in two colors and in various shapes and sizes allow for an excellent flexibility for different configured contexts. Tela model armchairs.





Scrivanie RING con cassetiera complanare. Contenitoro CABINET CUBE. Poltrone modello TELA.

RING desks with coplanar chest of drawers. CABINET CUBE. TELA model chairs

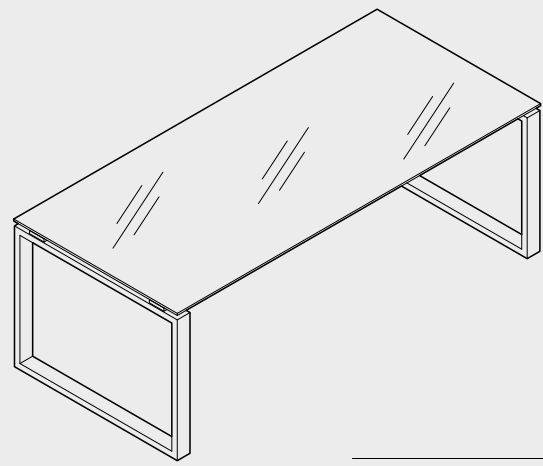

Scrivanía con piano in vetro
Desk with glass top

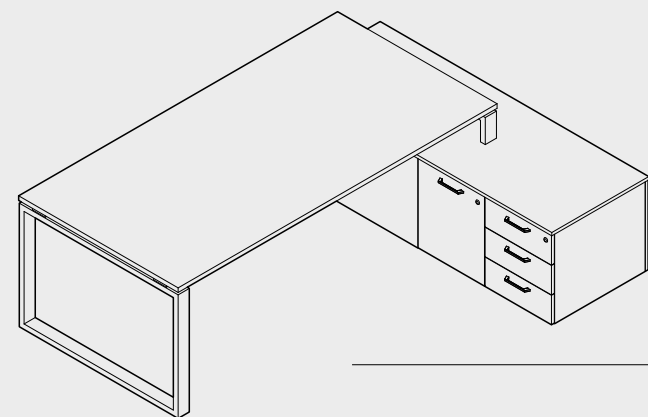

Scrivanía con piano in melaminico e mobile di servizio
Desk with melamine top and service unit

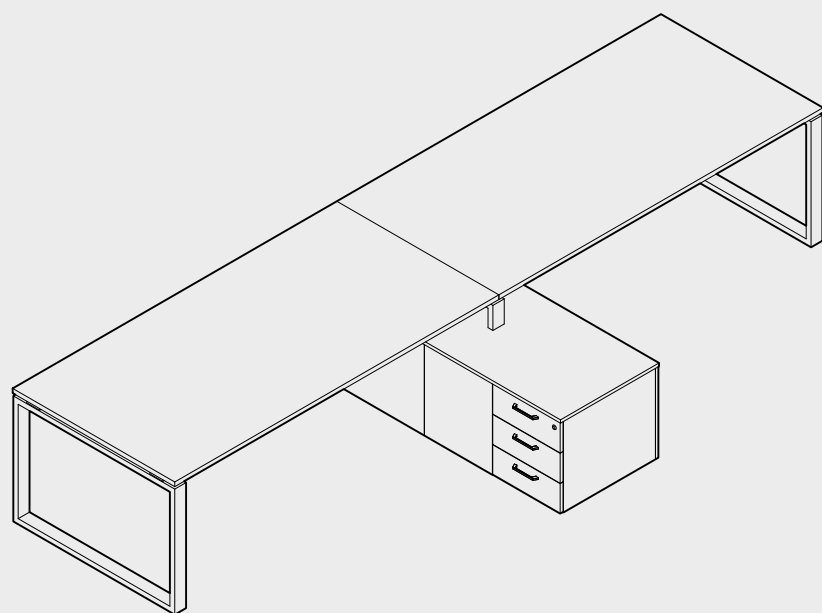

Scrivanie con piano in melaminico e gamba su contenitore condivisa
Desks with melamine top and leg on shared cabinet



Adattabili a qualsiasi spazio. Seduta modello CORNER.
Adaptable to any space. CORNER model armchair



Cassettiera tre cassetti piú uno con vano portacancelleria.
Chest of drawers with three drawers and stationery drawer.



Cassettiere dotate di serratura.
Chest of drawers with lock.



Scrivanie direzionali con mobili serventi. Sedute serie PRIMA, lampada fonoassorbente BQ®.
Executive desks with service units. PRIMA model managerial chairs. BQ® sound absorbing lamp.

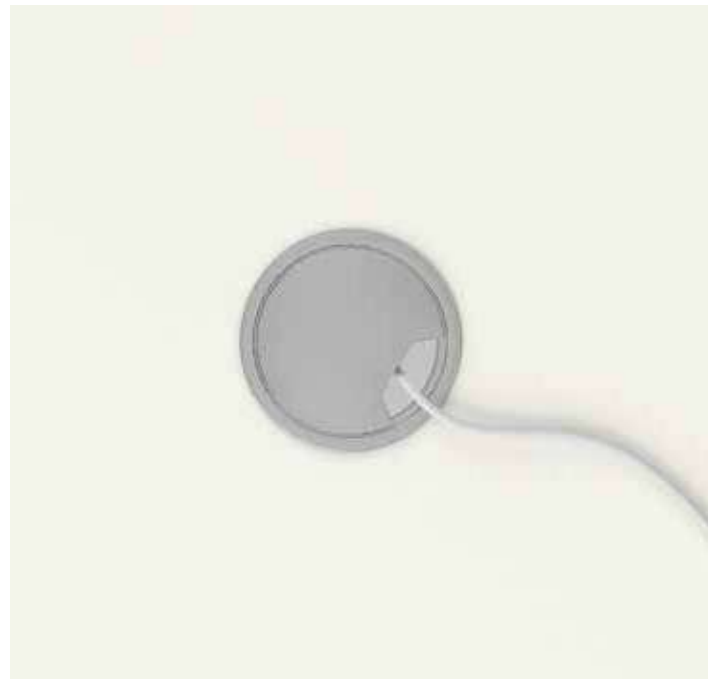

Tappo passacavi.
Cable duct cap.



Flap passacavi con apertura singola o doppia.
Cable duct flap with single or double opening.



Flap con frutti power, dati e USB recharge.
Flap with hidden jack, data and USB recharge.



Torretta con frutti power, dati e USB recharge.
Extractable turret jack, data and USB recharge.



RING

Desks
Benches
Meeting

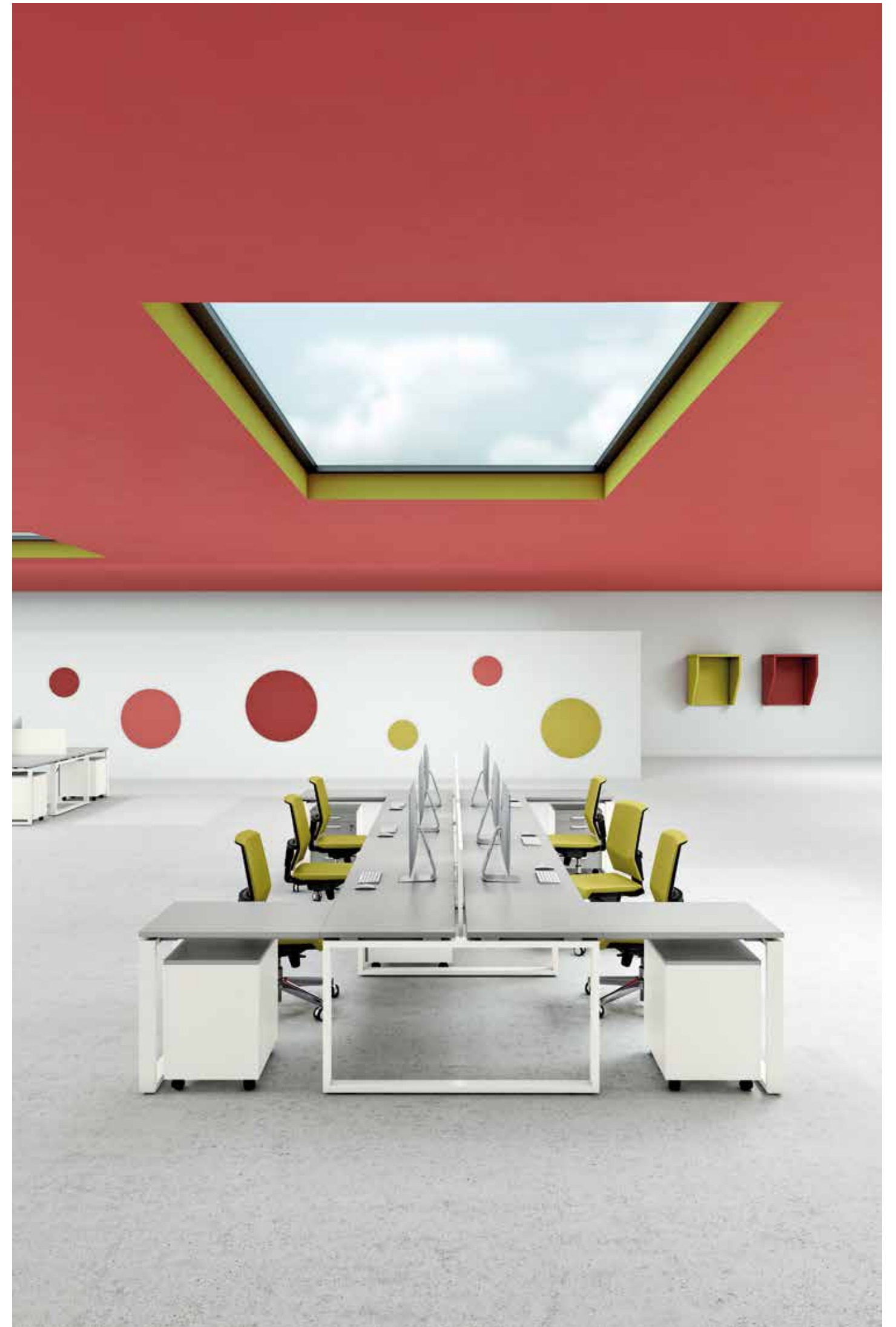

Benches due posti con screen separatorio
Benches for two seats with screen divider

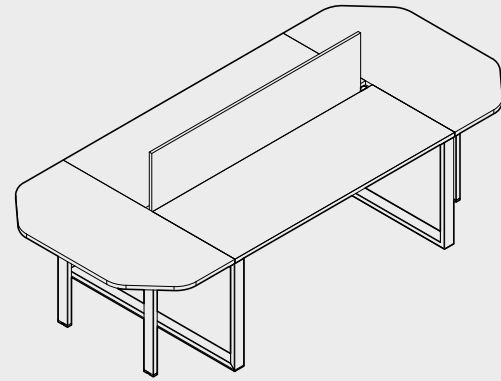

Benches quattro posti con screen separatorio
longitudinale e trasversale
Benches for four seats with longitudinal and cross
divider screens

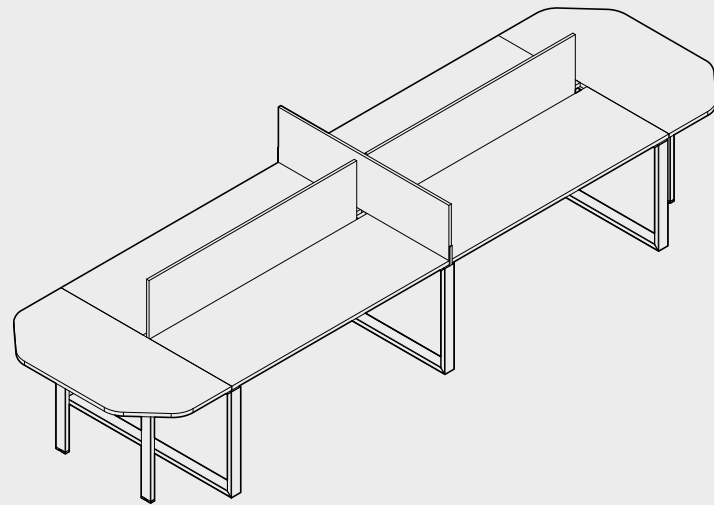

Benches quattro posti con screen separatorio
longitudinale ed appendici con contenitori o
cassettiere
Benches for four seats with longitudinal screen
divider and desk return with cabinet or chest of
drawers

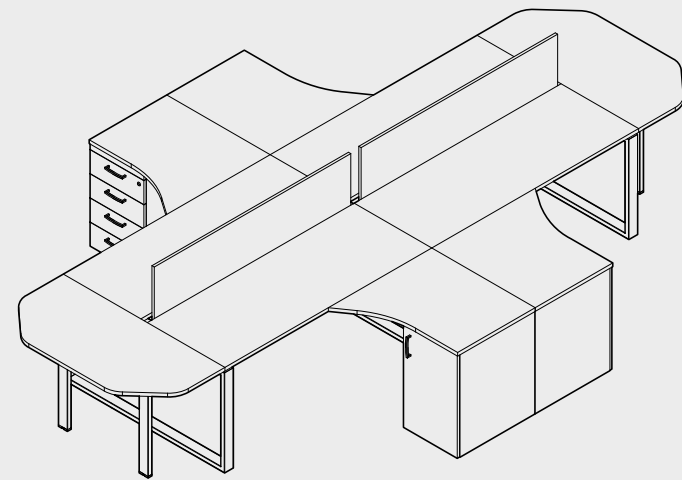

Benches quattro posti con screen separatorio
longitudinale ed appendici
Benches for four seats with longitudinal screen
divider and desk return

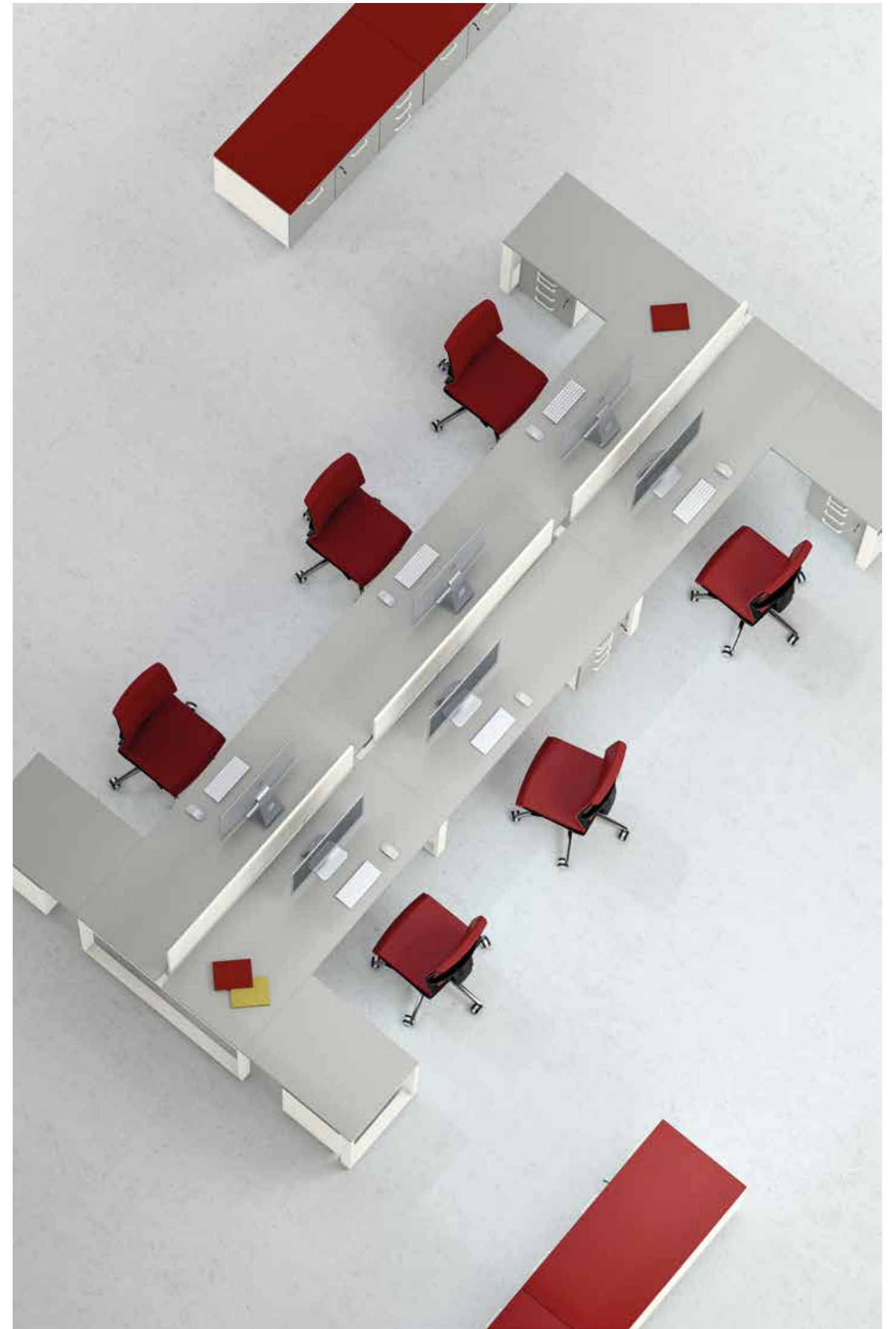
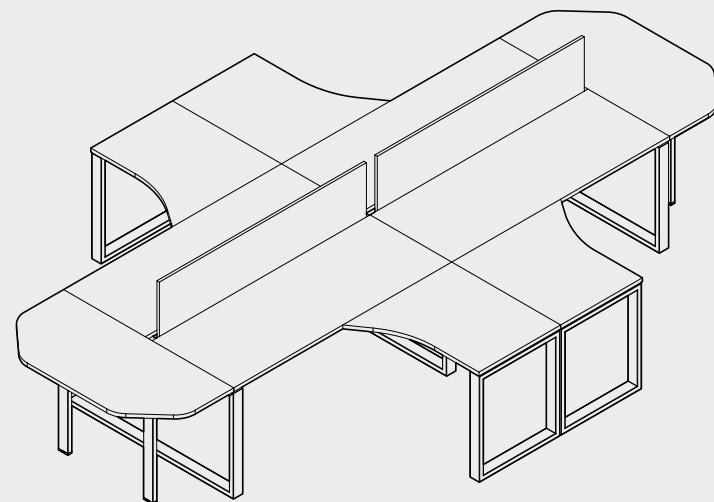



Sistemi benches, poltrone modello TELA pannelli fonoassorbenti a parete e phone booth BQ®.
Bench systems, TELA model chairs, sound absorbing wall panels and BQ® phone booth.



RING

Desk
Benches
Meeting



Tavoli riunione con piani spessore mm 18-25-30, poltrone modello COVER.
Meeting tables with 18-25-30 mm thick tops, COVER model chairs.



Tavoli meeting disponibili con diverse sagome.
Various contoured meeting tables.



Tavolo riunione retto con poltrone ALLUMINIUM.
Straight meeting table with ALLUMINIUM model chairs.

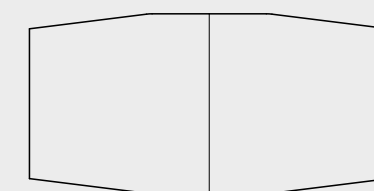

Tre sagome disponibili.
Three contoured versions

COLORE
COLOUR

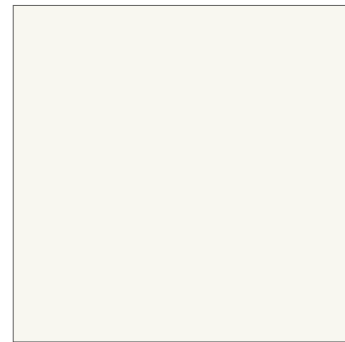

BI
Bianco
White

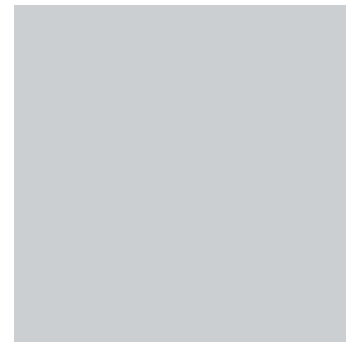

GR
Grigio
Grey



NC
Noce chiaro
Light walnut



NS
Noce scuro
Dark walnut



OC
Olmo chiaro
Light elm



OS
Olmo scuro
Dark elm



RC
Rovere chiaro
Light durmast



RT
Rovere tabacco
Durmast tobacco

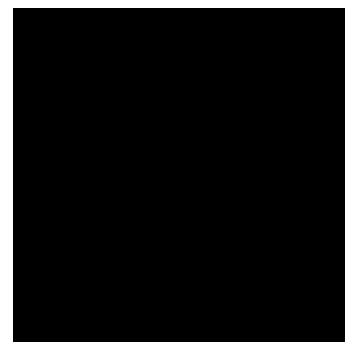

NR
Nero
Black

COLORE STRUTTURA
STRUCTURE COLOUR



BI
Bianco
White

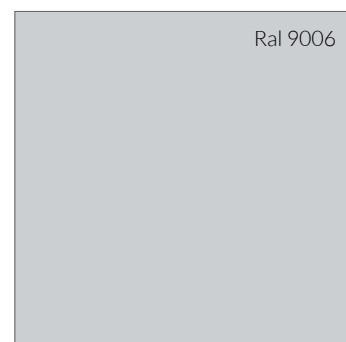

GR
Grigio
Grey

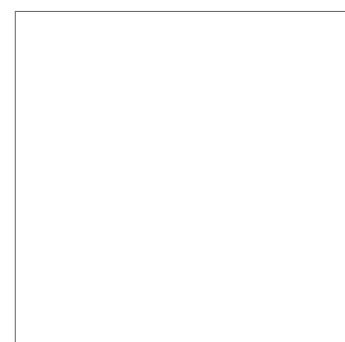

BI
Vetro bianco retro laccato
White glass lacquered back



NR
Vetro nero retro laccato
Black glass lacquered back

COLORE VETRO
GLASS COLOUR

SPESORE PIANI
TOPS THICKNESS



18
Piani spessore 18 mm
Top thickness 18 mm



25
Piani spessore 25 mm
Top thickness 25 mm



30
Piani spessore 30 mm
Top thickness 30 mm

METACRILATO
METHACRYLATE



BI
Bianco
White

TESSUTI PER ELEMENTI FONOASSORBENTI
FABRICS FOR SOUND ABSORBING ELEMENTS

Trevira C.S. 100% Poliestere ignifugo
Trevira C.S. 100% Polyester F.R.



629



426



353



358



236



332



354



625



573



356



5501



5502



5551



5451



5452



5201



5202



5301



5601



5552

MANIGLIE HANDLES



MP01.BI
Maniglia in plastica bianca
White plastic handle



MP01.GR
Maniglia in plastica grigia
Grey plastic handle



MZ02.AN
Maniglia in zamac antracite
Anthracite zinc alloy handle



MZ02.GR
Maniglia in zamac grigia
Grey zinc alloy handle



MZ01.GR
Maniglia in zamac grigia
Grey zinc alloy handle



MZ01.BI
Maniglia in zamac bianca
White zinc alloy handle



MA01.SA
Maniglia in alluminio satinato
Satin aluminium handle

ALTRE SPECIFICHE OTHER SPECIFICATIONS



Screen longitudinali e trasversali fonoassorbenti
Sound absorbing fabric longitudinal and cross screens

ELETTRIFICAZIONE ELECTRIFICATION

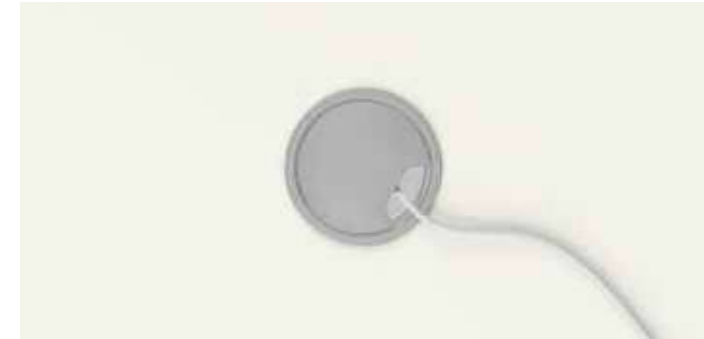

Tappo passacavi
Cable duct cap

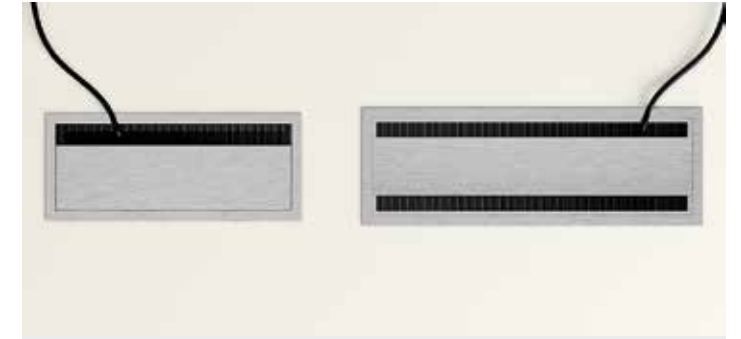

Flap passacavi con apertura singola o doppia
Cable duct flap with single or double opening



Flap con frutti power, dati e USB recharge
Flap with hidden jack, data and USB recharge



Torretta con frutti power, dati e USB recharge
Extractable turret jack, data and USB recharge



Canalina passa cavi orizzontale e verticale
Horizontal and vertical cable duct



Vertebra verticale
Vertical vertebra cable management



Porta PC sospeso e su ruote
Suspended PC case and on wheels

RING SYSTEM DESK

SCRIVANIE PIANO VETRO / GLASS DESK TOPS

Scrivanie P. 90
Desks D. 90

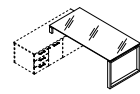
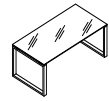

LUNGHEZZE / LENGTHS 180

SCRIVANIE IN MELAMINICO / MELAMINE DESKS

Scrivanie P. 100
Desks D. 100

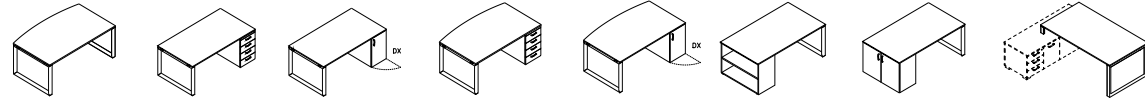

LUNGHEZZE / LENGTHS 160-180-200

Scrivanie P. 90
Desks D. 90



LUNGHEZZE / LENGTHS 160-180-200

Scrivanie P. 80
Desks D. 80



LUNGHEZZE / LENGTHS 160-180-200

Scrivanie P. 60
Desks D. 60



LUNGHEZZE / LENGTHS 160-180-200

WORKSTATION / WORKSTATIONS

Workstations
Workstations



LUNGHEZZE / LENGTHS 160X140 - 160X160

LUNGHEZZE / LENGTHS 180X140 - 180X160

ARTICOLI COMUNI / COMMON ITEMS

Penisole
Extensions

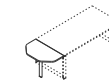

P. 60-80-100

Raccordi
Junction tops

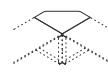

60X60-80X80-100X100

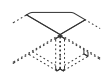

80X60-100X60-DX

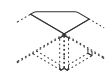

80X60-100X60-SX

Appendici P.60
Extensions D. 60

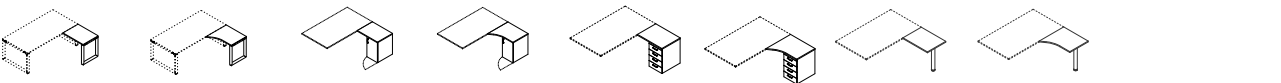

LUNGHEZZE / LENGTHS 80-100-120

Complanare
Complanars

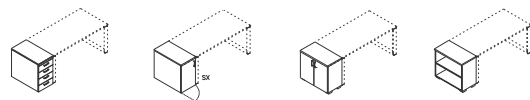

Schermi H. 35-50
Screen H. 35-50



LUNGHEZZE / LENGTHS 72-92-112-132-152-172

RING SYSTEM BENCHES

BENCHES / BENCHES

P. 125
D. 125

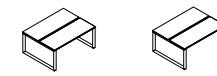

LUNGHEZZE / LENGTHS 80-100-120-140-160-180

P. 165
D. 165

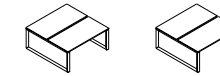

LUNGHEZZE / LENGTHS 80-100-120-140-160-180

ALLUNGHI E APPENDICI / EXTENSIONS

Terminale P. 125
Terminal extension
D. 125

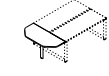

LUNGHEZZA / LENGTH 60

Terminale P. 165
Terminal extension
D. 165

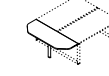

LUNGHEZZA / LENGTH 60

Appendici P.60
Extension D. 60

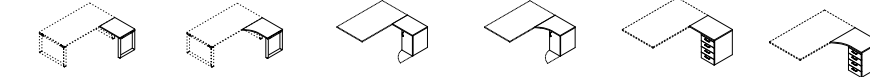

LUNGHEZZE / LENGTHS 80-100-120

SCHERMI / SCREENS

Schermi H. 35-50
Screens H. 35-50

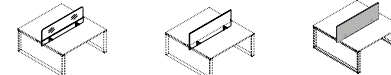

LONGITUDINALI LUNGHEZZE • LONGITUDINAL LENGTHS 72-92-112-132-152-172

RING SYSTEM MEETING

TAVOLI RIUNIONE / MEETING TABLES

P. 100
D. 100

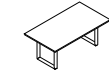

LUNGHEZZE / LENGTHS 180-200-220

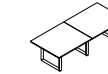

240-280

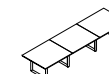

>280

P. 120
D. 120

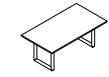

LUNGHEZZE / LENGTHS 180-200-220

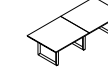

240-280

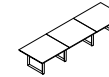

>280

TAVOLI RIUNIONE SAGOMATI / CONTOURED MEETING TABLES

P. 100
D. 100

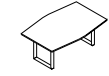

LUNGHEZZE / LENGTHS 180-200-220

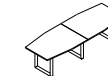

240-280

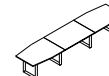

>280

P. 120
D. 120

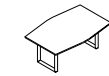

LUNGHEZZE / LENGTHS 180-200-220

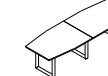

240-280

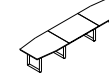

>280

TAVOLI RIUNIONE OVALI / OVAL MEETING TABLES

P. 100
D. 100

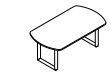

LUNGHEZZE / LENGTHS 180-200-220

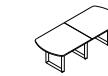

240-280

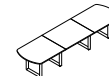

>280

P. 120
D. 120

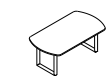

LUNGHEZZE / LENGTHS 180-200-220



240-280

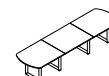

>280

BRIDGE

Desks
Benches
Meeting



Bridge è una linea di scrivanie direzionali ed operative allo stesso tempo, con piani spessore mm 18-25-30. Disponibile anche il piano in vetro bianco e nero retro laccato. La struttura metallica in due colori e le varie forme e misure, ne consentono una ottima flessibilità nella configurazione in contesti anche diversi dall'ufficio. Poltrone modello Corner.

Bridge is a line of both executive and operative desks with 18-25-30 mm thick tops. It is also available with a black or white glass top and lacquered back. A metal structure in two colors and in various shapes and sizes allow for an excellent flexibility for different configured contexts besides offices. CORNER model armchairs.



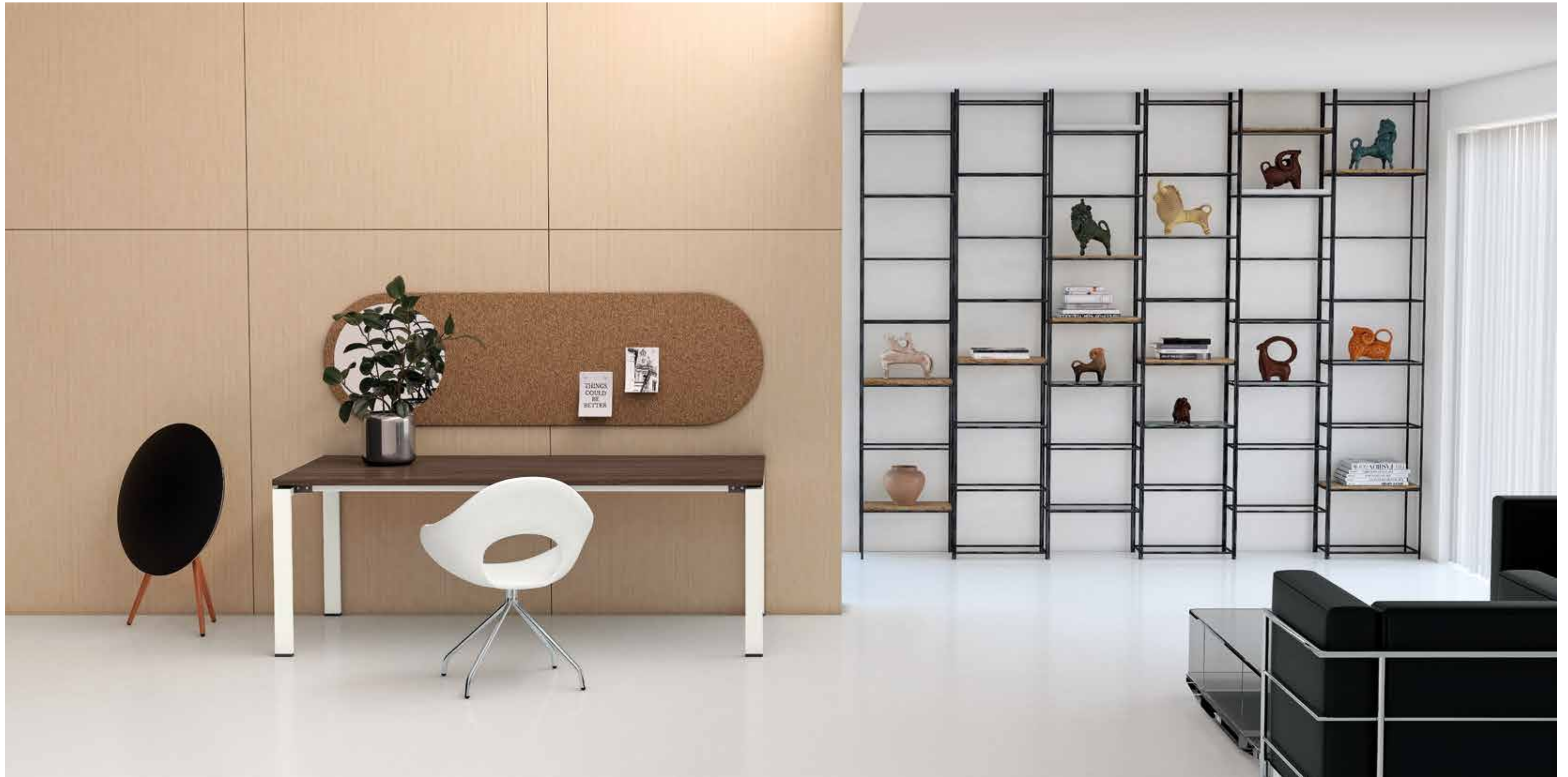

Scrivania BRIDGE. Poltrona Modello CORNER. Divano Modello TENDER.

BRIDGE desk, CORNER. model armchair, TENDER model couch.

Scrivania con piano in vetro
Desk with glass top

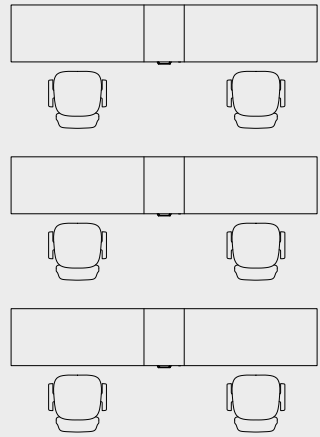
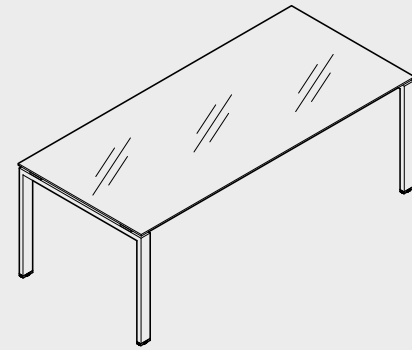

Scrivanie affiancate con cassetiera complanare al servizio
Flanked desks with coplanar chest of drawers service unit

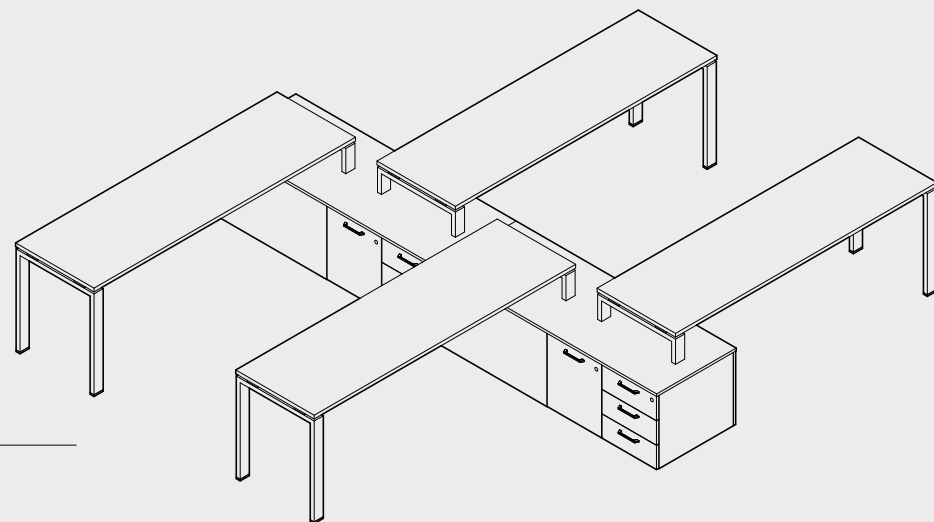
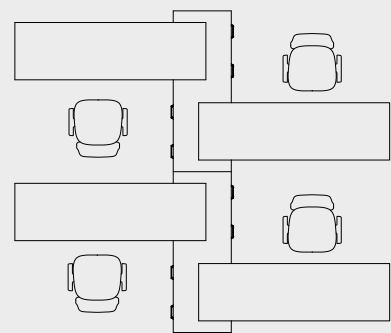
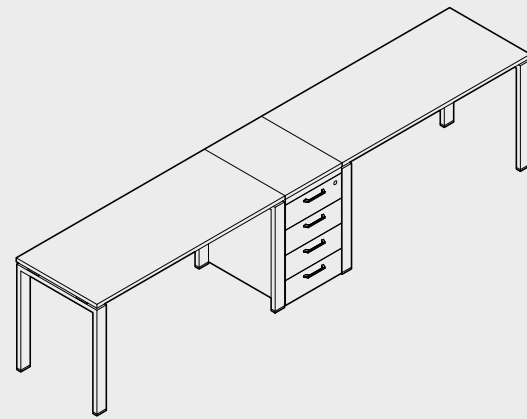

Posti di lavoro con elemento di servizio comune
Work spaces with common service unit element





Scrivanie affiancate con cassetiera complanare al servizio. Poltrona modello Cover.
Flanked desks with coplanar chest of drawers service unit, Cover model chairs.

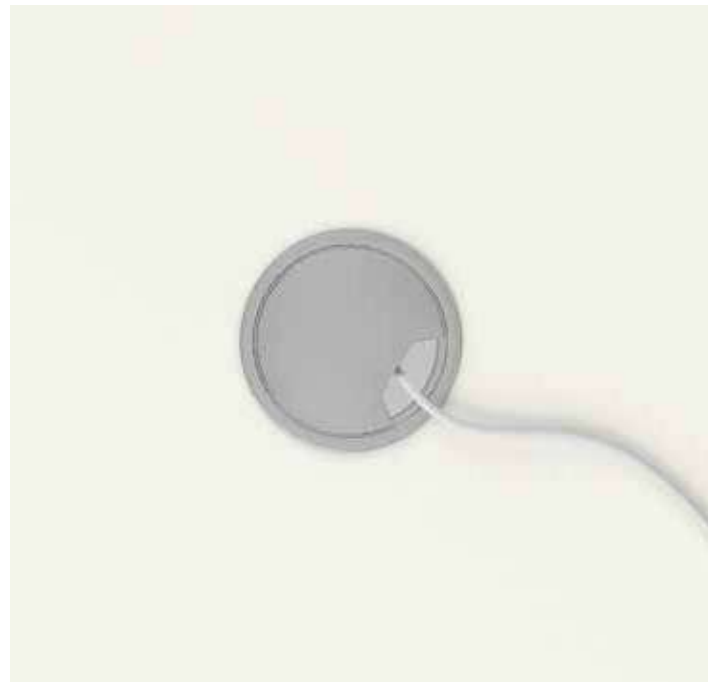

Tappo passacavi.
Cable duct cap.



Flap passacavi con apertura singola o doppia.
Cable duct flap with single or double opening.



Flap con frutti power, dati e USB recharge.
Flap with hidden jack, data and USB recharge.



Torretta con frutti power, dati e USB recharge.
Extractable turret jack, data and USB recharge.



BRIDGE

Desks
Benches
Meeting

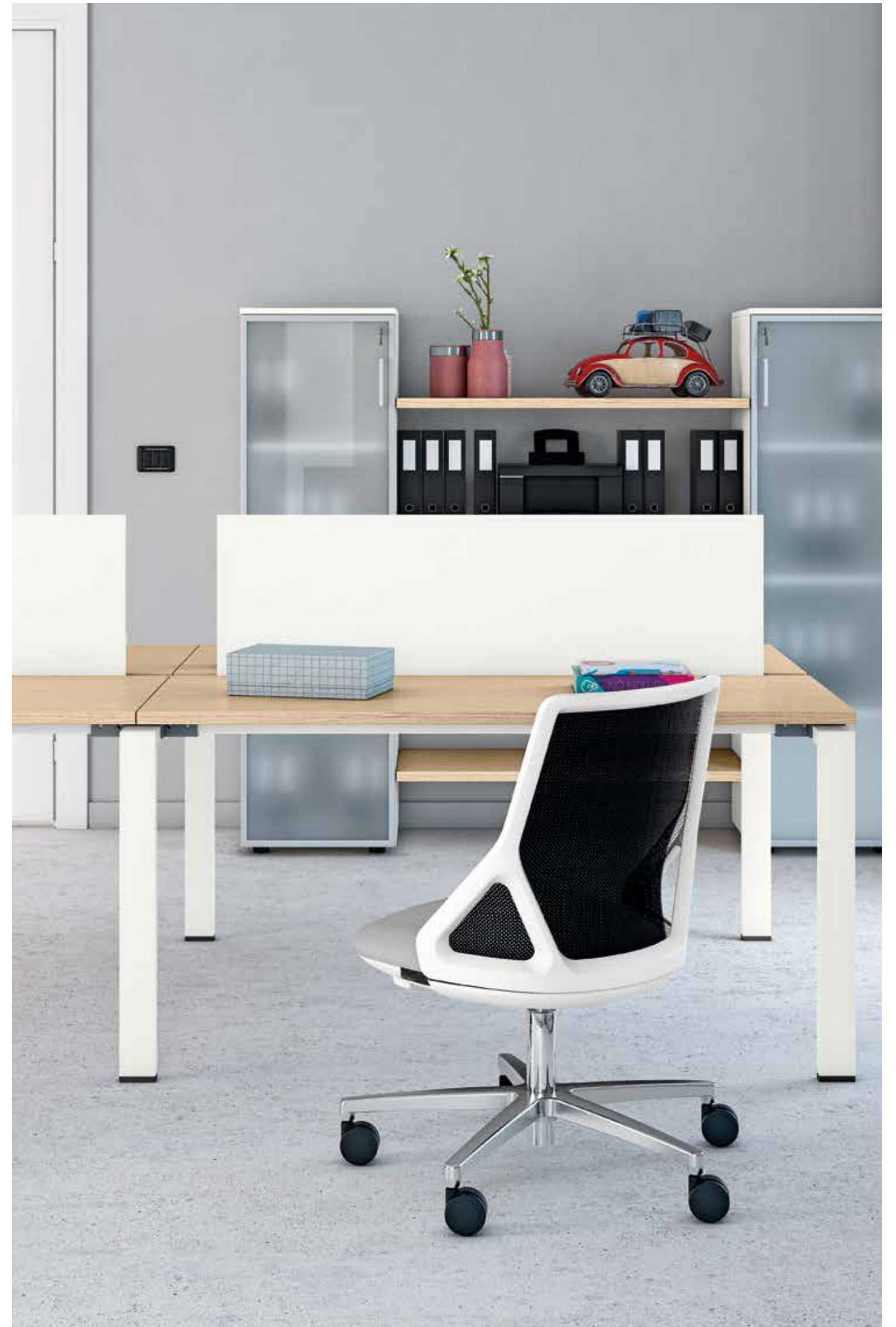

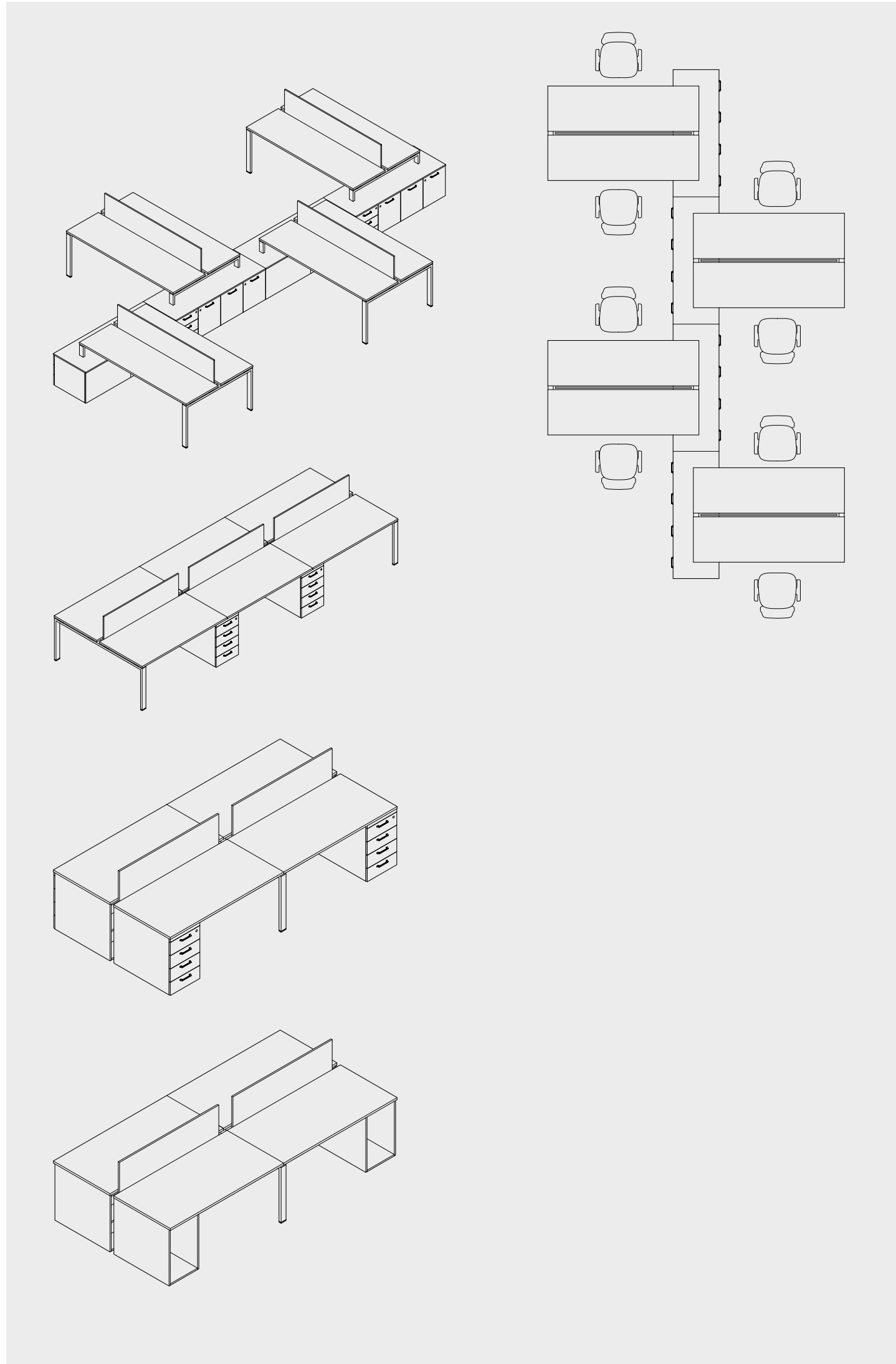



Benches con screen separatori longitudinali. Librerie RIVER. Sedute modello COVER.
Benches with longitudinal screen dividers, RIVER bookcases, COVER model chairs.



BRIDGE

Desk
Benches
Meeting

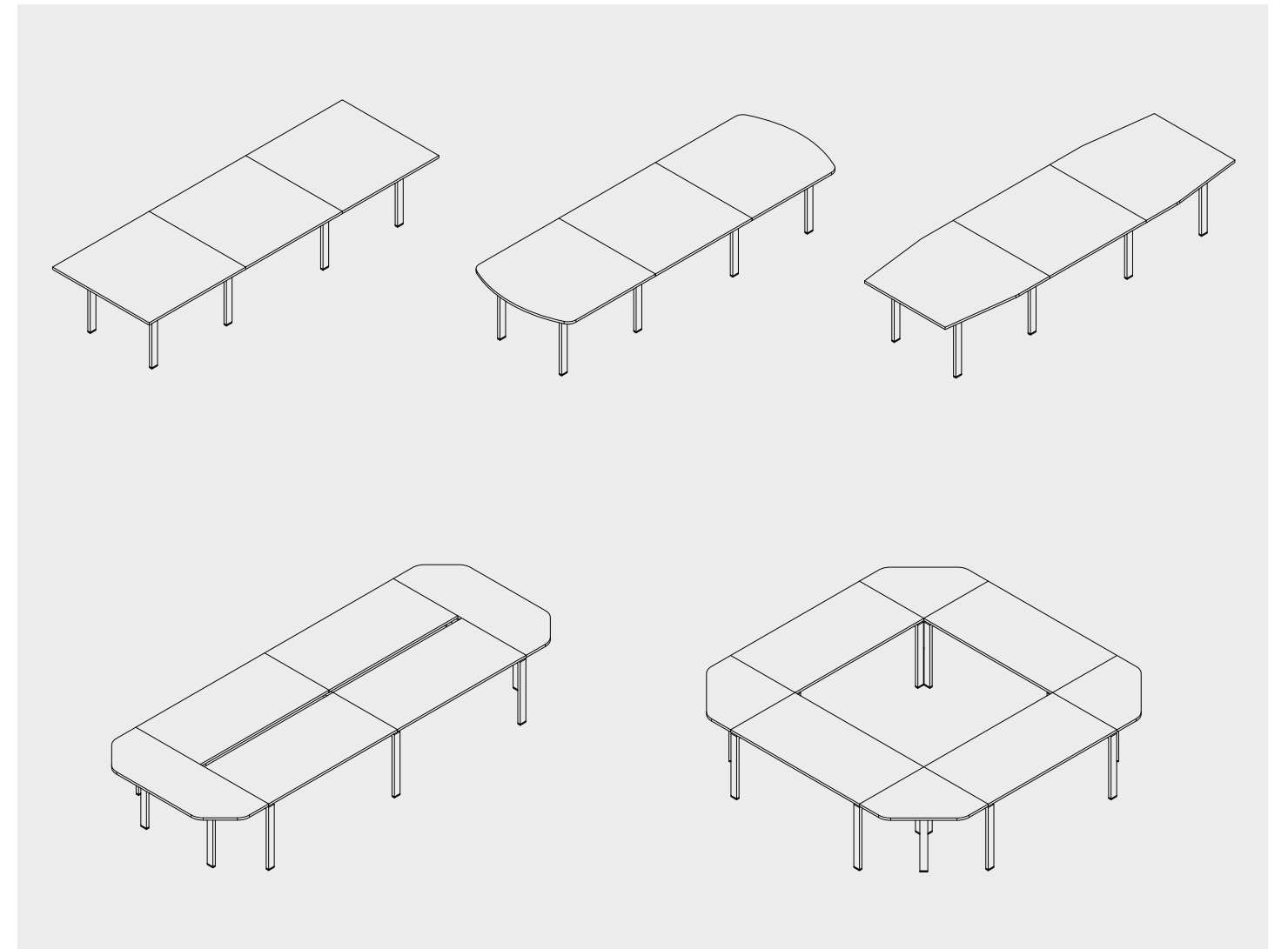

Tavoli riunione composti, configurabili per qualsiasi esigenza di spazio.
Composed meeting tables which can be configured for various spaces.



Diverse sagome disponibili.
Various shapes available.



Tavoli riunioni BRIDGE. Sedute girevoli modello BOSS. Sedute fisse modello DELIGHT. Paretine divisorie, pannelli a parete, lampade BQ®.
BRIDGE meeting tables, BOSS model swivel chairs, DELIGHT model fixed chairs, sound absorbing fabric wall dividers, wall panels and BQ® lamps.

COLORE
COLOUR

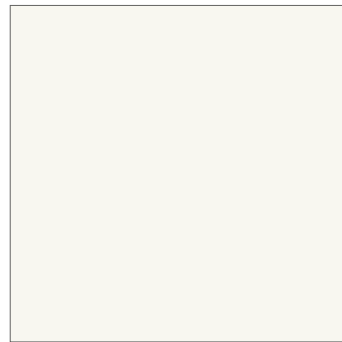

BI
Bianco
White

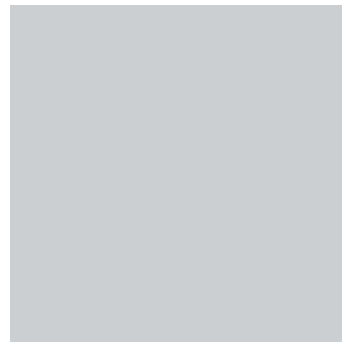

GR
Grigio
Grey



NC
Noce chiaro
Light walnut



NS
Noce scuro
Dark walnut



OC
Olmo chiaro
Light elm



OS
Olmo scuro
Dark elm



RC
Rovere chiaro
Light durmast



RT
Rovere tabacco
Durmast tobacco

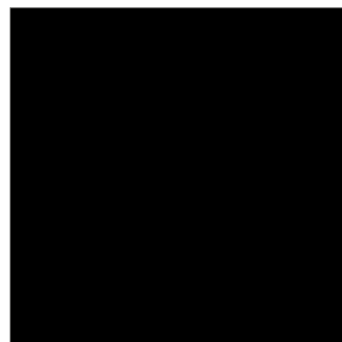

NR
Nero
Black

COLORE STRUTTURA
STRUCTURE COLOUR

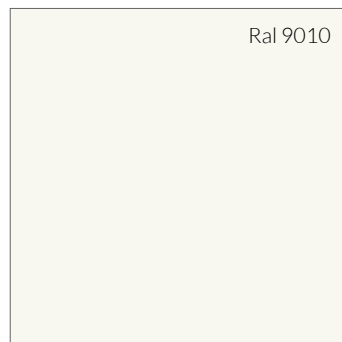

BI
Bianco
White



GR
Grigio
Grey

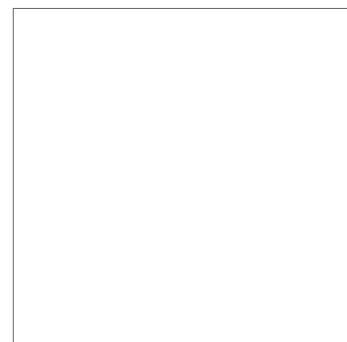

BI
Vetro bianco retro laccato
White glass lacquered back



NR
Vetro nero retro laccato
Black glass lacquered back

COLORE VETRO
GLASS COLOUR

SPESORE PIANI
TOPS THICKNESS



18
Piani spessore 18 mm
Top thickness 18 mm



25
Piani spessore 25 mm
Top thickness 25 mm



30
Piani spessore 30 mm
Top thickness 30 mm

METACRILATO
METHACRYLATE

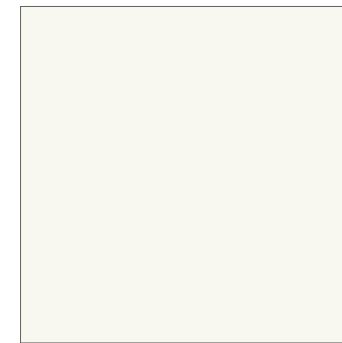

BI
Bianco
White

TESSUTI PER ELEMENTI FONOASSORBENTI
FABRICS FOR SOUND ABSORBING ELEMENTS

Trevira C.S. 100% Poliestere ignifugo
Trevira C.S. 100% Polyester F.R.



629



426



353



358



236



332



354



625



573



356



5501



5502



5551



5451



5452



5201



5202



5301



5601



5552

MANIGLIE HANDLES



MP01.BI
Maniglia in plastica bianca
White plastic handle



MP01.GR
Maniglia in plastica grigia
Grey plastic handle



MZ02.AN
Maniglia in zamac antracite
Anthracite zinc alloy handle



MZ02.GR
Maniglia in zamac grigia
Grey zinc alloy handle



MZ01.GR
Maniglia in zamac grigia
Grey zinc alloy handle



MZ01.BI
Maniglia in zamac bianca
White zinc alloy handle



MA01.SA
Maniglia in alluminio satinato
Satin aluminium handle

ALTRE SPECIFICHE OTHER SPECIFICATIONS



Screen longitudinali e trasversali fonoassorbenti
Sound absorbing fabric longitudinal and cross screens

ELETTRIFICAZIONE ELECTRIFICATION

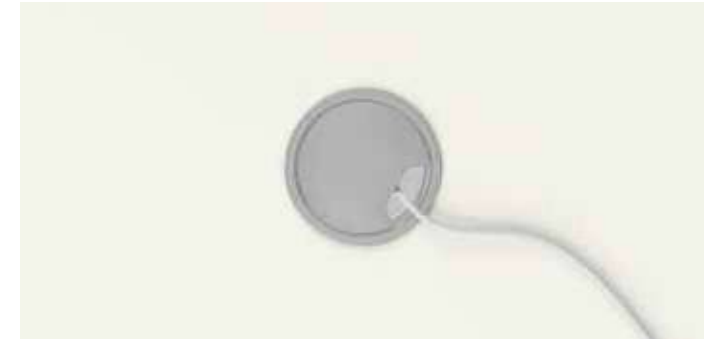

Tappo passacavi
Cable duct cap

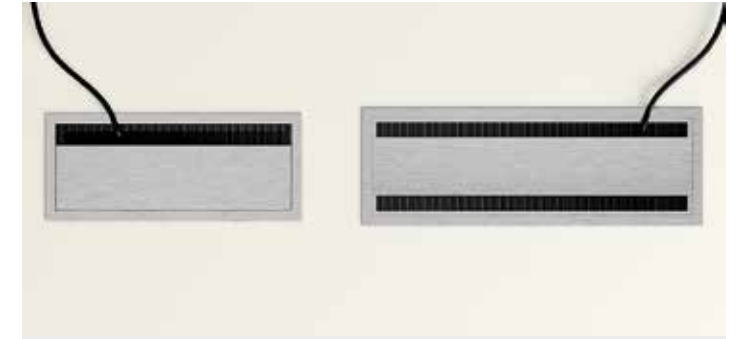

Flap passacavi con apertura singola o doppia
Cable duct flap with single or double opening



Flap con frutti power, dati e USB recharge
Flap with hidden jack, data and USB recharge



Torretta con frutti power, dati e USB recharge
Extractable turret jack, data and USB recharge



Canalina passa cavi orizzontale e verticale
Horizontal and vertical cable duct



Vertebra verticale
Vertical vertebra cable management



Porta PC sospeso e su ruote
Suspended PC case and on wheels

BRIDGE SYSTEM DESK

SCRIVANIE PIANO VETRO / GLASS DESK TOPS



SCRIVANIE IN MELAMINICO / MELAMINE DESKS

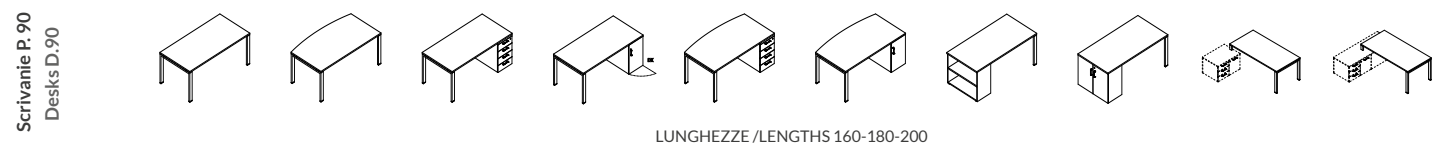
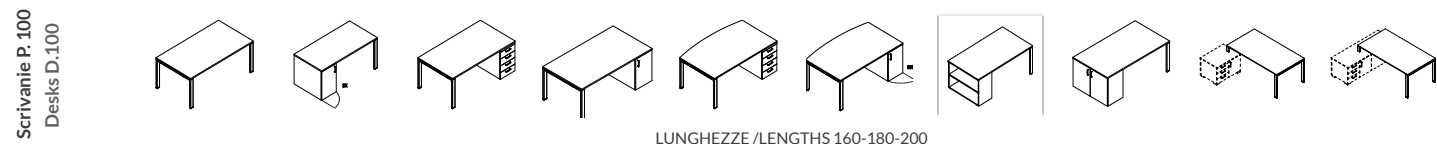

WORKSTATION / WORKSTATIONS

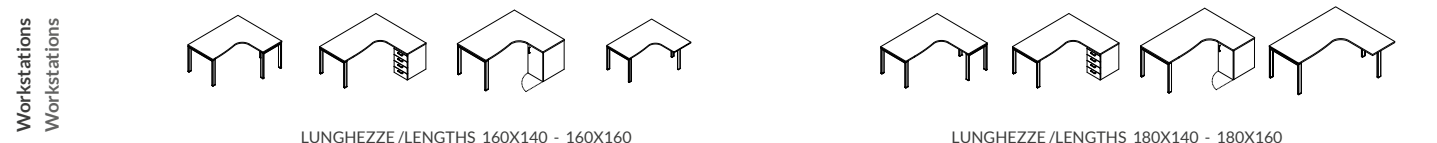

ARTICOLI COMUNI / COMMON ITEMS

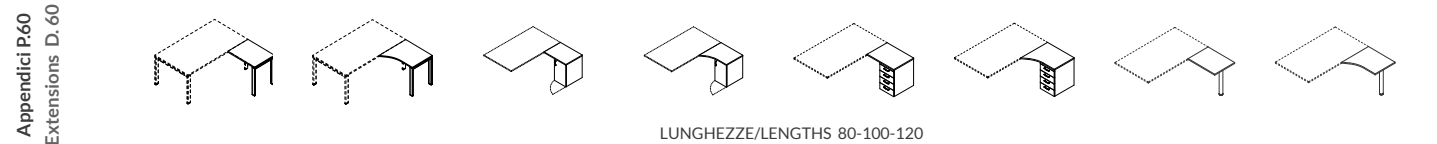
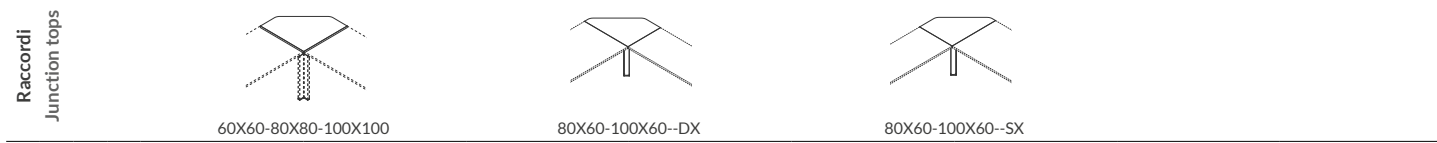

BRIDGE SYSTEM BENCHES

BENCHES / BENCHES



ALLUNGHI ED APPENDICI / EXTENSIONS

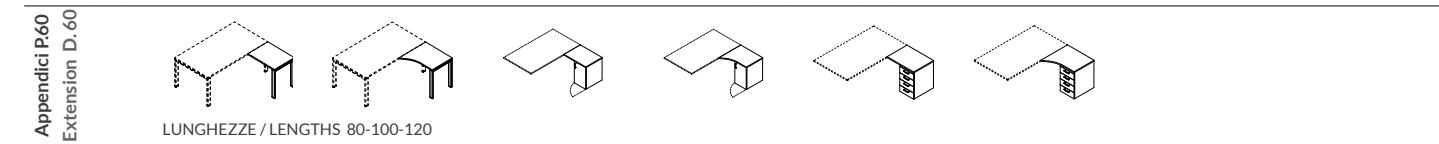

SCHERMI / SCREENS



BRIDGE SYSTEM MEETING

TAVOLI RIUNIONE / MEETING TABLES

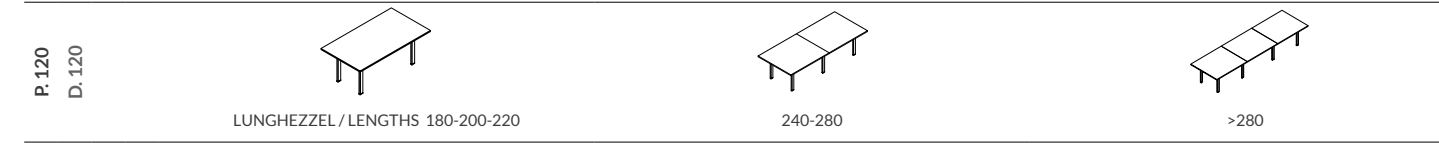
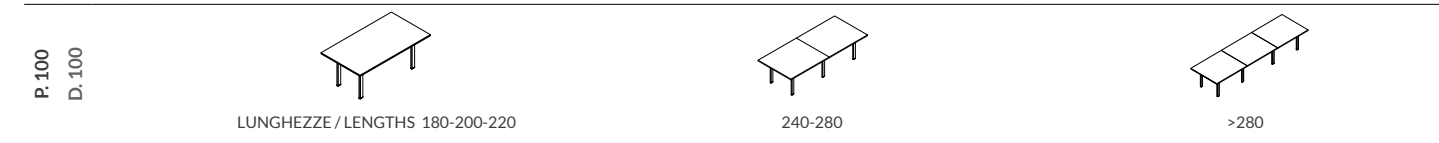

TAVOLI RIUNIONE SAGOMATI / CONTOURED MEETING TABLES

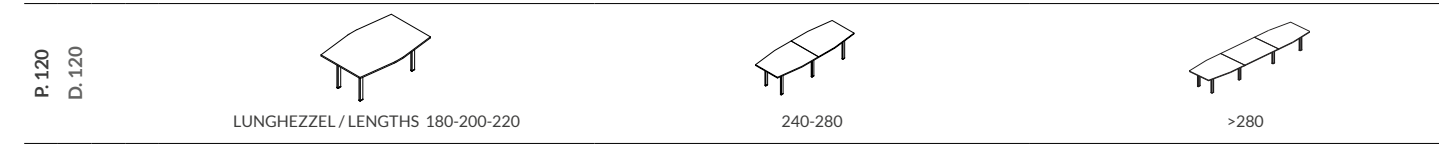
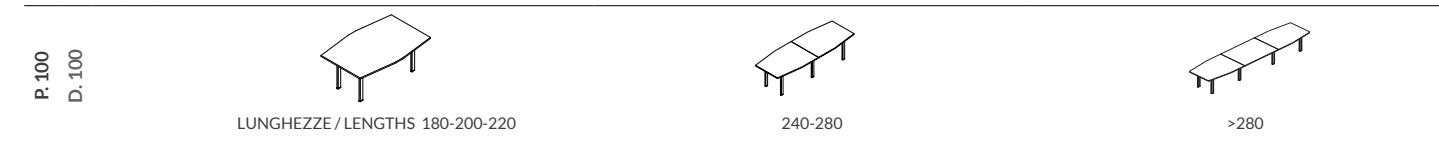

TAVOLI RIUNIONE OVALI / OVAL MEETING TABLES

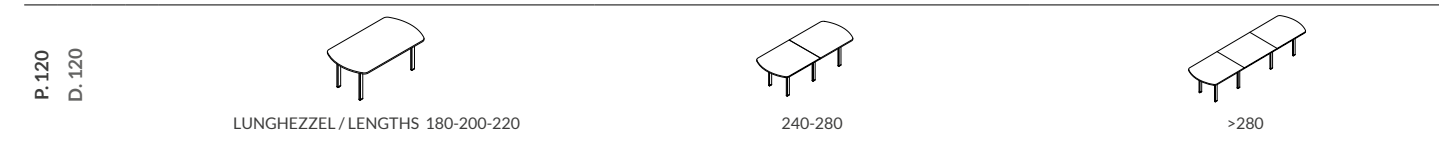
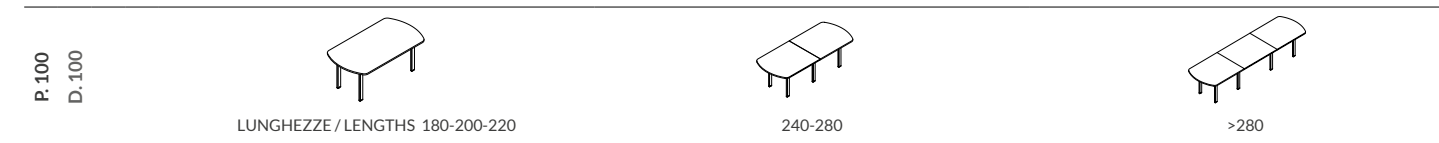

T-LEG

Desks
Call
Meeting



T-Leg è una linea di arredi direzionali ed operativi allo stesso tempo, con piani spessore mm 25-30. Disponibile anche le strutture regolabili elettricamente singole e doppie. La struttura metallica in due colori e le varie forme e misure, ne consentono una ottima flessibilità nella configurazione di ambienti per molteplici esigenze. Poltrone modello Tela e Boss.

T-Leg is a line of both executive and operative desks with 25-30 mm thick tops. Single and double electrically adjustable structures are also available. A metal structure in two colors and in various shapes and sizes allow for an excellent flexibility for different configured environments for multiple needs. Tela and Boss model chairs.





Scrivania regolabile in altezza elettricamente con relativa poltrona mod. TRIADE.
Electrical height adjustable desk with TRIADE model chairs.



Display di regolazione con memorie.
Adjustable memory display.



Struttura per scrivania doppia.
Structure for two desks.



Strutture per scrivanie singole.
Structures for single desks.

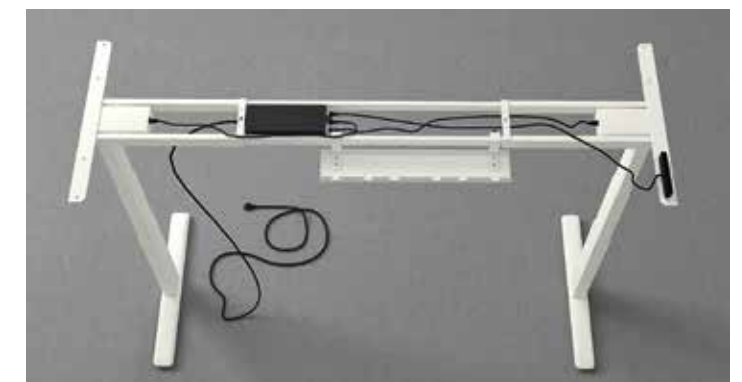

Canalizzazione struttura.
Cable management structure.



Scrivanie T-LEG. Poltrone girevoli modello ZOE. Sedie fisse modello SNACK.
T-LEG desk, ZOE model swivel chairs, SNACK model fixed chairs.



Scrivania con appendice cassettiera.
Desk with return unit and chest of drawers.



Scrivania con appendice contenitore.
Desk with return unit and cabinet.



Scrivania regolabile in altezza.
Height adjustable desk.



Workstation.



T-LEG

Desks
Call
Meeting

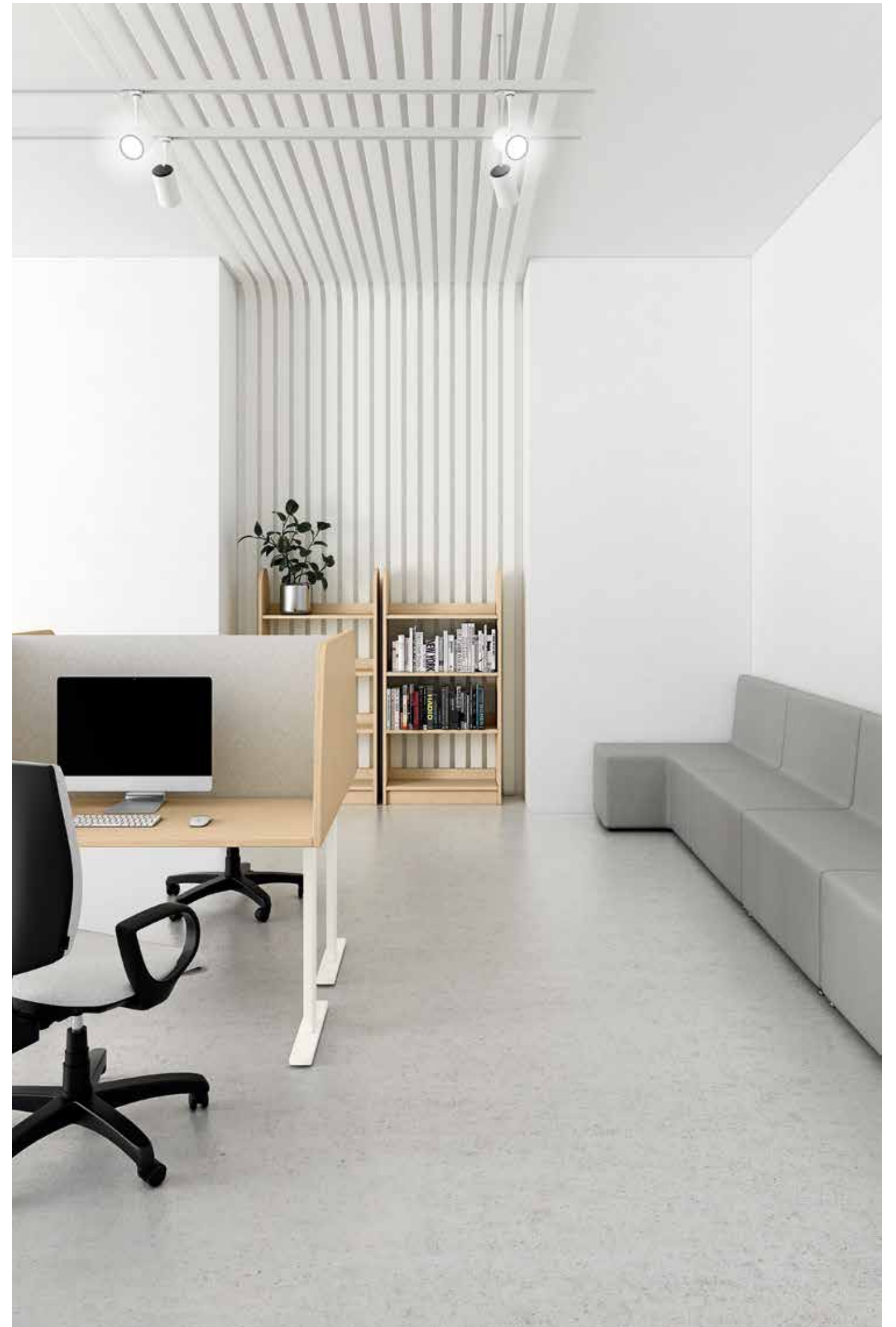



Call T-LEG doppi con schermo fonoassorbente. Libreria ONIX. Sedute TRIADE rete.
T-LEG call double with sound absorbing fabric screen. ONIX bookcase. TRIADE mesh chairs.

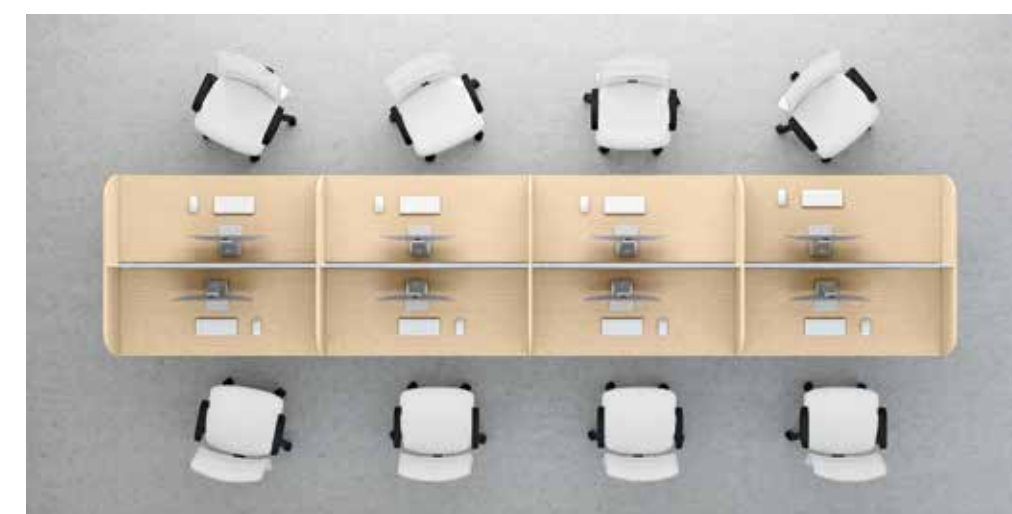



T-LEG

Desks
Call
Meeting





Tavoli riunione composti con piani di diverse sagome.
Composed meeting tables with various contoured tops.

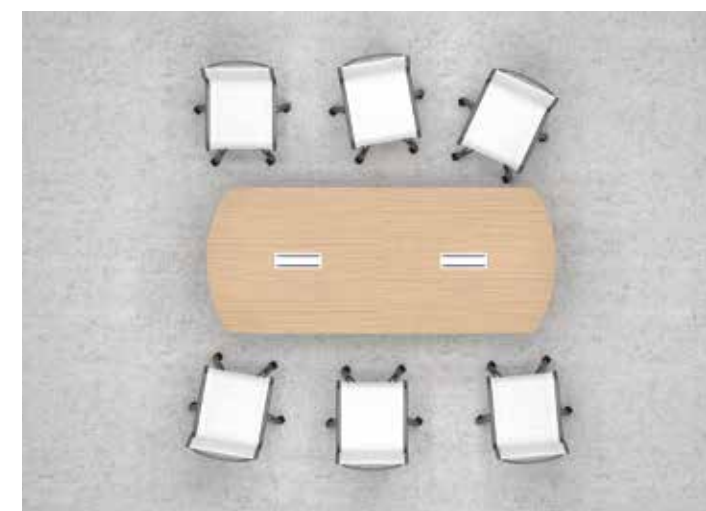

COLORE
COLOUR

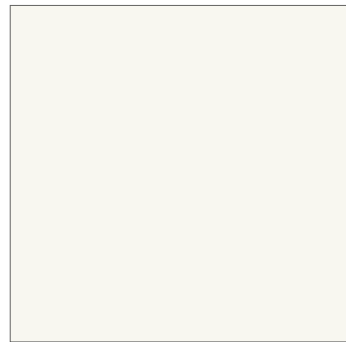

BI
Bianco
White

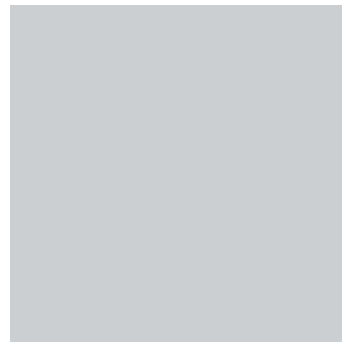

GR
Grigio
Grey



NC
Noce chiaro
Light walnut



NS
Noce scuro
Dark walnut



OC
Olmo chiaro
Light elm



OS
Olmo scuro
Dark elm



RC
Rovere chiaro
Light durmast



RT
Rovere tabacco
Durmast tobacco

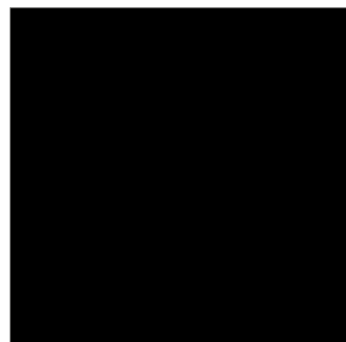

NR
Nero
Black

COLORE STRUTTURA
STRUCTURE COLOUR



BI
Bianco
White

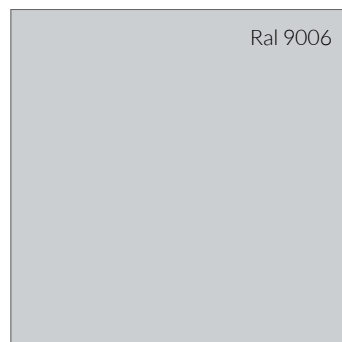

GR
Grigio
Grey

METACRILATO
METHACRYLATE

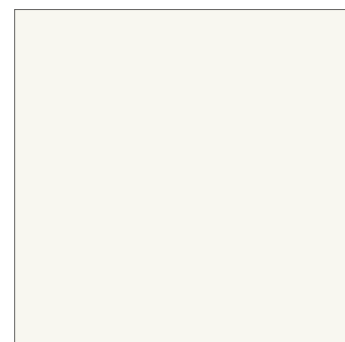

BI
Bianco
White

SPESSORE PIANI
TOPS THICKNESS

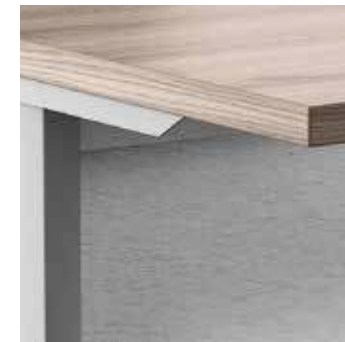

25
Piani spessore 25 mm
Top thickness 25 mm

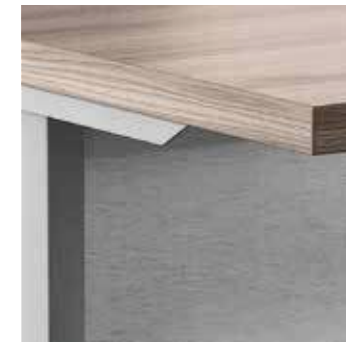

30
Piani spessore 30 mm
Top thickness 30 mm

TESSUTI PER ELEMENTI FONOASSORBENTI
FABRICS FOR SOUND ABSORBING ELEMENTS

Trevira C.S. 100% Poliestere ignifugo
Trevira C.S. 100% Polyester F.R.



629



426



353



358



236



332



354



625



573



356



5501



5502



5551



5451



5452



5201



5202



5301



5601



5552

MANIGLIE HANDLES



MP01.BI
Maniglia in plastica bianca
White plastic handle



MP01.GR
Maniglia in plastica grigia
Grey plastic handle



MZ02.AN
Maniglia in zamac antracite
Anthracite zinc alloy handle



MZ02.GR
Maniglia in zamac grigia
Grey zinc alloy handle



MZ01.GR
Maniglia in zamac grigia
Grey zinc alloy handle



MZ01.BI
Maniglia in zamac bianca
White zinc alloy handle



MA01.SA
Maniglia in alluminio satinato
Satin aluminium handle

ALTRE SPECIFICHE OTHER SPECIFICATIONS



Screen longitudinali e trasversali fonoassorbenti.
Longitudinal and cross sound absorbing fabric screens.

ELETTRIFICAZIONE ELECTRIFICATION

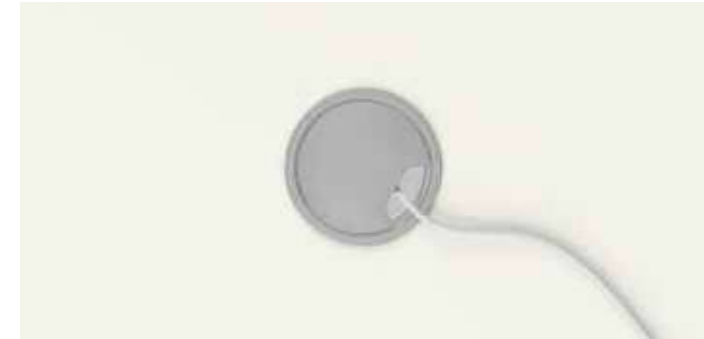

Tappo passacavi
Cable duct cap

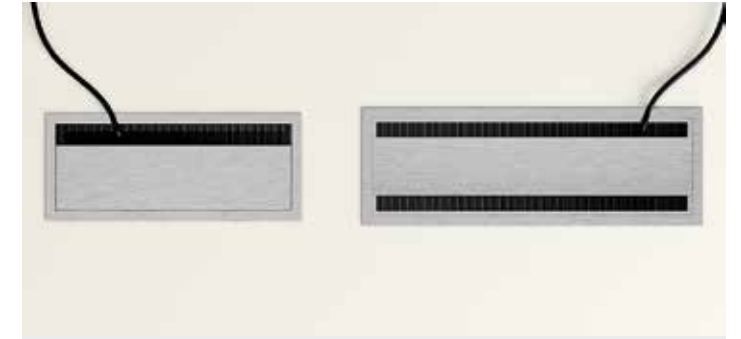

Flap passacavi con apertura singola o doppia
Cable duct flap with single or double opening



Flap con frutti power, dati e USB recharge
Flap with hidden jack, data and USB recharge



Torretta con frutti power, dati e USB recharge
Extractable turret jack, data and USB recharge



Canalina passa cavi orizzontale e verticale.
Horizontal and vertical cable duct.



Vertebra verticale.
Vertical vertebra cable management.



Porta PC sospeso e su ruote.
Suspended PC case and on wheels.

T-LEG SYSTEM DESK

SCRIVANIE ED APPENDICI / DESKS AND EXTENSIONS

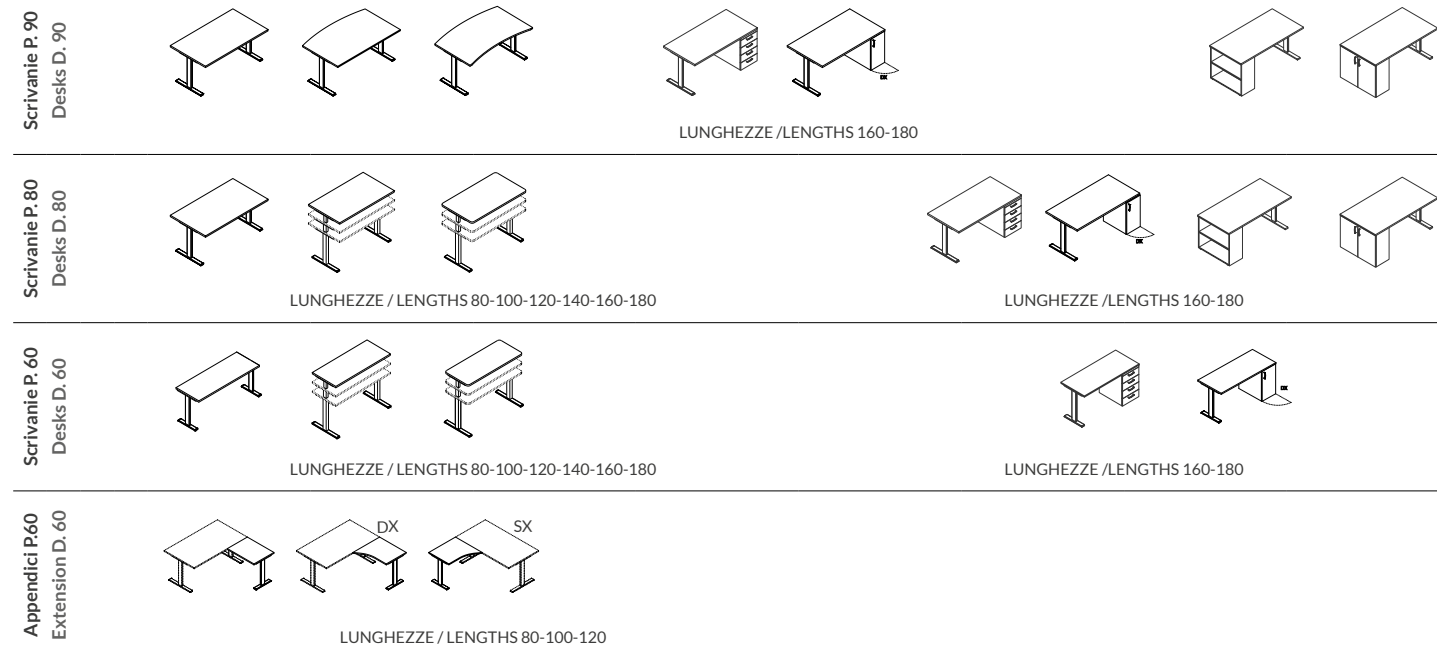

WORKSTATION / WORKSTATIONS

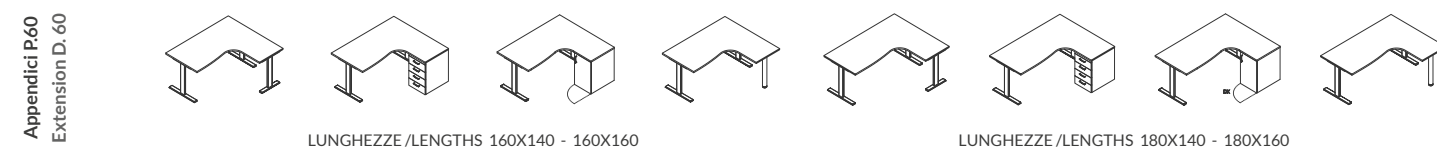

ARTICOLI COMUNI / COMMON ITEMS

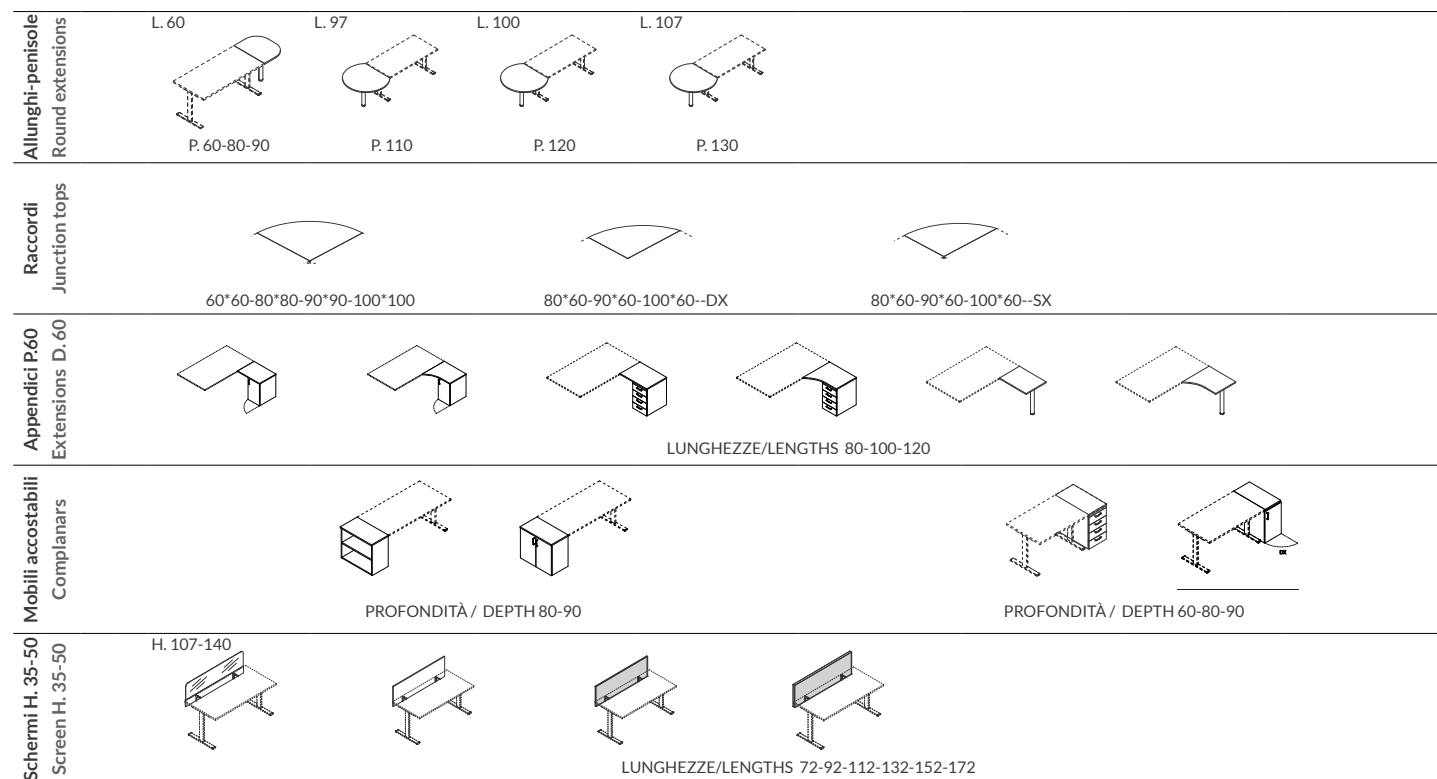

T-LEG SYSTEM CALL

CALL IN MELAMINICO / CALL IN MELAMINE

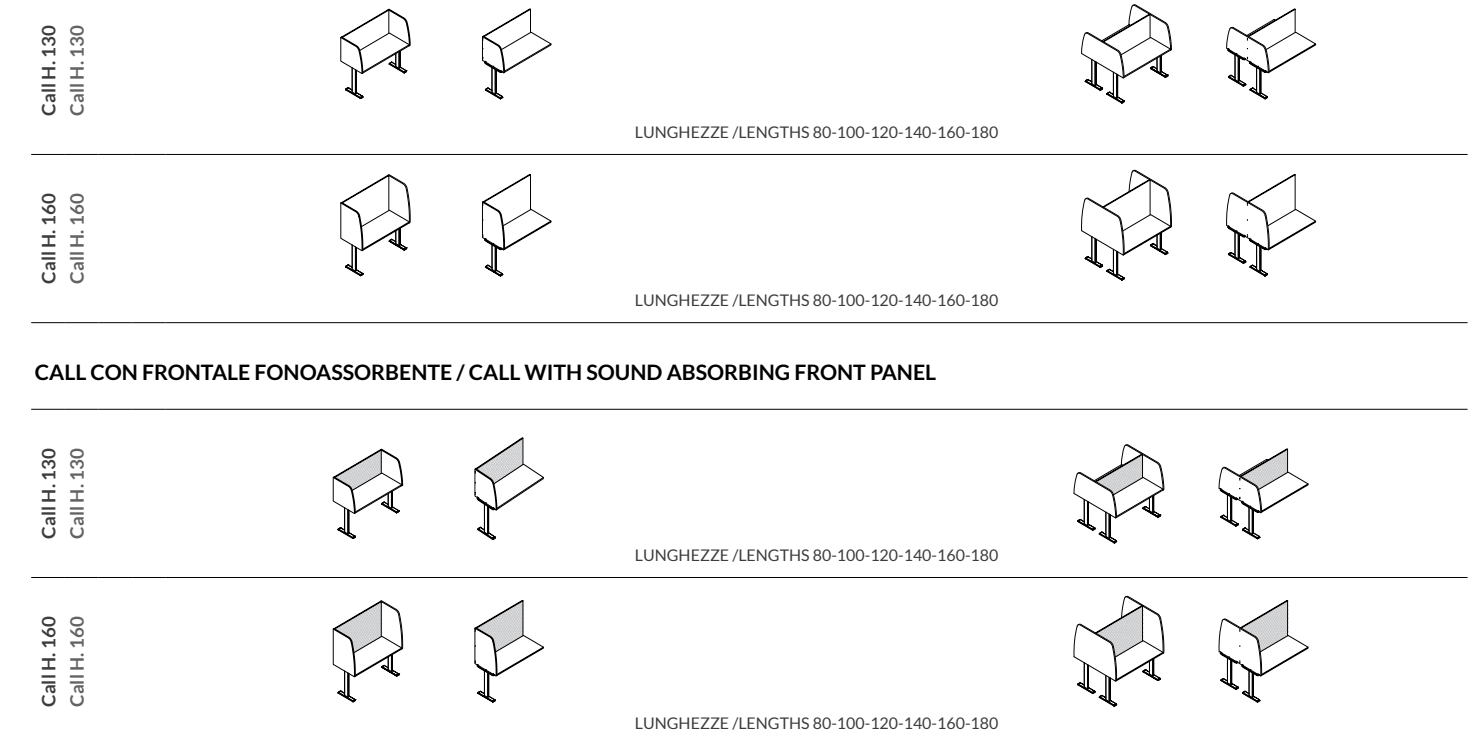

T-LEG SYSTEM MEETING

TAVOLI RIUNIONE / MEETING TABLES

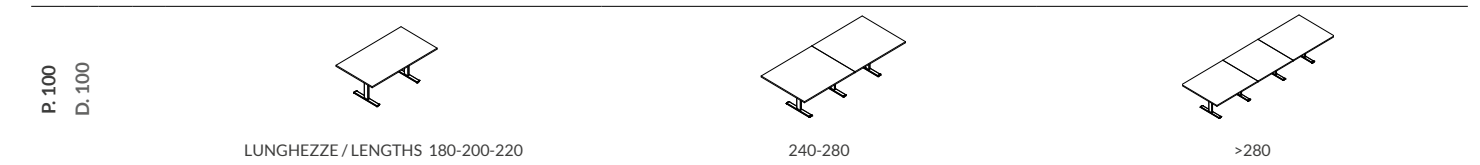

TAVOLI RIUNIONE SAGOMATI / CONTOURED MEETING TABLES

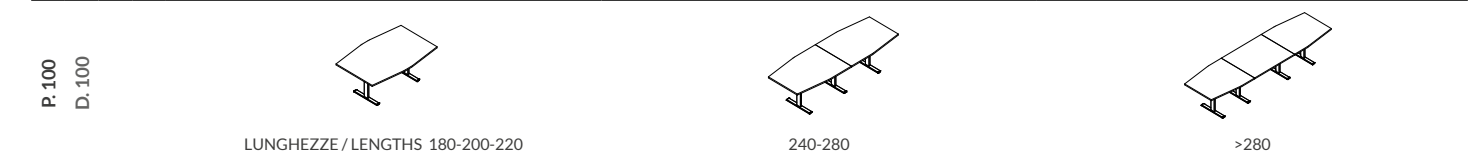

TAVOLI RIUNIONE OVALI / OVAL MEETING TABLES

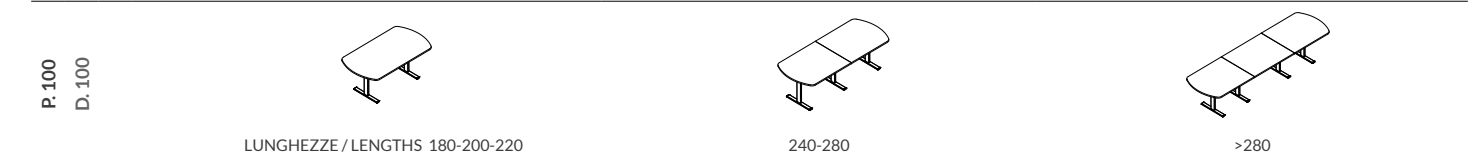

PANEL

Desks

Benches
Call
Meeting



Panel è una linea di arredi direzionali ed operativi, con piani spessore mm 25-30. Disponibili le profondità 60-80-90-100 cm per le scrivanie. Le varie forme e misure ne consentono una ottima flessibilità nella configurazione di ambienti per molteplici esigenze. Poltrone modello Boss.

Panel is a line of executive and operative desks with 25-30 mm thick tops. The available desk depths are 60-80-90-100. The various shapes and sizes allow for an excellent flexibility in the configuration of environments for multiple needs. Boss model chairs.

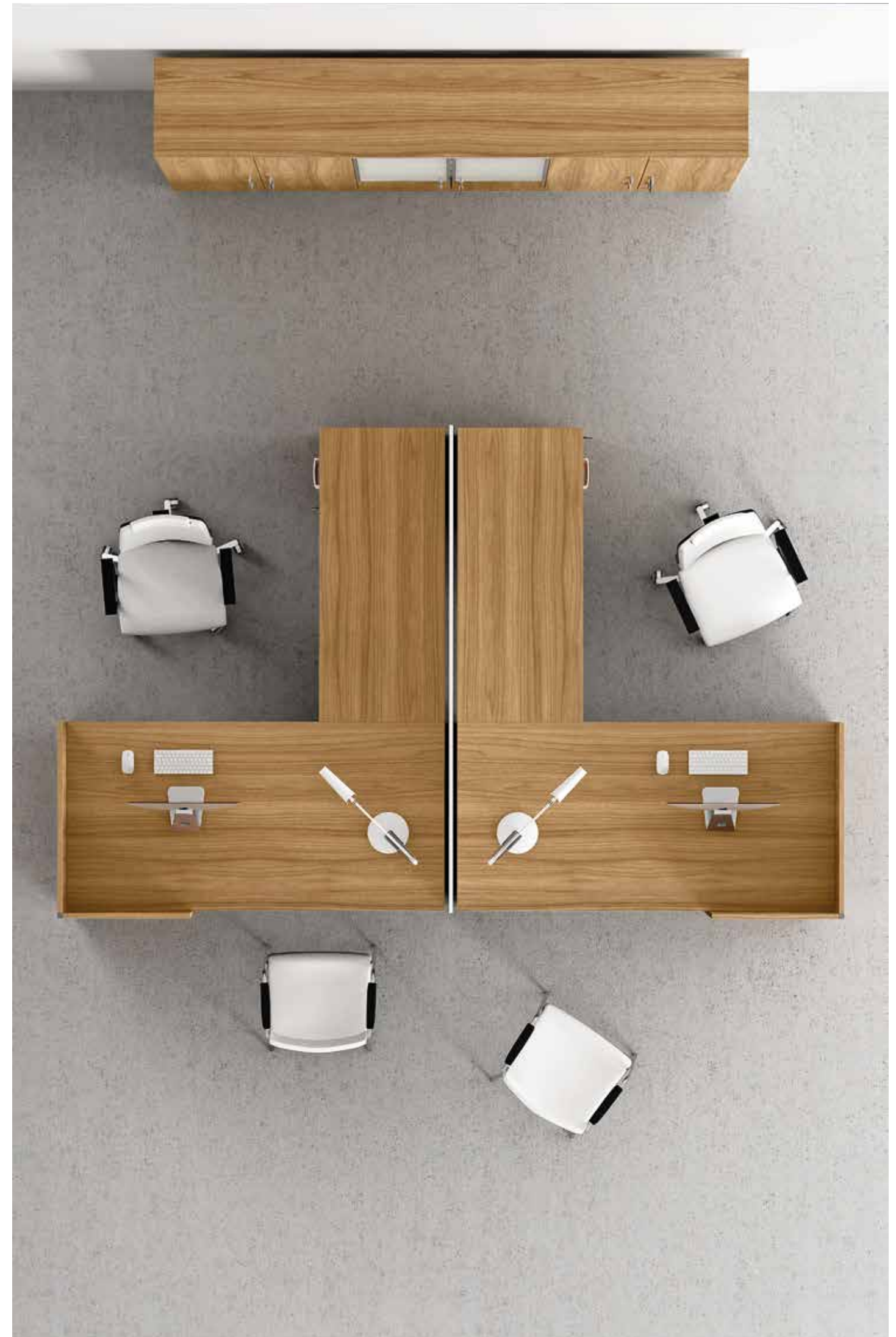



Ambiente con reception. Sedute modello PRIMA. Lampade BQ®.
Reception area, PRIMA model chairs and BQ® lamps.



PANEL

Desks
Benches
Meeting





Configurazione PANEL Benches con sedute MUZIO. Screens e pannelli fonoassorbenti BQ®.
Configurated PANEL benches with MUZIO chairs, BQ® sound absorbing fabric screens and panels.

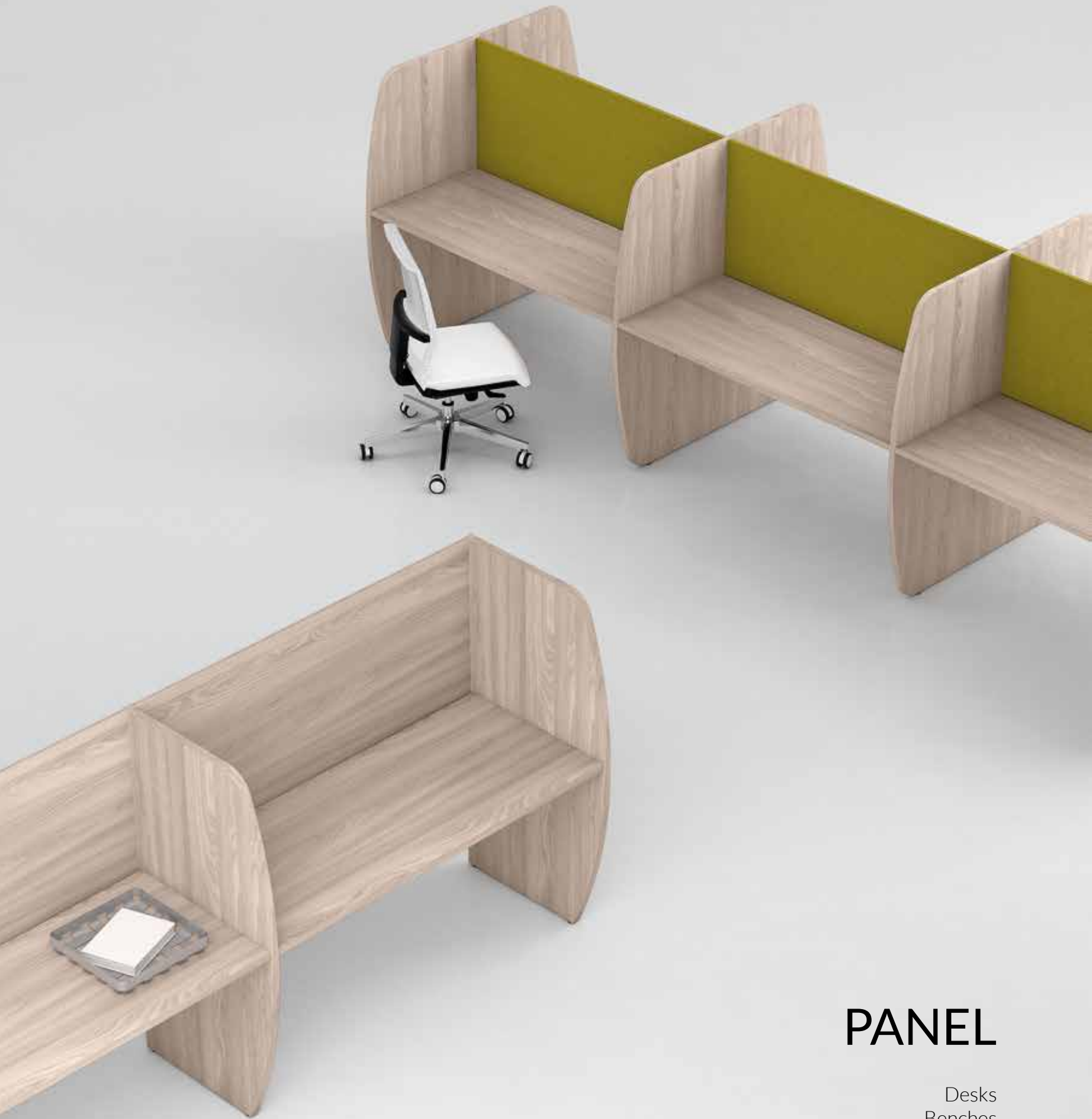

PANEL

Desks
Benches
Call
Meeting





Configurazione PANEL Call con schermi divisori fonoassorbenti. Sedute modello TELA. Lampada e pannelli divisori BQ®.
Configurated PANEL Call with sound absorbing fabric screen dividers, TELA model chairs, BQ® divider screens and lamps.



PANEL

Desk
Benches
Call
Meeting





Tavoli riunione PANEL. Poltroncine modello TREND. Sedie modello SNACK.
PANELmeeting tables with TREND and SNACK model chairs.



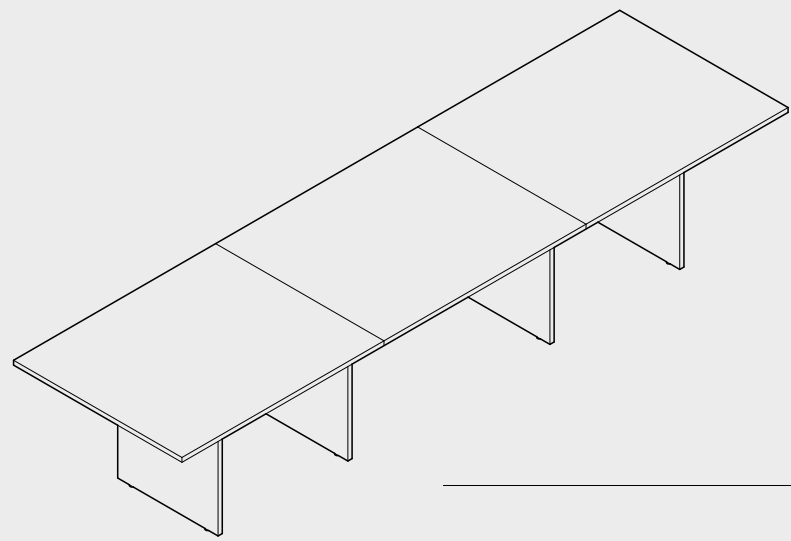

Piani retti pannellati
Straight panelled tops

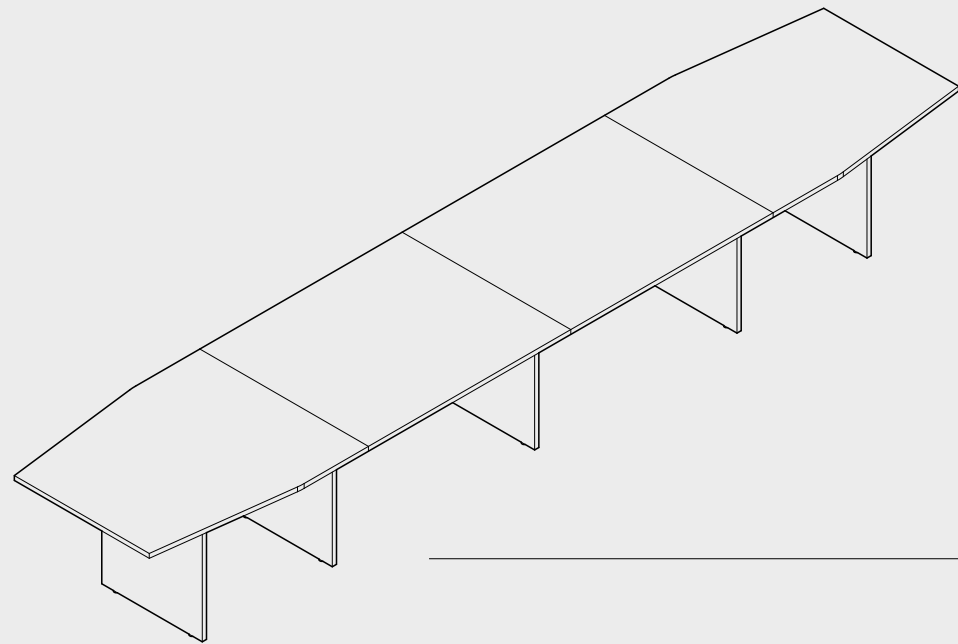

Piani sagomati pannellati
Contoured panelled tops

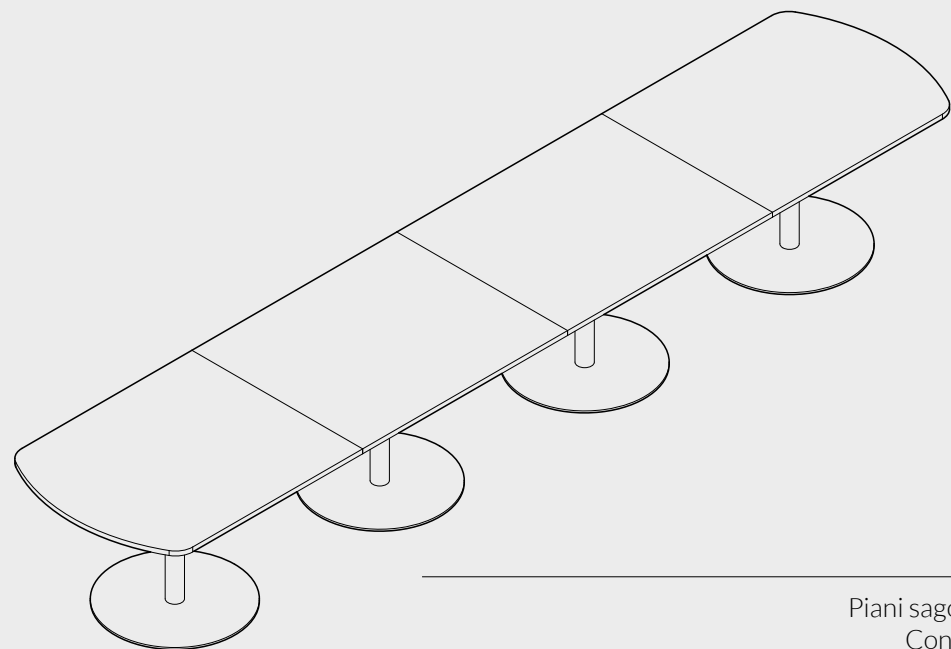

Piani sagomati con gamboni metallici e basi zavorrate
Contoured tops with metal legs and ballast base

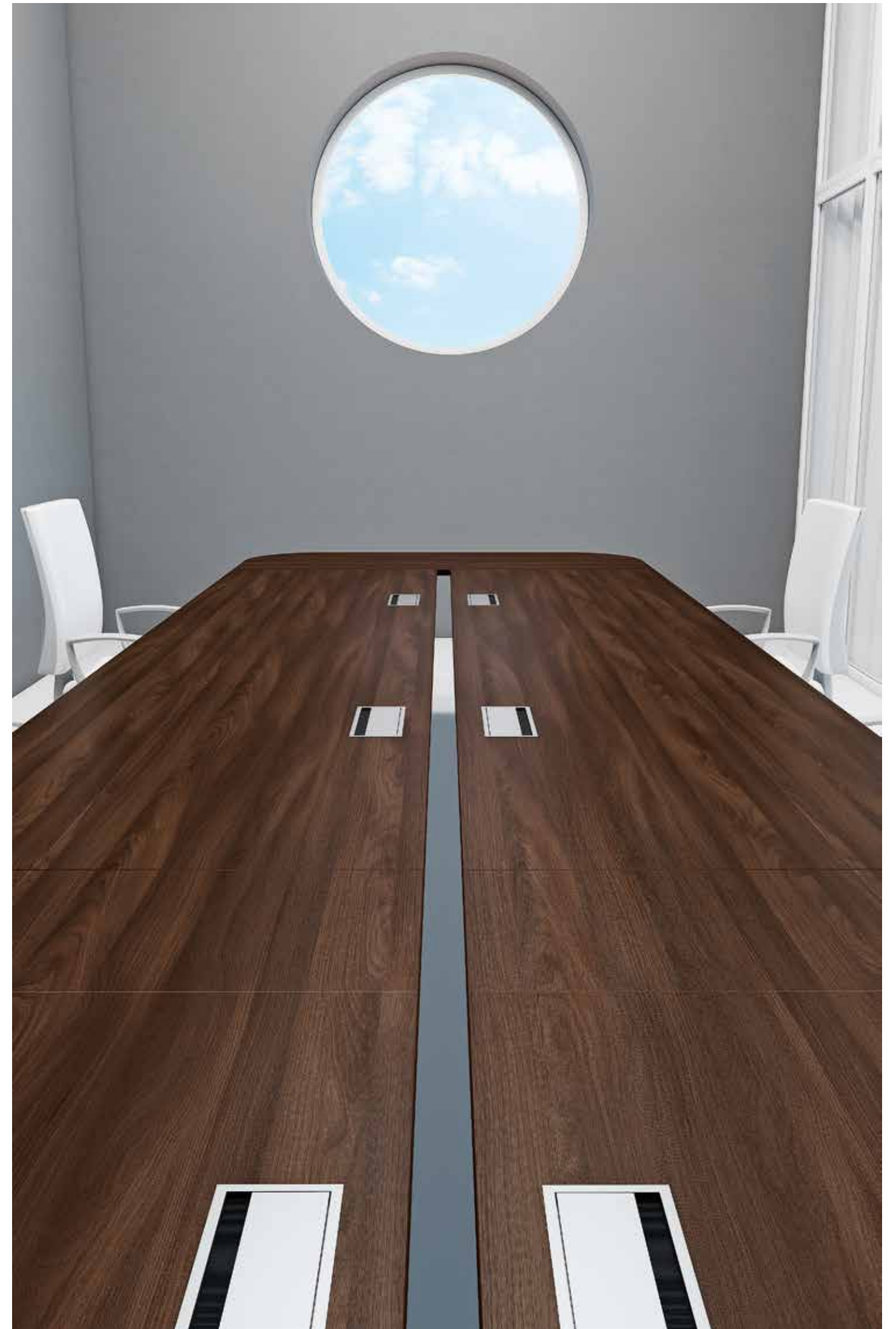

COLORE
COLOUR

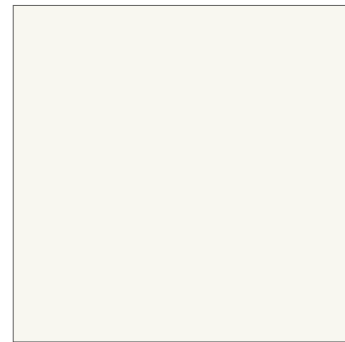

BI
Bianco
White

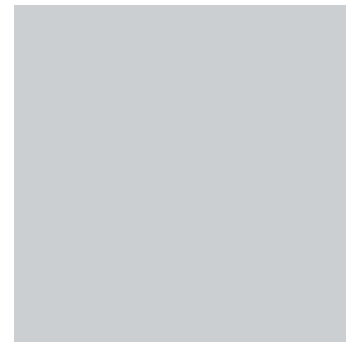

GR
Grigio
Grey



NC
Noce chiaro
Light walnut



NS
Noce scuro
Dark walnut



OC
Olmo chiaro
Light elm



OS
Olmo scuro
Dark elm



RC
Rovere chiaro
Light durmast



RT
Rovere tabacco
Durmast tobacco



NR
Nero
Black

COLORE STRUTTURA
STRUCTURE COLOUR



BI
Bianco
White

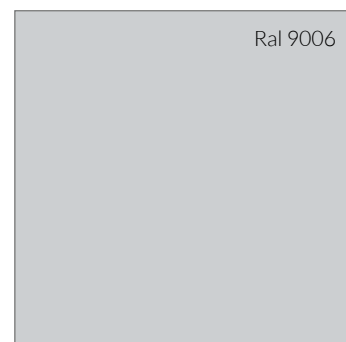

GR
Grigio
Grey

METACRILATO
METHACRYLATE

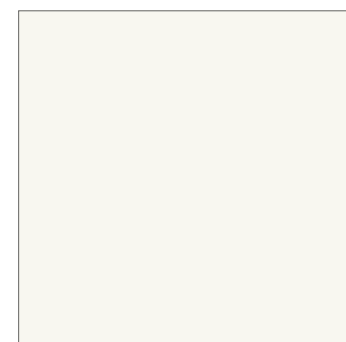

BI
Bianco
White

SPESSORE PIANI
TOPS THICKNESS



25
Piani spessore 25 mm
Top thickness 25 mm



30
Piani spessore 30 mm
Top thickness 30 mm

TESSUTI PER ELEMENTI FONOASSORBENTI
FABRICS FOR SOUND ABSORBING ELEMENTS

Trevira C.S. 100% Poliestere ignifugo
Trevira C.S. 100% Polyester F.R.



629



426



353



358



236



332



354



625



573



356



5501



5502



5551



5451



5452



5201



5202



5301



5601



5552

MANIGLIE HANDLES



MP01.BI
Maniglia in plastica bianca
White plastic handle



MP01.GR
Maniglia in plastica grigia
Grey plastic handle



MZ02.AN
Maniglia in zamac antracite
Anthracite zinc alloy handle



MZ02.GR
Maniglia in zamac grigia
Grey zinc alloy handle



MZ01.GR
Maniglia in zamac grigia
Grey zinc alloy handle



MZ01.BI
Maniglia in zamac bianca
White zinc alloy handle



MA01.SA
Maniglia in alluminio satinato
Satin aluminium handle

ALTRE SPECIFICHE OTHER SPECIFICATIONS



Screen longitudinali e trasversali fonoassorbenti
Longitudinal and cross sound absorbing fabric screens

ELETTRIFICAZIONE ELECTRIFICATION

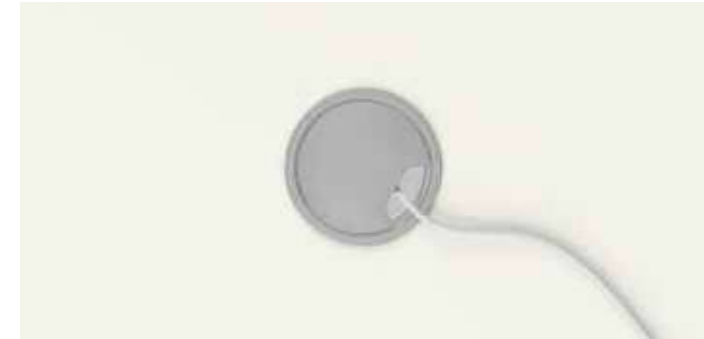

Tappo passacavi
Cable duct cap

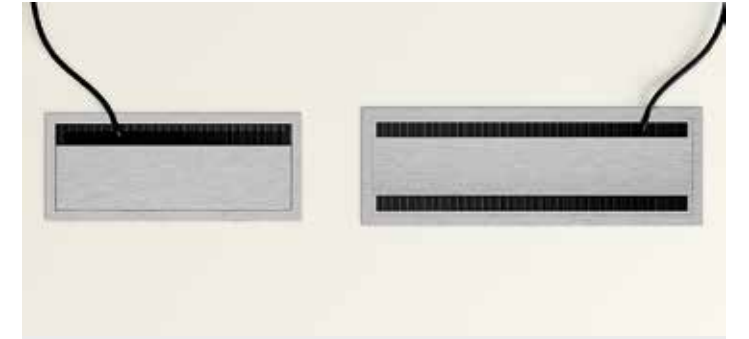

Flap passacavi con apertura singola o doppia
Cable duct flap with single or double opening



Flap con frutti power, dati e USB recharge
Flap with hidden jack, data and USB recharge



Torretta con frutti power, dati e USB recharge
Extractable turret jack, data and USB recharge



Canalina passa cavi orizzontale e verticale
Horizontal and vertical cable duct



Vertebra verticale
Vertical vertebra cable management



Porta PC sospeso e su ruote
Suspended PC case and on wheels

PANEL SYSTEM DESK

ARTICOLI SENZA DISTANZIALE / ITEMS WITHOUT SPACERS

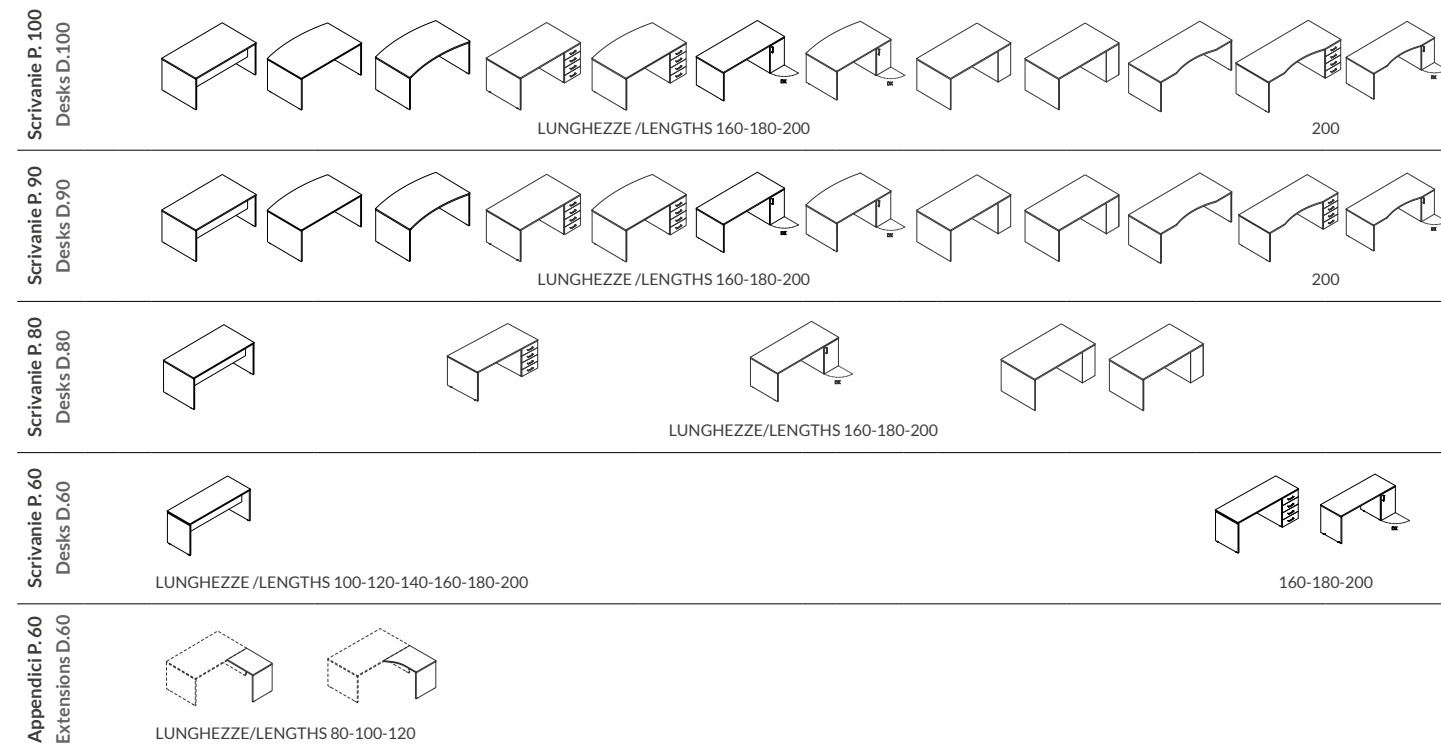

ARTICOLI CON DISTANZIALE / ITEMS WITH SPACERS

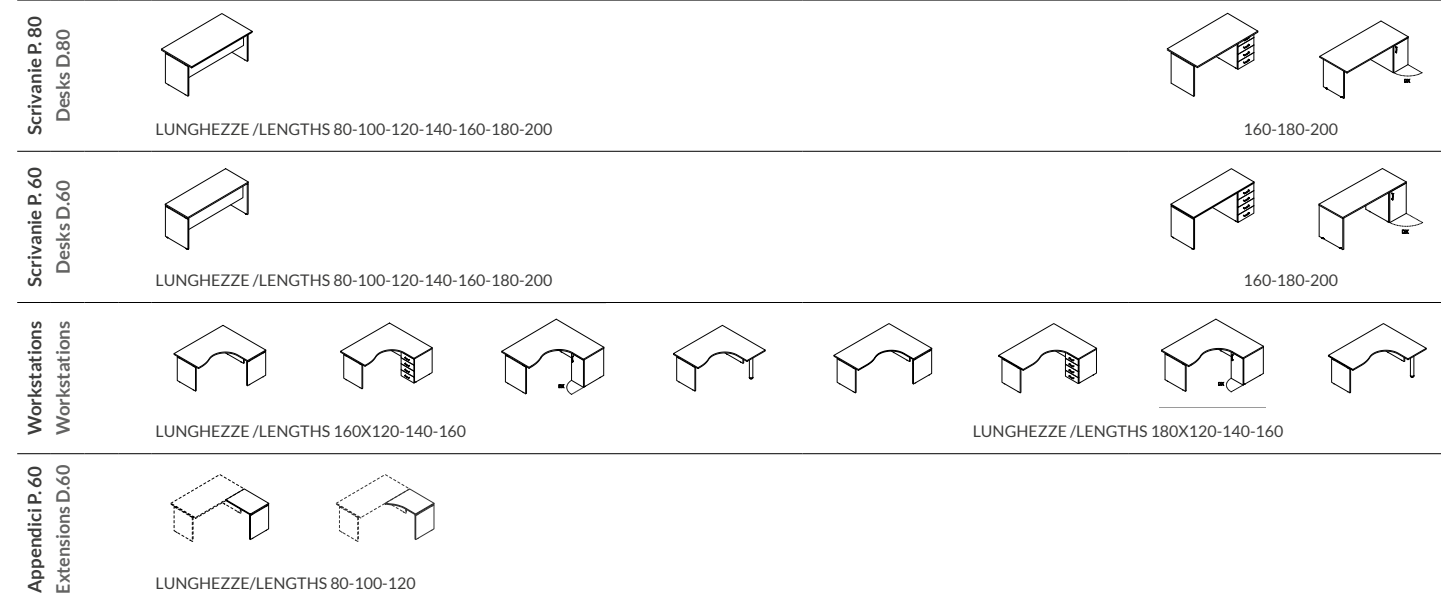

ARTICOLI COMUNI / COMMON ITEMS

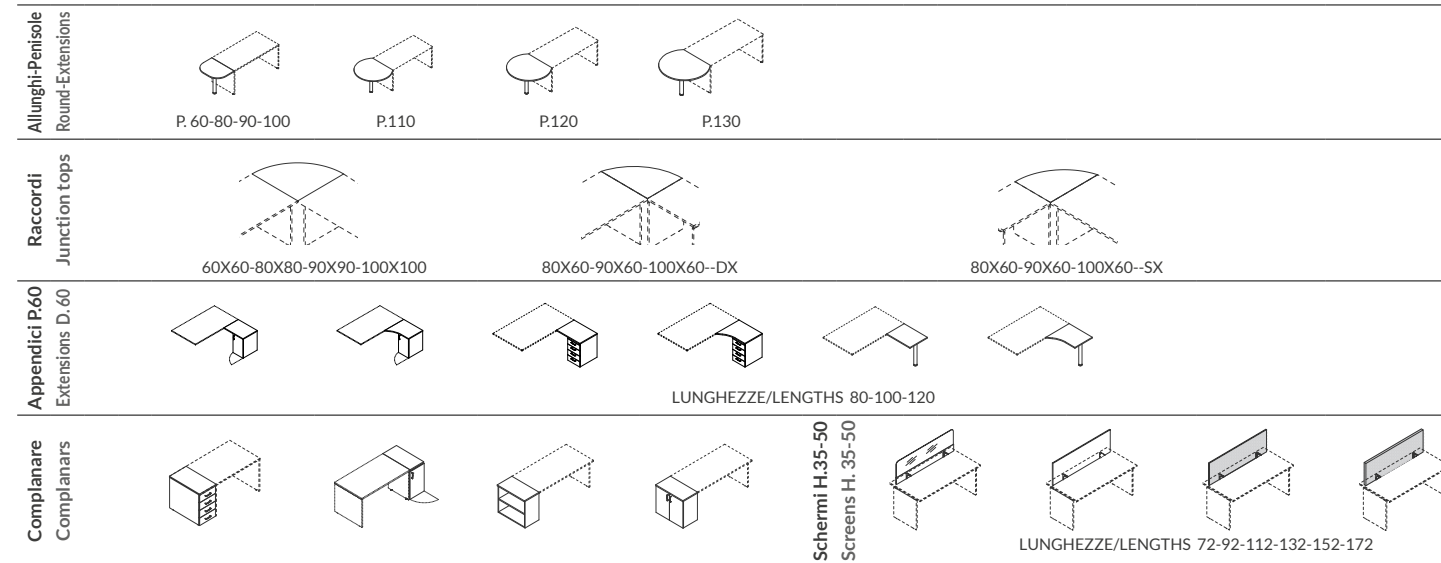

PANEL SYSTEM BENCHES

BENCHES / BENCHE

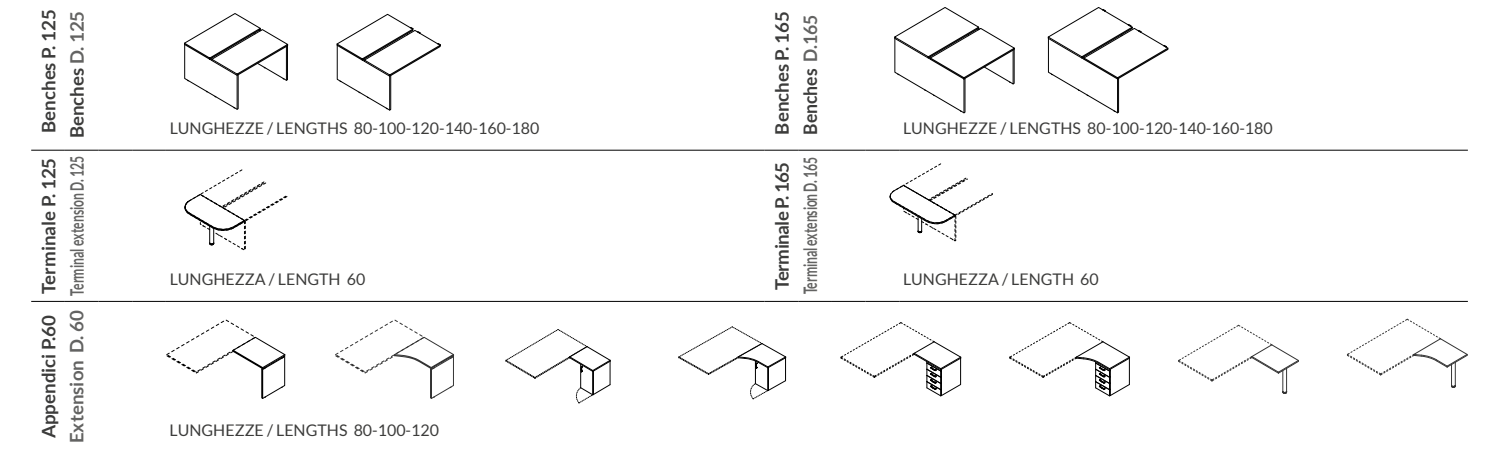

SCHERMI / SCREENS

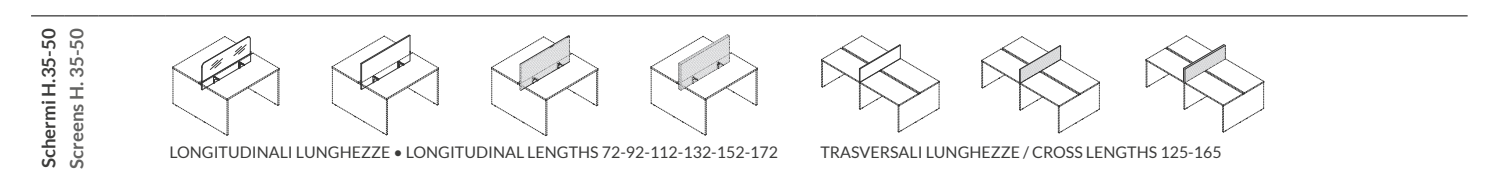

PANEL SYSTEM CALL

CALL IN MELAMINICO / CALL IN MELAMINE

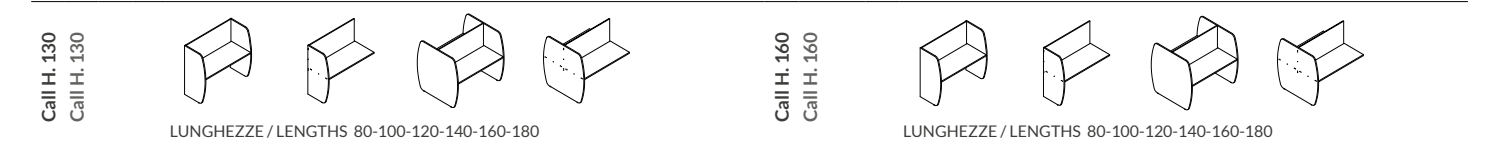

CALL CON FRONTALE FONOASSORBENTE / CALL WITH SOUND ABSORBING FRONT PANEL



PANEL SYSTEM MEETING

TAVOLI RIUNIONE / MEETING TABLES

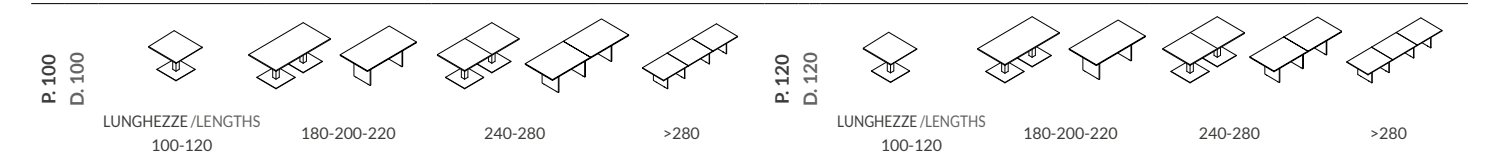

TAVOLI RIUNIONE SAGOMATI / CONTOURED MEETING TABLES

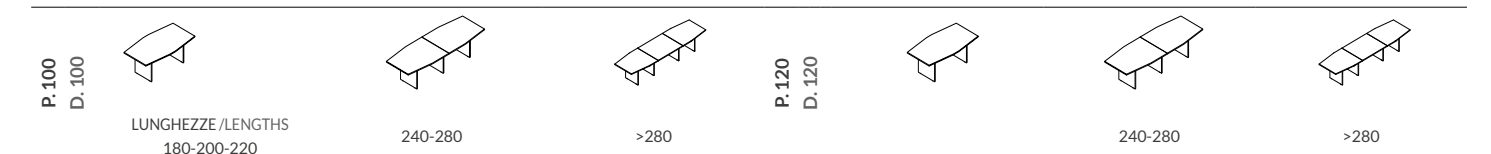

TAVOLI RIUNIONE OVALI / OVAL MEETING TABLES

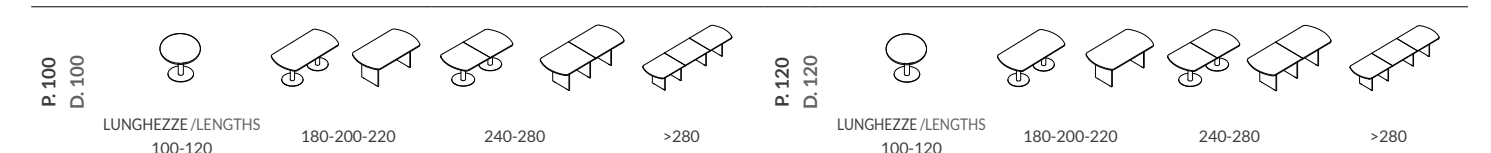

CABINETS

Cabinets standard
Cabinets full
Doors for standard and full
 Cabinets Cube - Lockers
 Drawers



Cabinets è una linea di armadi, disponibili con due profondità (mm 350-450), cinque altezze diverse (mm 795-1179-1563-1947-2331), otto larghezze (mm 300-400-450-500-600-800-900-1000), cinque tipologie di ante diverse (melaminico, melaminico sagomato, fonoassorbente, vetro trasparente, vetro satinato con cornice in alluminio). Nella versione standard i colori disponibili per le casse sono bianco, grigio e nero, con ante disponibili in tutti i colori mentre nella versione full sono disponibili tutti i colori sia per le casse che per le ante.

Cabinets is a line of wardrobes, available in two depths (350-450 mm), five different heights (795-1179-1563-1947-2331 mm) and eight widths (300-400-450-500-600-800-900 -1000 mm). Five types of different doors (Melamine, contoured melamine, sound absorbing, transparent glass, satin glass with aluminium frame). The available colours for the standard version of the box are white, grey and black, with available doors in all colours, whereas, for the full version all colours are available for the box and the doors.





ALTEZZE DISPONIBILI
AVAILABLE HEIGHT SIZES



PROFONDITÀ DISPONIBILI
AVAILABLE DEPTH SIZES



LARGHEZZE DISPONIBILI PER CONTENITORI AD ANTA SINGOLA
AVAILABLE WIDTHS FOR CABINETS WITH A SINGLE DOOR



LARGHEZZE DISPONIBILI PER CONTENITORI AD ANTA DOPPIA
AVAILABLE WIDTHS FOR CABINETS WITH TWO DOORS



ALTEZZE ANTE DI BASE E SOVRAPPOSTE IN MELAMINICO BASE AND OVERLAPPING MELAMINE DOOR HEIGHTS

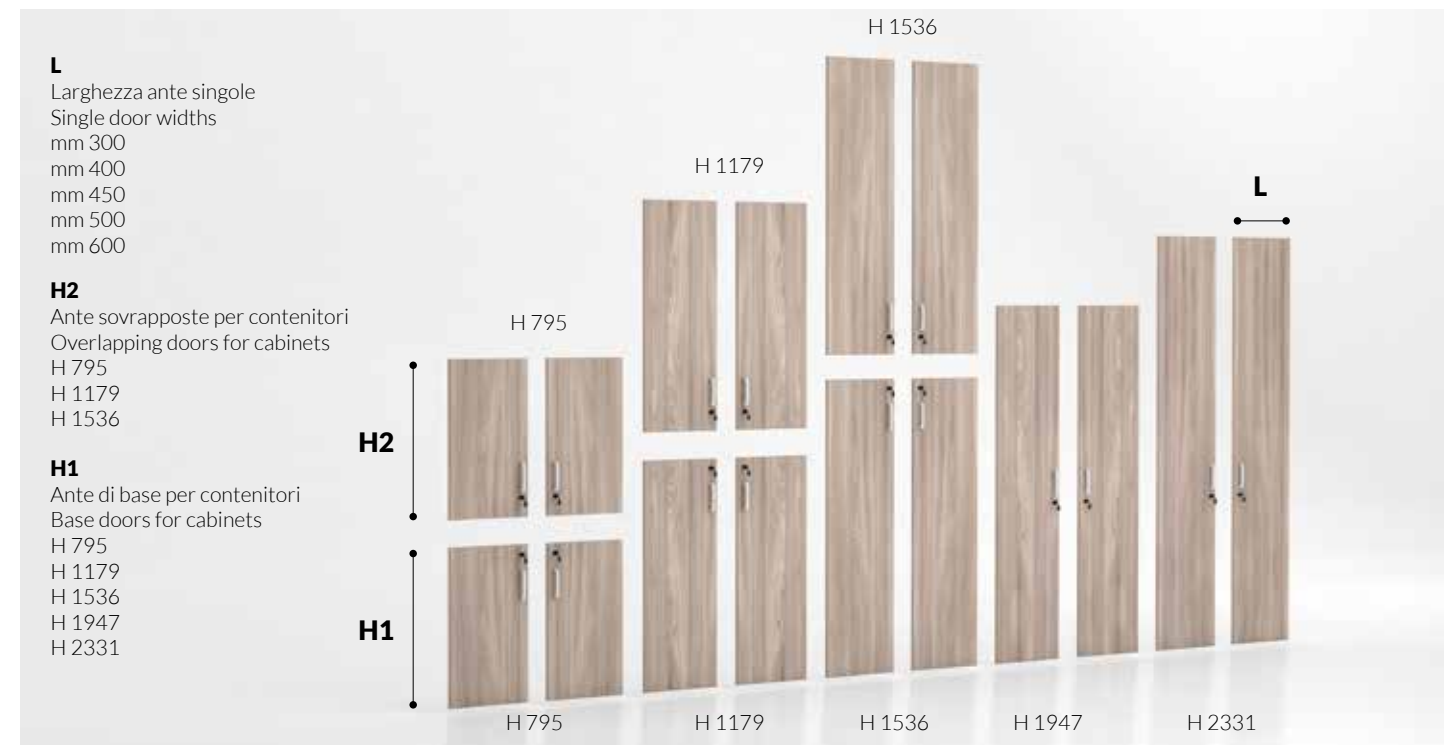

COLORE- COLOUR

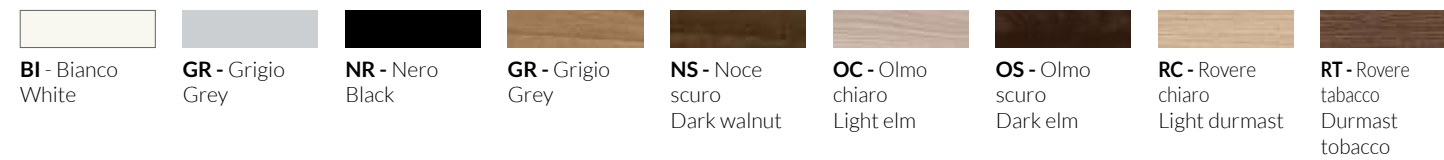

ALTEZZE COPPIE ANTE DI BASE E SOVRAPPOSTE IN MELAMINICO BASE AND OVERLAPPING MELAMINE DOOR PAIR HEIGHTS



COLORE- COLOUR

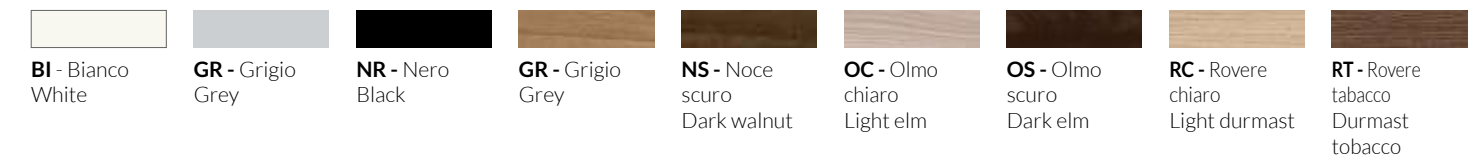

ALTEZZE ANTE DI BASE E SOVRAPPOSTE FONOASSORBENTI BASE AND OVERLAPPING SOUND ABSORBING FABRIC DOOR HEIGHTS

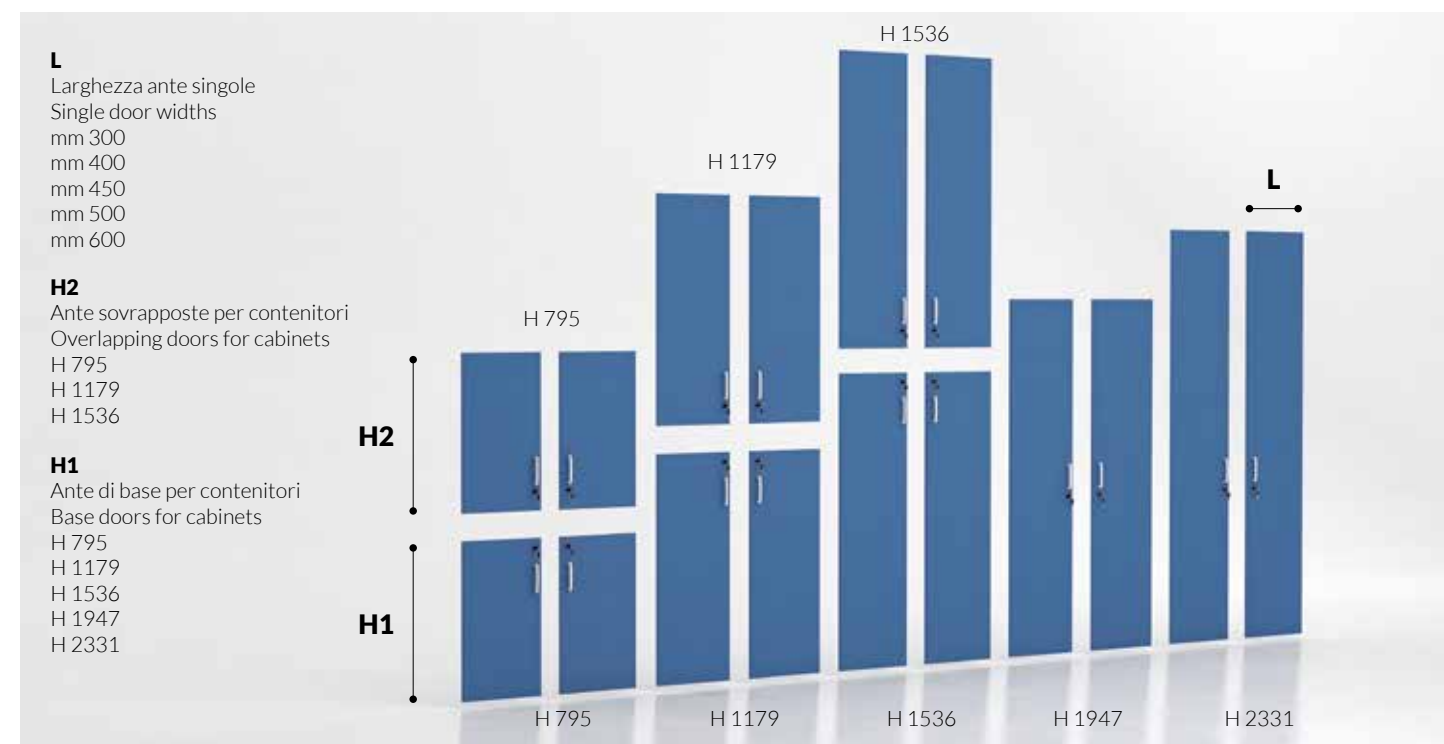

COLORE- COLOUR

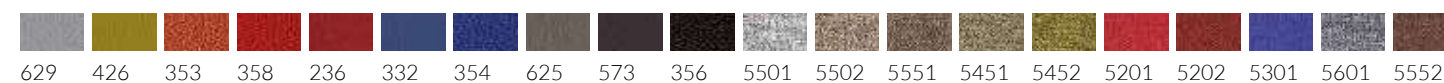

ALTEZZE COPPIE ANTE DI BASE E SOVRAPPOSTE FONOASSORBENTI BASE AND OVERLAPPING SOUND ABSORBING FABRIC DOOR PAIR HEIGHTS

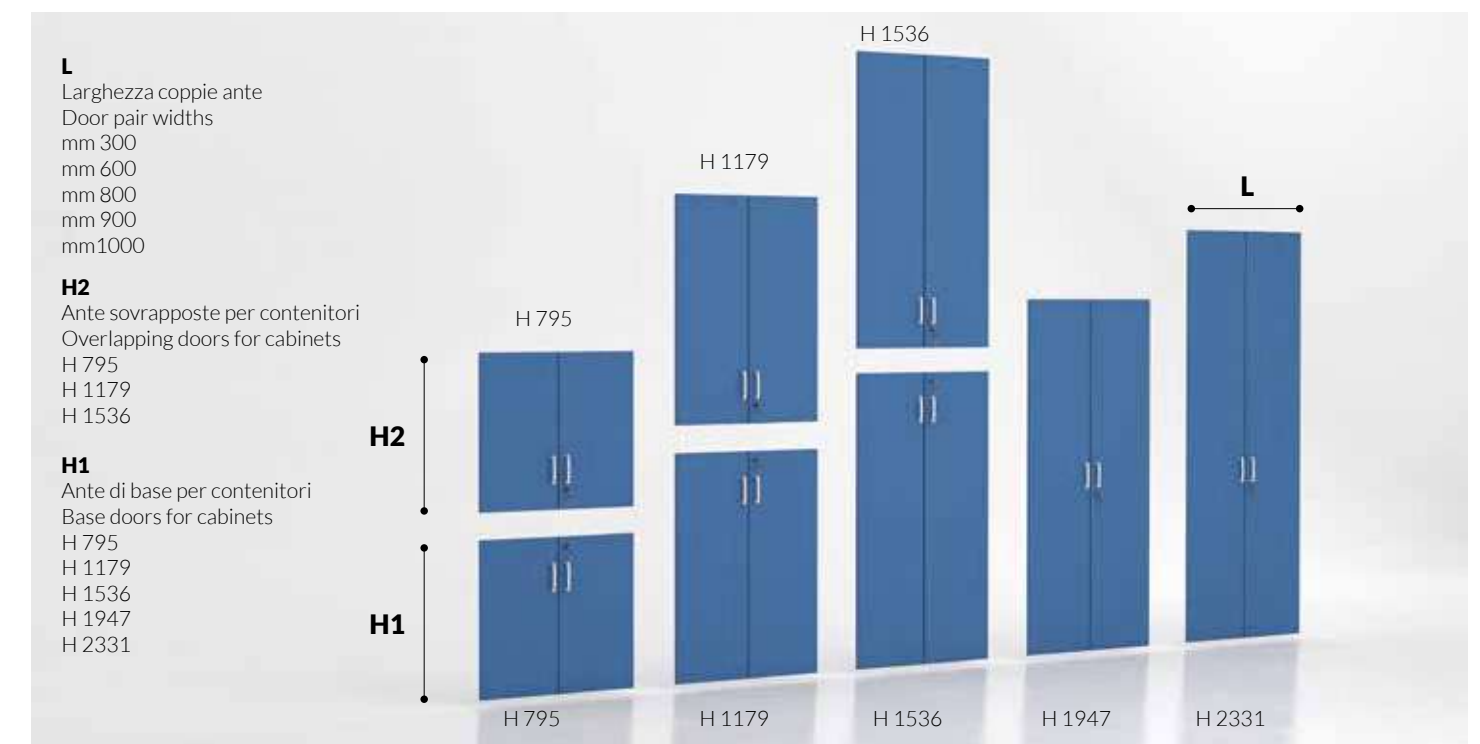

COLORE- COLOUR

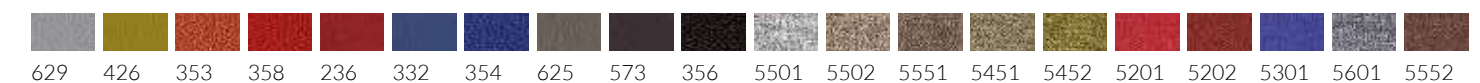

ALTEZZE ANTE DI BASE E SOVRAPPOSTE IN VETRO TRASPARENTE
BASE AND OVERLAPPING TRANSPARENT GLASS DOOR HEIGHTS

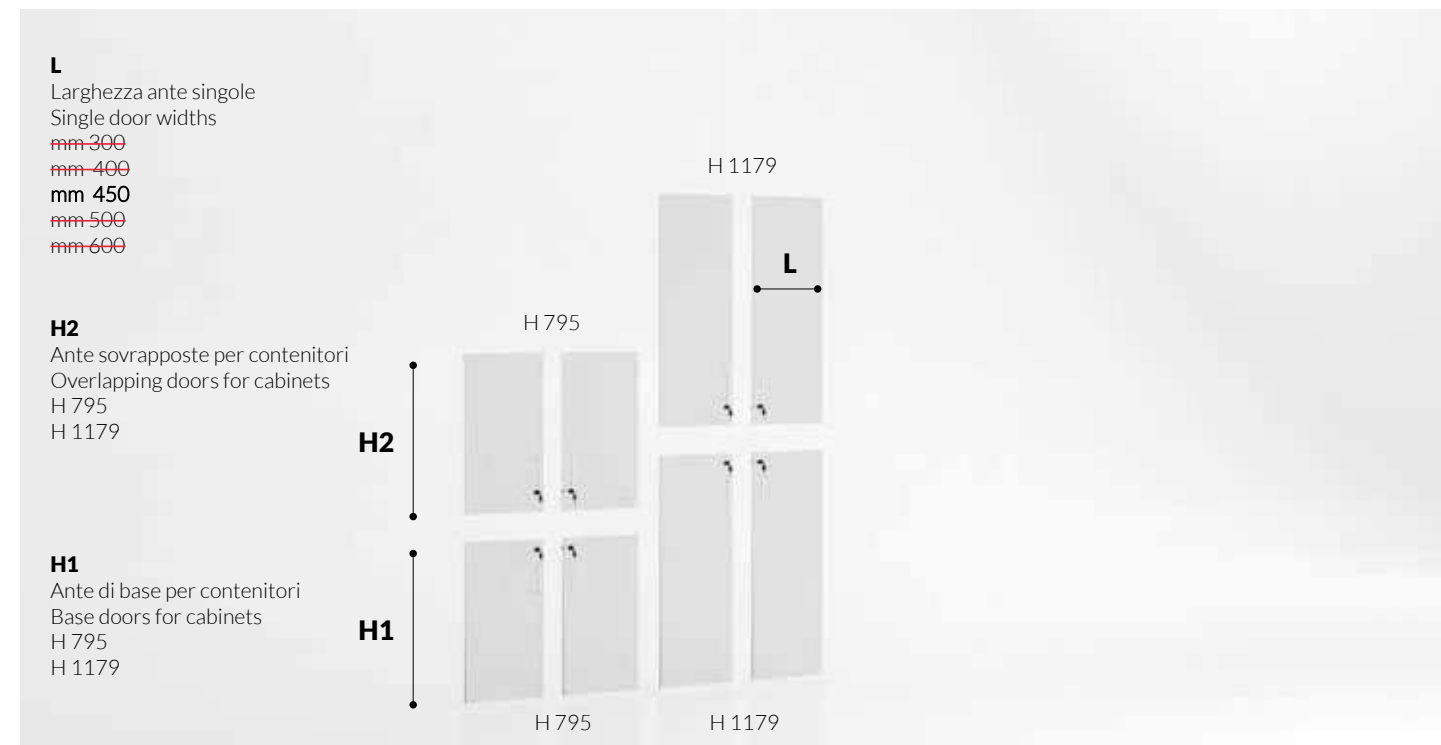

COLORE- COLOUR



VT - Vetro trasparente
 Transparent glass

ALTEZZE COPPIE ANTE DI BASE E SOVRAPPOSTE IN VETRO TRASPARENTE
BASE AND OVERLAPPING TRANSPARENT GLASS DOOR PAIR HEIGHTS

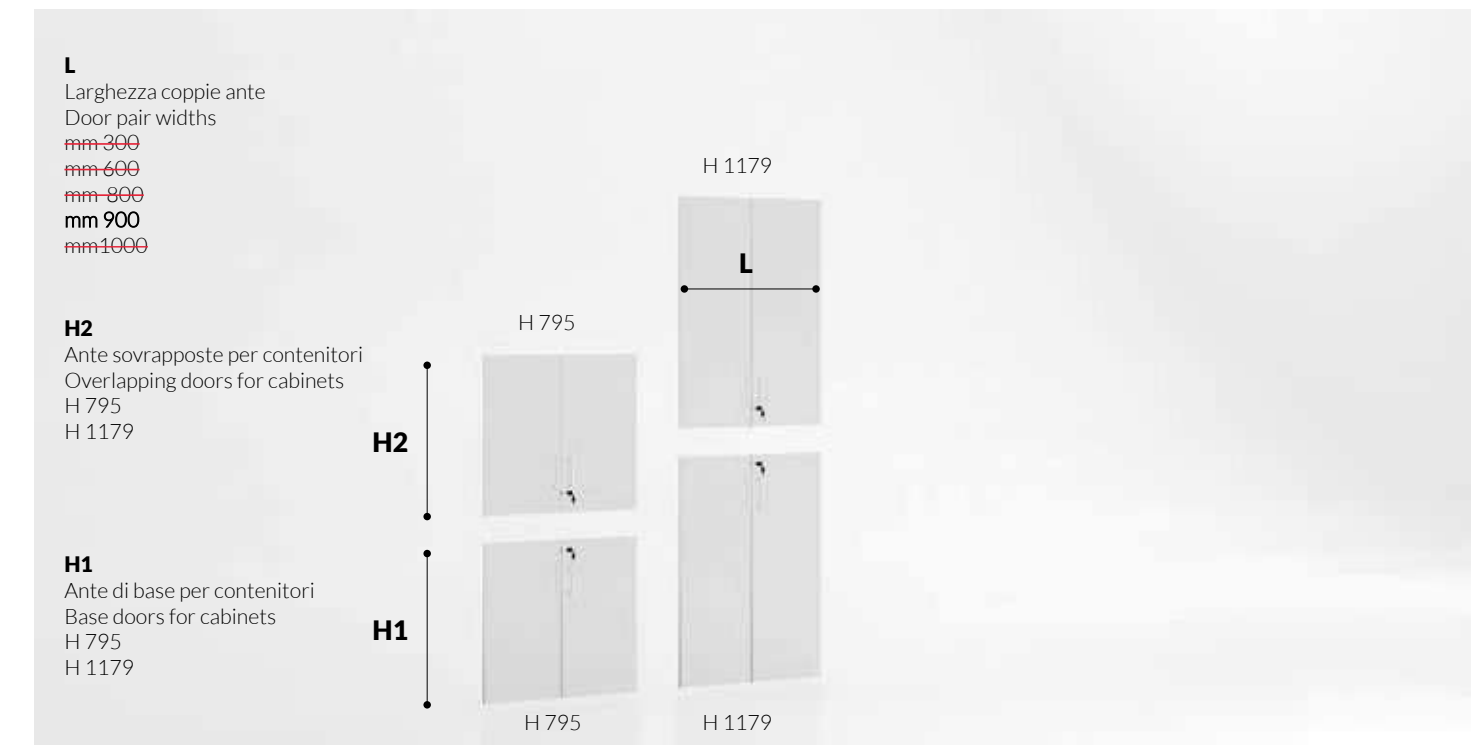

COLORE- COLOUR



VT - Vetro trasparente
 Transparent glass

ALTEZZE ANTE DI BASE E SOVRAPPOSTE IN VETRO ACIDATO CON TELAIO ALLUMINIO
BASE AND OVERLAPPING ETCHED GLASS DOOR HEIGHTS WITH ALUMINIUM FRAME

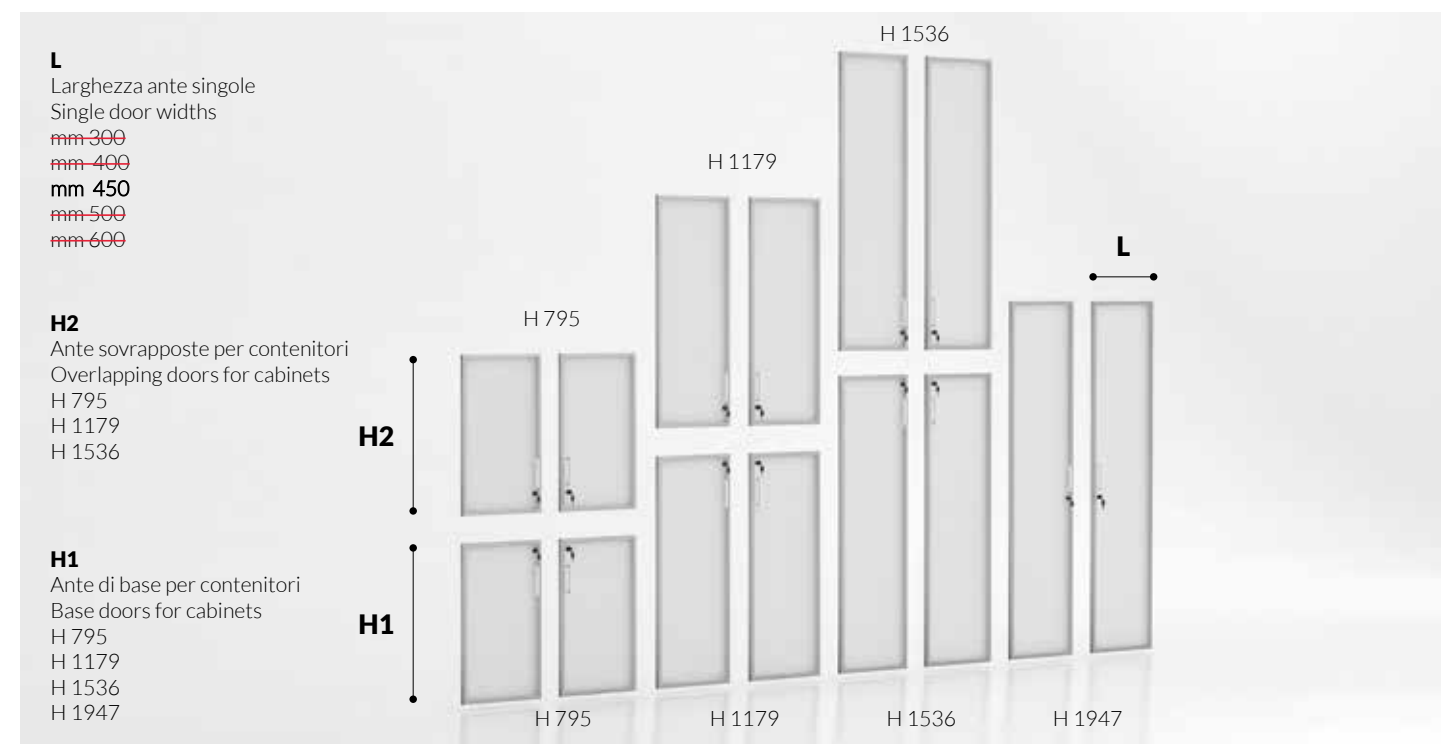

COLORE- COLOUR

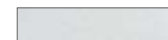

VTA - Vetro acidato con cornice in alluminio
 Etched glass with aluminium frame

ALTEZZE COPPIE ANTE DI BASE E SOVRAPPOSTE IN VETRO ACIDATO CON TELAIO ALLUMINIO
BASE AND OVERLAPPING ETCHED GLASS DOOR PAIR HEIGHTS WITH ALUMINIUM FRAME

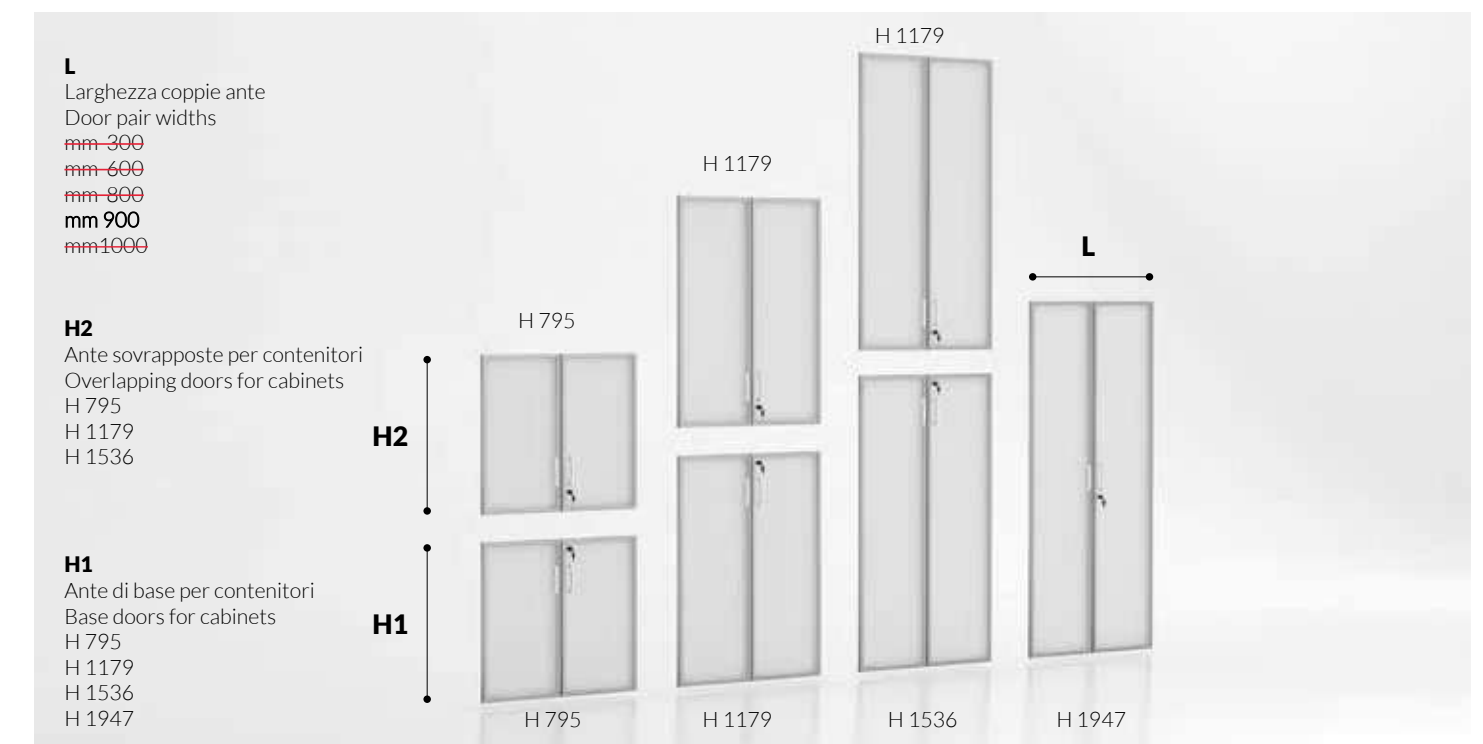

COLORE- COLOUR

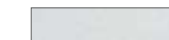

VTA - Vetro acidato con cornice in alluminio
 Etched glass with aluminium frame

ALTEZZE ANTE DI BASE E SOVRAPPOSTE IN MELAMINICO SAGOMATE
BASE AND OVERLAPPING CONTOURED MELAMINE DOOR HEIGHTS

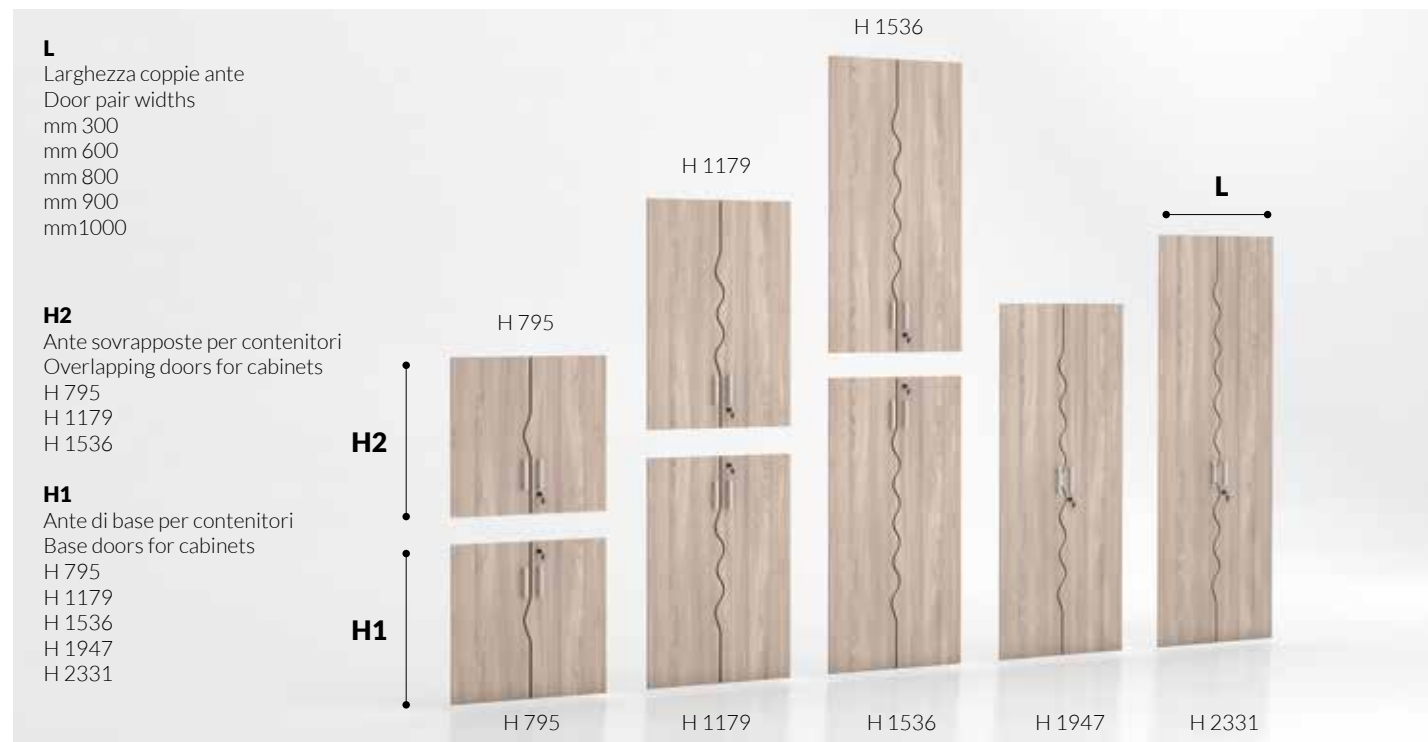

COLORE - COLOUR

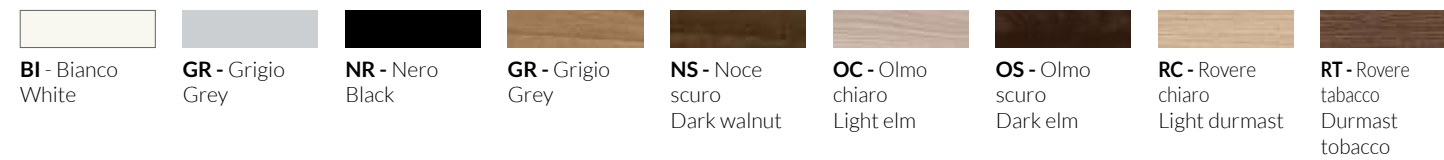

MANIGLIE
HANDLES

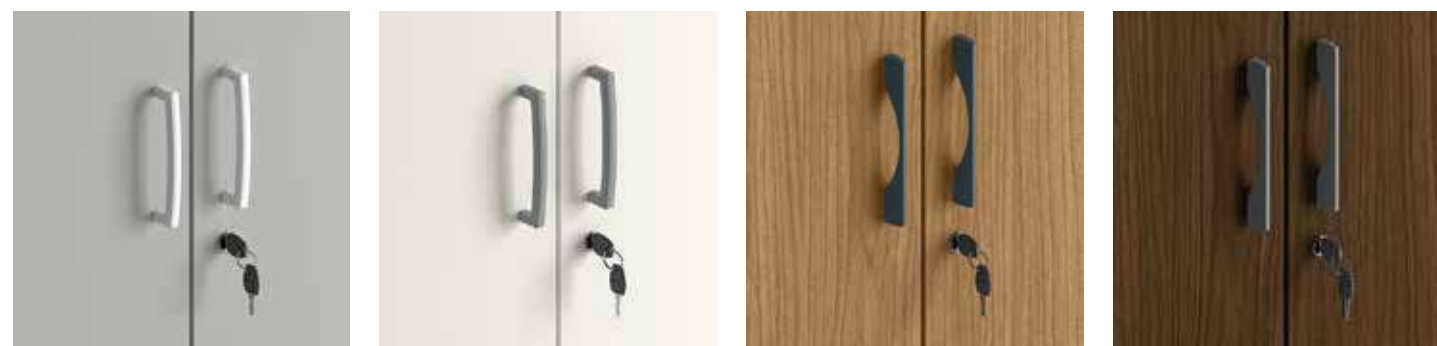

MP01.BI
Maniglia in plastica bianca
White plastic handle

MP01.GR
Maniglia in plastica grigia
Grey plastic handle

MZ02.AN
Maniglia in zamac antracite
Anthracite zinc alloy handle

MZ02.GR
Maniglia in zamac grigia
Grey zinc alloy handle



MZ01.GR
Maniglia in zamac grigia
Grey zinc alloy handle



MZ01.BI
Maniglia in zamac bianca
White zinc alloy handle

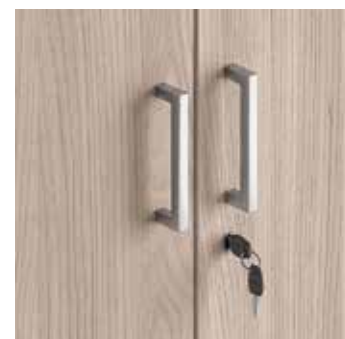

MA01.SA
Maniglia in alluminio satinato
Satin aluminium handle

TOP - FIANCHI - SCHIENE OPZIONALI
TOPS-SIDES-OPTIONAL BACKS

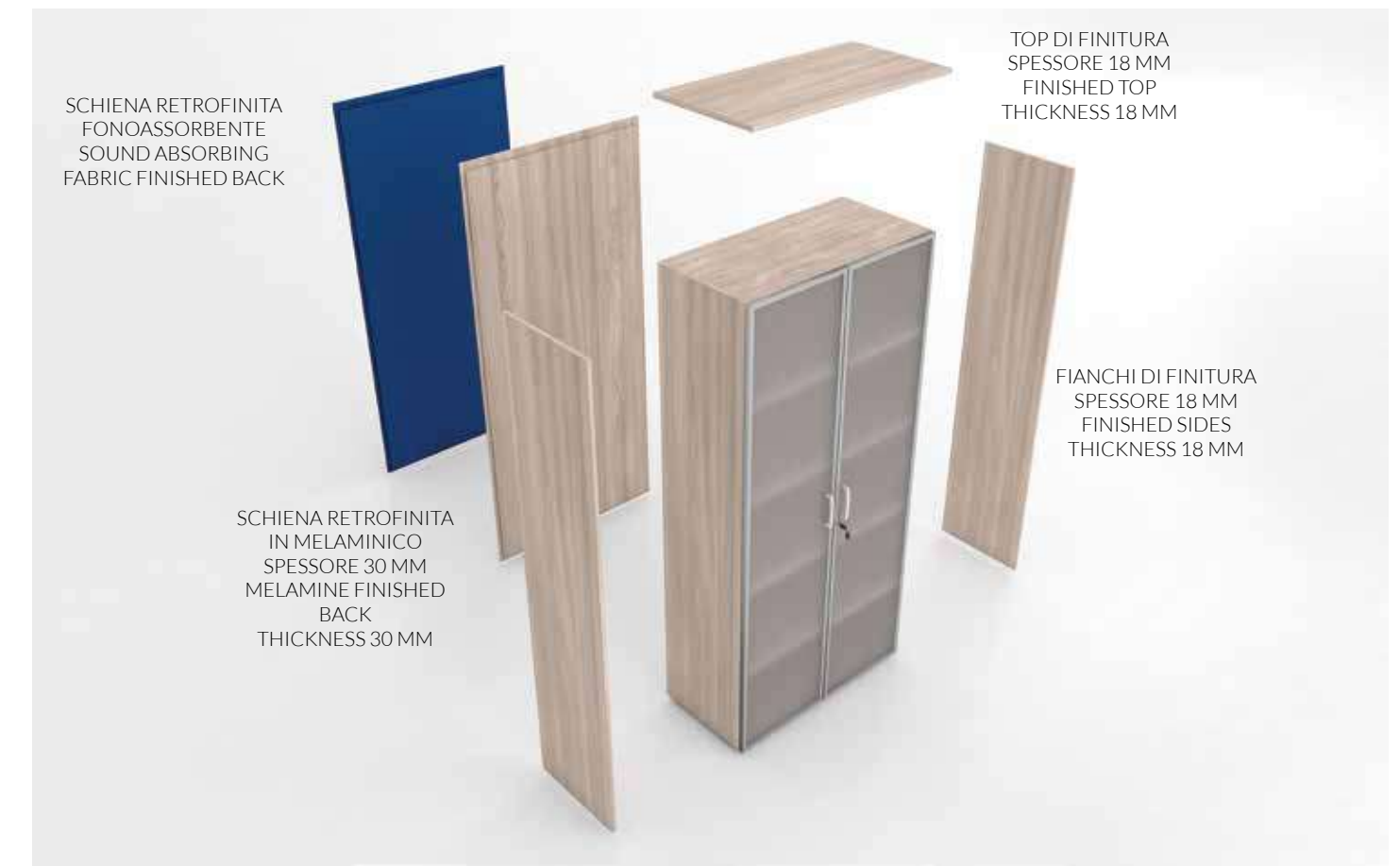

Ripiani metallici opzionali
Optional metal shelves



Serratura di serie con chiave
Series lock with key



Zoccolo opzionale
Optional plinth



Serratura a cariglione opzionale
Optional guided lock

CABINETS CUBE

Cabinet standard
Cabinet full
Doors for standard and full
Cabinet Cube - Lockers
Drawers



Cabinets Cube è una linea di armadi, disponibili con due profondità (mm 350-450), quattro altezze diverse (mm 795-1179-1563-1947), e una larghezza mm 450. Ante con push and pull, con serratura o con combinazione meccanica. Nella versione standard i colori disponibili per le casse sono bianco, grigio e nero, con ante disponibili in tutti i colori mentre nella versione full sono disponibili tutti i colori sia per le casse che per ante.









Cabinets cube is a line of wardrobes, available in two depths (350-450 mm), four different heights (795-1179-1563-1947 mm), 450 mm wide. Doors with push and pull, with lock or with mechanical combination. The available colours for the standard version of the box are white, grey and black, with available doors in all colours, whereas, for the full version all colours are available for the box and the doors.





Due profondità disponibili mm. 350 e mm. 450.
Two available depths mm.350 and mm. 450.

COLORE- COLOUR

								
BI - Bianco White	GR - Grigio Grey	NR - Nero Black	GR - Grigio Grey	NS - Noce scuro Dark walnut	OC - Olmo chiaro Light elm	OS - Olmo scuro Dark elm	RC - Rovere chiaro Light durmast	RT - Rovere tabacco Durmast tobacco

CABINETS CUBE LOCKERS



* Le dimensioni indicate comprendono lo spessore del top
*The indicated dimensions include the thickness of the top

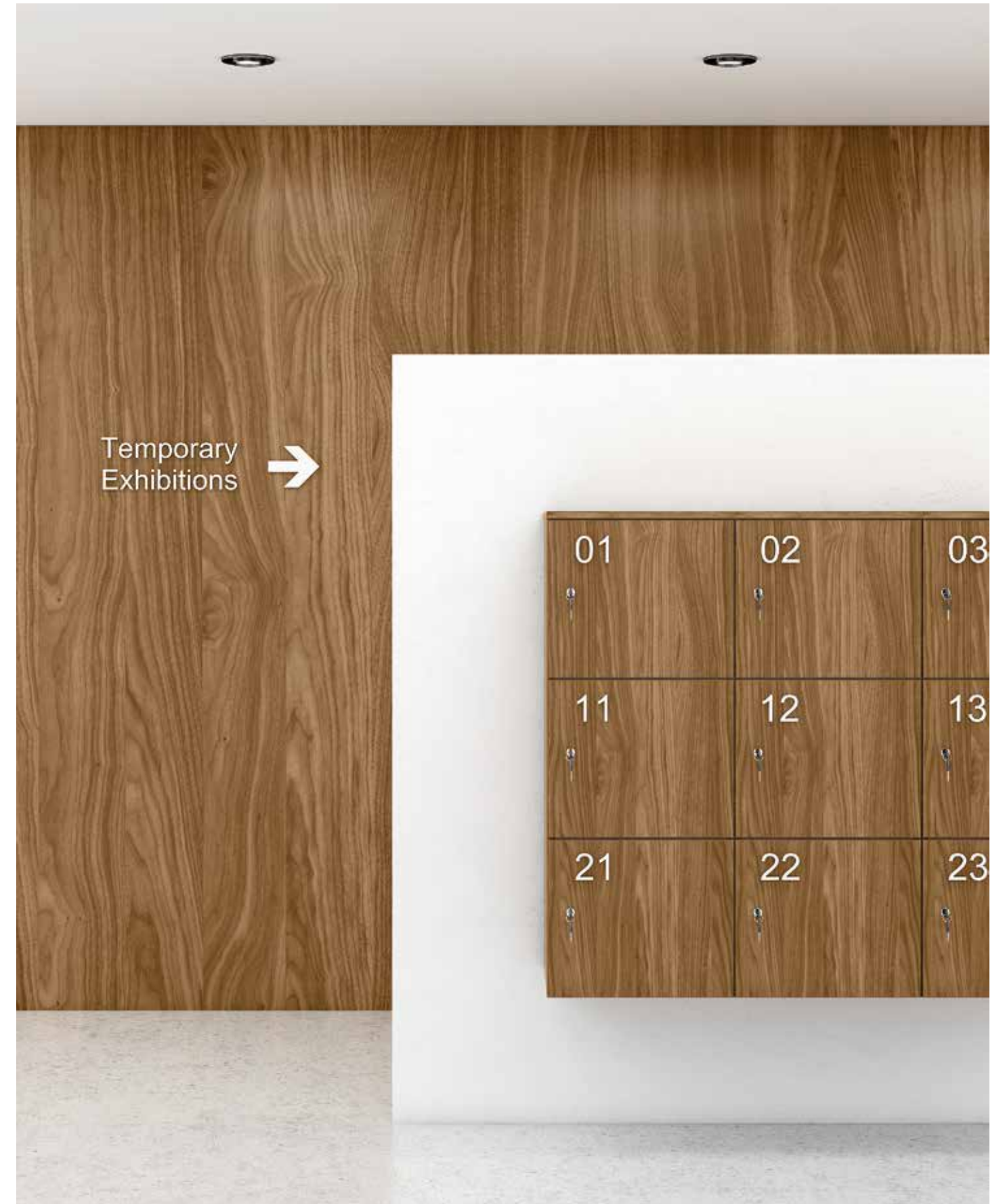

Chiusura a leva con chiave.
Lock lever with key.



Chiusura meccanica con combinazione.
Mechanical lock with combination.



Chiusura push and pull.
Push and pull closure.

DRAWERS

Cabinet standard
 Cabinet full
 Doors for standard and full
 Cabinet Cube - Lockers
Drawers



Cassettiere su ruote disponibili a due, tre e quattro cassetti, nelle larghezze mm 340-420. Mobili di servizio su ruote configurabili in diverse larghezze con gli elementi a giorno con ante o cassettiere. Possibilità di corredarli con cuscini sul top. Nella versione standard i colori disponibili per le casse sono bianco, grigio e nero, con frontali e top disponibili in tutti i colori mentre nella versione full sono disponibili tutti i colori sia per le casse che per frontali e top.

Drawer units on wheels available with two, three and four drawers, in widths of 340-420 mm. Configurable service units on wheels in different widths with at sight elements with doors or drawers. It is possible to accompany them with cushions on top. The available colours for the standard version of the box are white, grey and black, with available fronts and top in all colours, whereas, for the full version all colours are available for the box, fronts and top.



VERSIONE STANDARD

I colori disponibili per le casse sono bianco, grigio e nero, con frontali e top disponibili in tutti i colori.

STANDARD VERSION

The available colours for the box are white, grey and black with fronts and top in all colours.

**VERSIONE FULL**

Sono disponibili tutti i colori sia per le casse che per frontali e top.

FULL VERSION

All colours are available for the box, fronts and top.



COLORE
COLOUR

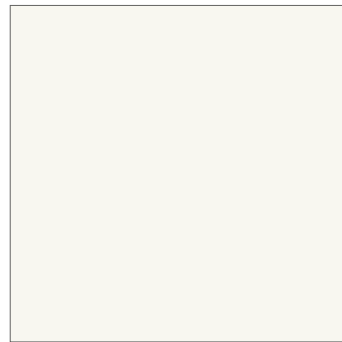

BI
Bianco
White

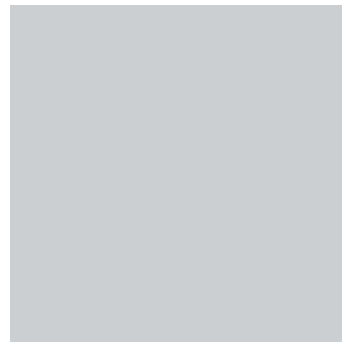

GR
Grigio
Grey



NR
Nero
Black



NC
Noce chiaro
Light walnut



NS
Noce scuro
Dark walnut



OC
Olmo chiaro
Light elm



OS
Olmo scuro
Dark elm



RC
Rovere chiaro
Light durmast



RT
Rovere tabacco
Durmast tobacco

COLORE STRUTTURA
STRUCTURE COLOUR



BI
Bianco
White

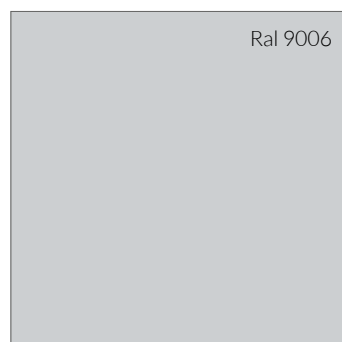

GR
Grigio
Grey

MANIGLIE
HANDLES



MP01.BI
Maniglia in plastica bianca
White plastic handle



MP01.GR
Maniglia in plastica grigia
Grey plastic handle



MZ02.AN
Maniglia in zamac antracite
Anthracite zinc alloy handle



MZ02.GR
Maniglia in zamac grigia
Grey zinc alloy handle



MZ01.GR
Maniglia in zamac grigia
Grey zinc alloy handle



MZ01.BI
Maniglia in zamac bianca
White zinc alloy handle



MA01.SA
Maniglia in alluminio satinato
Satin aluminium handle

TESSUTI PER CUSCINI
FABRICS FOR CUSHIONS

Trevira C.S. 100% Poliestere ignifugo
Trevira C.S. 100% Polyester F.R.



629



426



353



358



236



332



354



625



573



356



5501



5502



5551



5451



5452



5201



5202



5301



5601



5552

CONTENITORI CABINETS

CONTENITORI P. 35-45 / CABINETS D. 35-45

Contenitori H. 79,5 Cabinets H. 79,5		LUNGHEZZE / LENGTHS 30-40-45-50-60		LUNGHEZZE / LENGTHS 45
Contenitori H. 79,5 Cabinets H. 79,5		LUNGHEZZE / LENGTHS 60-80-90-100		LUNGHEZZE / LENGTHS 90
Contenitori H. 117,9 Cabinets H. 117,9		LUNGHEZZE / LENGTHS 30-40-45-50-60		LUNGHEZZE / LENGTHS 45
Contenitori H. 117,9 Cabinets H. 117,9		LUNGHEZZE / LENGTHS 60-80-90-100		LUNGHEZZE / LENGTHS 90
Contenitori H. 156,3 Cabinets H. 156,3		LUNGHEZZE / LENGTHS 30-40-45-50-60		LUNGHEZZE / LENGTHS 45
Contenitori H. 156,3 Cabinets H. 156,3		LUNGHEZZE / LENGTHS 60-80-90-100		LUNGHEZZE / LENGTHS 90
Contenitori H. 194,7 Cabinets H. 194,7		LUNGHEZZE / LENGTHS 30-40-45-50-60		LUNGHEZZE / LENGTHS 45
Contenitori H. 194,7 Cabinets H. 194,7		LUNGHEZZE / LENGTHS 60-80-90-100		LUNGHEZZE / LENGTHS 90
Contenitori H. 233,1 Cabinets H. 233,1		LUNGHEZZE / LENGTHS 30-40-45-50-60		LUNGHEZZE / LENGTHS 45
Contenitori H. 233,1 Cabinets H. 233,1		LUNGHEZZE / LENGTHS 60-80-90-100		LUNGHEZZE / LENGTHS 90

Tops
Tops

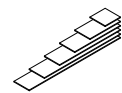

LUNGHEZZE / LENGTHS 45-90-135-180-235-270

Fianchi
Sides

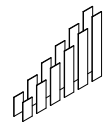

LUNGHEZZE / LENGTHS 79,5-117,9-156,3-194,7-233,1

CABINET CUBE CABINET CUBE

Elementi H. 118
Elements D. 118



COMPOSIZIONI / COMPOSITIONS

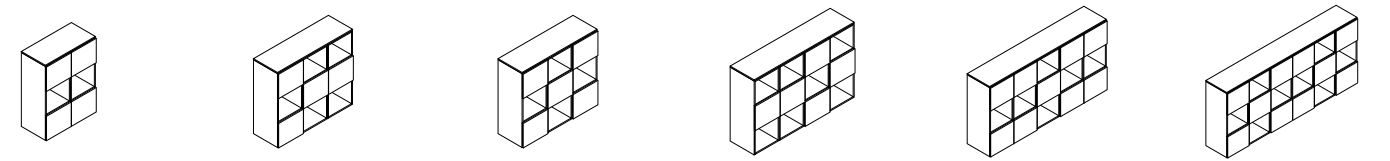

LOCKERS

Chiusura a leva con chiave
Lock lever with key

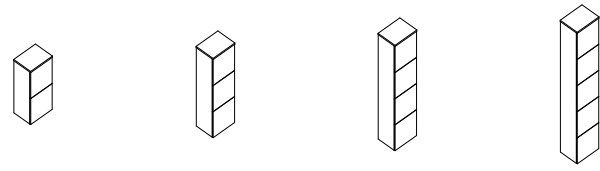

Chiusura meccanica con combinazione
Mechanical lock with combination

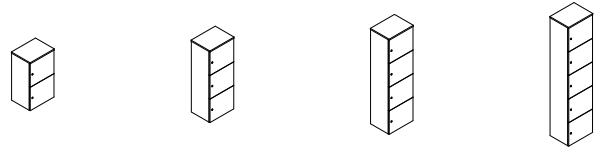

Chiusura push and pull
Push and pull closure

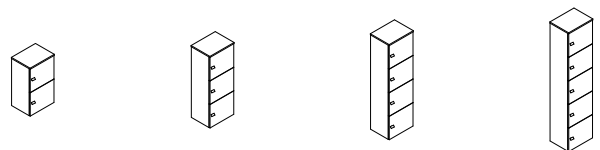

COMPOSIZIONI / COMPOSITIONS

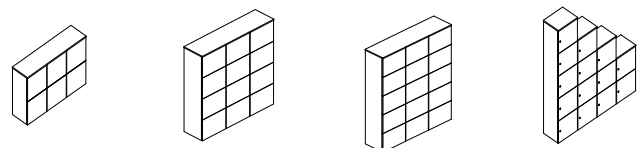

DRAWERS

CASSETTIERE SU RUOTE / CHEST OF DRAWERS ON WHEELS

L. 34
L.34



L. 42
L. 42

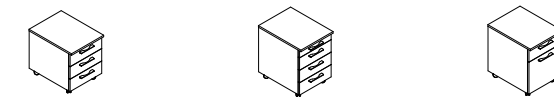

Metalliche
Metal



MOBILI DI SERVIZIO SU RUOTE / CABINET UNIT ON WHEELS

Due scomparti
Two compartments

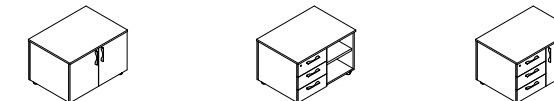

LUNGHEZZA / LENGTH 84

Tre scomparti
Three compartments

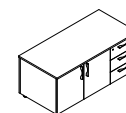

LUNGHEZZA / LENGTH 126

CUSCINI / CUSHIONS

Cuscini
Cushions

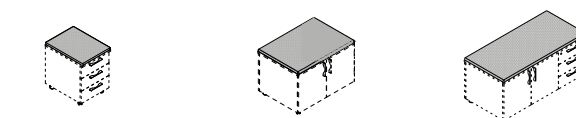

BAR



TB05
Piano ribaltabile diam. cm. 60
Tip-up top diam. cm. 60



TB01
Piano cm 80x80
Top cm 80x80



TB02
Piano diam. cm 80
Top diam. cm. 80



TB03
Piano cm 80x80
Top cm 80x80



TB04
Piano cm 70x70
Top cm 70x70

Tavoli fissi e ribaltabili, con piano in melaminico spessore mm. 25 bordato in ABS mm 2.
Basi zavorrate quadre e tonde oppure basi a calice cromate.

Fixed and tip-up tables with melamine top thickness mm 25 with ABS mm 2 edging. Square and round ballast bases or chrome-plated chalice bases.



TB06
Piano cm 60x60
Top cm 60x60



TB07
Piano diam. cm. 60
Top diam. cm. 60



TB08
Piano cm 60x60
Top cm 60x60



TB09
Piano cm 70x70
Top cm 70x70

Tavoli fissi, con piano in melaminico spessore mm. 25 bordato in ABS mm 2. Basi zavorrate quadre e tonde oppure basi a calice cromate.

Fixed tables with melamine top thickness mm. 25 with ABS mm 2 edging. Square and round ballast bases or chrome-plated chalice bases.



Ambiente con tavoli e sedute modello OPEN.
An environment with tables and OPEN model chairs.

ATTESA WAITING



TB16
Piano cm 60x60
Top cm 60x60



TB17
Piano cm 60x60
Top cm 60x60



TB18
Piano cm 60x60
Top cm 60x60



TB19
Piano cm 60x60
Top cm 60x60

Tavoli attesa, con piano in melaminico spessore mm. 25 bordato in ABS mm 2 oppure con piani in vetro trasparente o acidato. Basi zavorrate quadre, tonde oppure basi a calice cromate.

Waiting tables with melamine top thickness mm 25 with ABS mm 2 edging or with transparent or etched glass tops. Square or round ballast bases or chrome-plated chalice bases.



TB10
Piano cm 50x50
Top cm 50x50



TB11
Piano cm 90x50
Top cm 90x50



TB12
Piano cm 50x50
Top cm 50x50



TB13
Piano cm 90x50
Top cm 90x50



TB14
Piano cm 50x50
Top cm 50x50



TB15
Piano cm 90x50
Top cm 90x50

Tavoli attesa, con piano in melaminico spessore mm. 25 bordato in ABS mm 2 oppure con piani in vetro trasparente o acidato. Basi 4 gambe in metallo grigio, nero o cromato.

Waiting tables with melamine top thickness mm 25 with ABS mm 2 edging or with transparent or etched glass tops. Grey, black or chromed 4 legged bases.



Ambiente con divani modello Swing e tavoli attesa. Libreria ONYX.
An environment with Swing model couches and waiting tables, ONYX bookcases.

RIBALTABILI TILTING



I tavoli ribaltabili sono multifunzione, si possono affiancare e configurare in base alle più svariate esigenze grazie alla molteplicità di misure disponibili. La struttura in metallo è dotata di ruote con freno che ne consentono un rapido e facile spostamento all'interno di qualsiasi stanza. Il piano ribaltabile può essere bloccato e sbloccato facilmente riposto comodamente impilandolo orizzontalmente. Numerosi accessori completano la gamma, rendendolo una soluzione altamente flessibile nell'allestimento di sale meeting di ogni genere, all'interno degli uffici, di sale polifunzionali, di aule didattiche e mensa.

Tilting tables are multifunctional, they can be placed side by side and set up according to the most varied requirements thanks to the multiplicity of available sizes. The metal structure is equipped with braking wheels which allow for a quick and easy movement within any room. The tilting top can be locked and unlocked, easily stored comfortably by stacking it horizontally. Numerous accessories complete the range, making it a highly flexible solution in setting up all kinds of meeting rooms, in offices, multi-purpose rooms, teaching rooms and canteen areas.



Modesty panel il lamiera
Metal sheet modesty panel



Coppia gancio di unione piani
Pair of union hooks for tops



Fermo di bloccaggio piani in verticale
Locking latch for tops in verticle position

PIEGHEVOLI FOLDING



I tavoli pieghevoli possono affiancarsi e configurare in base alle più svariate esigenze. La struttura in metallo è dotata di ruote con freno che ne consentono un rapido e facile spostamento all'interno di qualsiasi stanza. Il piano pieghevole di grandi dimensioni può essere facilmente riposto in un angolo. Soluzione altamente flessibile nell'allestimento di sale meeting di ogni genere, all'interno degli uffici, di sale polifunzionali e di aule didattiche.

Folding tables can be placed side by side and set up according to the most varied needs. The metal structure is equipped with braking wheels which allow for a quick and easy movement within any room. The large folding top can easily be stored in a corner, a highly flexible solution for setting up all kinds of meeting rooms in offices, multipurpose rooms and classrooms.





Tavolo pieghevole. Seduta modello ROMBO.
Folding table and ROMBO model chair.

CHIUDIBILI FOLDING



I tavoli con gambe pieghevoli sono multifunzione, grazie alle tante misure disponibili, si possono affiancare e configurare in base alle più svariate esigenze. Disponibile un carrello che ne permette l'accatastabilità e lo spostamento in magazzino. Soluzione altamente flessibile nell'allestimento di sale meeting di ogni genere, all'interno degli uffici, di sale polifunzionali, di aule didattiche e mensa. Utilissimo per i noleggi.

Tables with folding legs are multifunctional, thanks to the many sizes available, they can be placed side by side and configured according to the most varied requirements. A trolley is available for stacking and moving in the warehouse, a highly flexible solution for setting up all kinds of meeting rooms in offices, multi-purpose rooms, classrooms and canteen areas. Very useful for rentals.

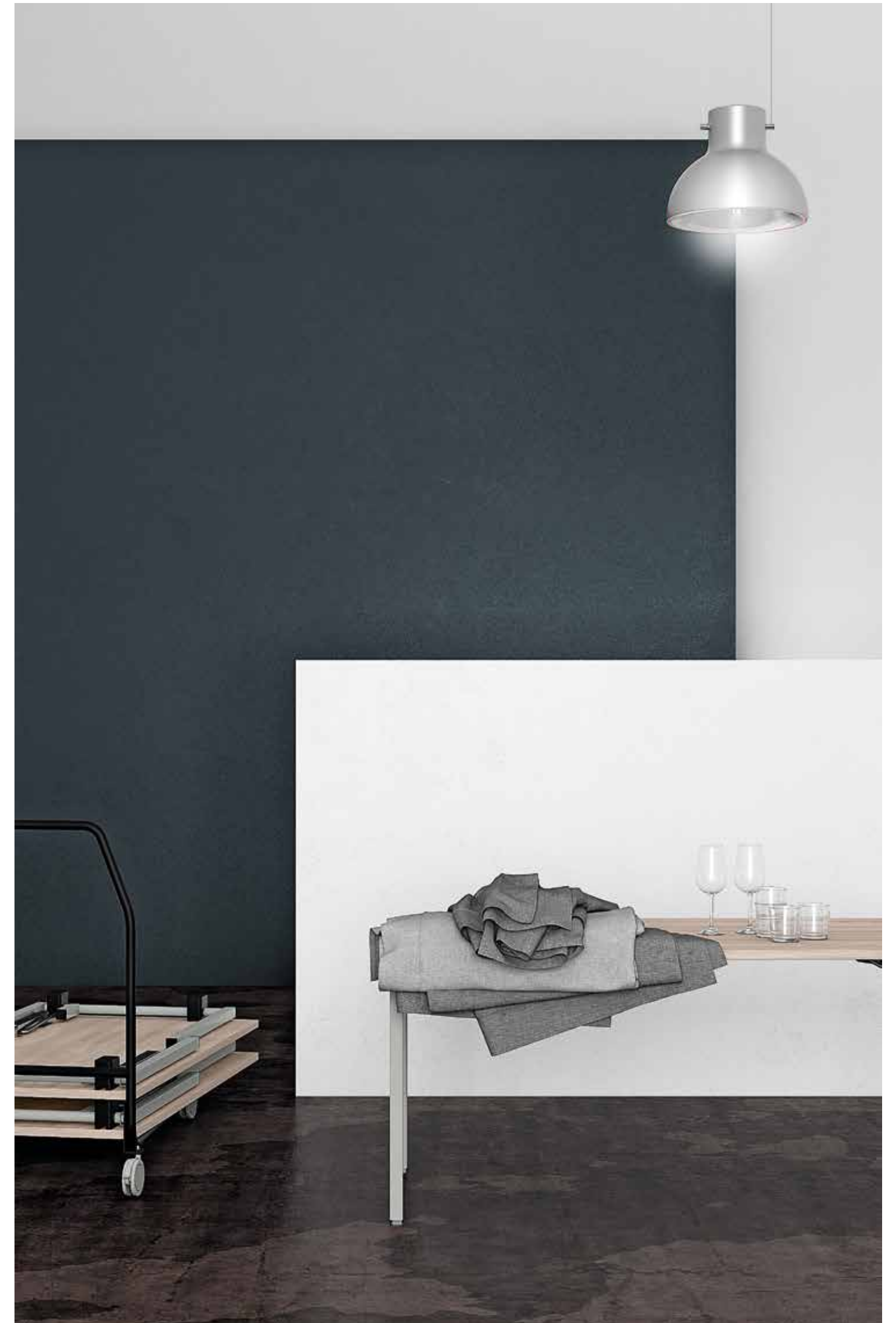

MENSA CANTEEN



I tavoli, disponibili a 4 posti con sedute fisse o girevoli, in lamiera o in plastica. sono stati creati per le mense scolastiche, aziendali eccetera.

The tables are available with 4 fixed or swivel seats made of sheet metal or plastic and have been created for school, canteens, business etc.

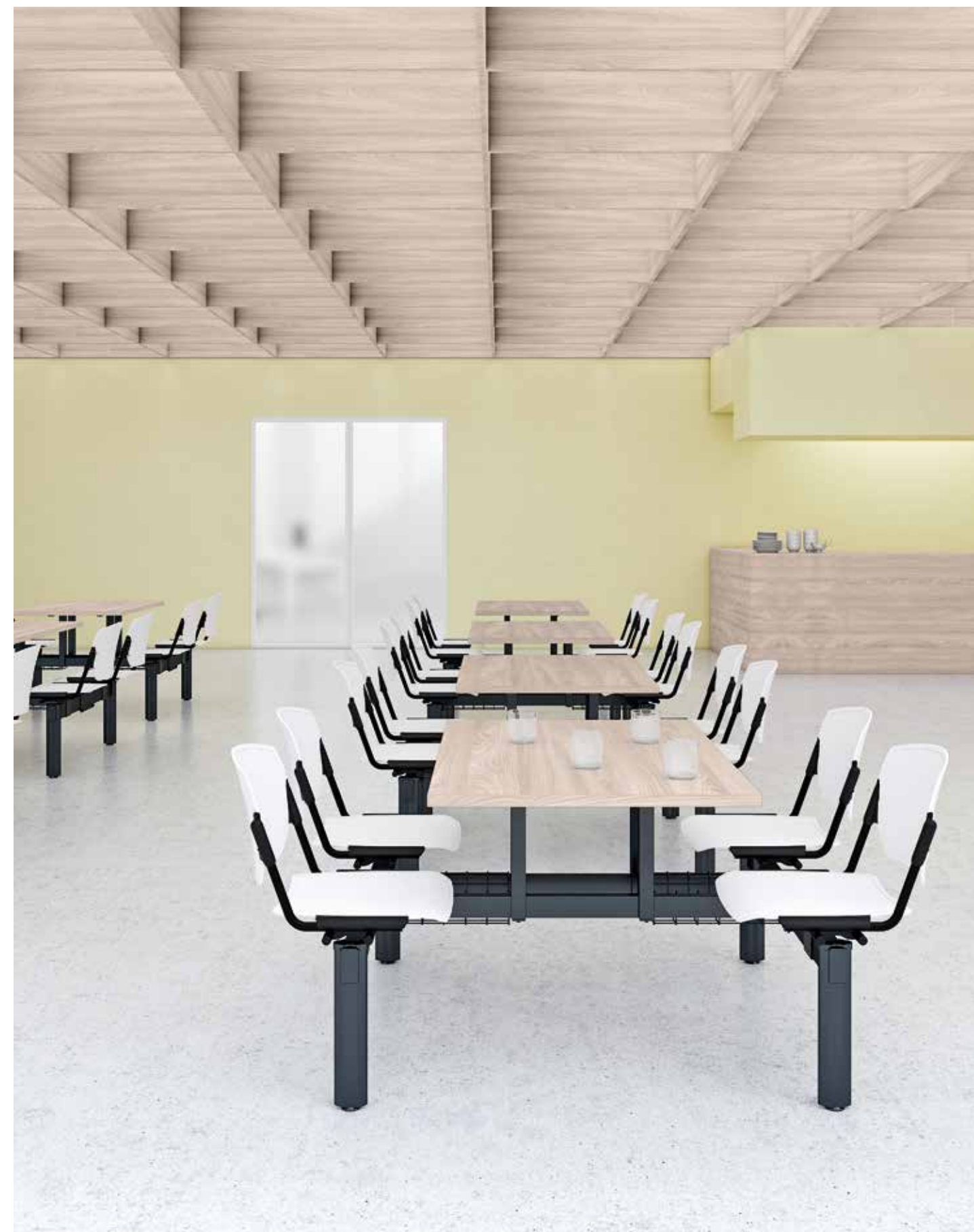

COLORE
COLOUR



BI
Bianco
White



GR
Grigio
Grey



NR
Nero
Black



NC
Noce chiaro
Light walnut



NS
Noce scuro
Dark walnut



OC
Olmo chiaro
Light elm



OS
Olmo scuro
Dark elm



RC
Rovere chiaro
Light durmast



RT
Rovere tabacco
Durmast tabacco

COLORE STRUTTURA
STRUCTURE COLOUR

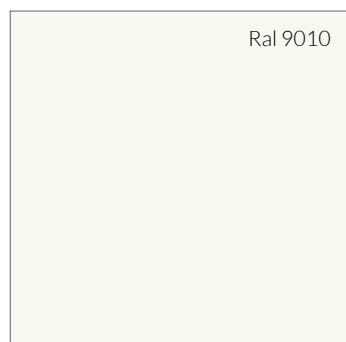

BI
Bianco
White

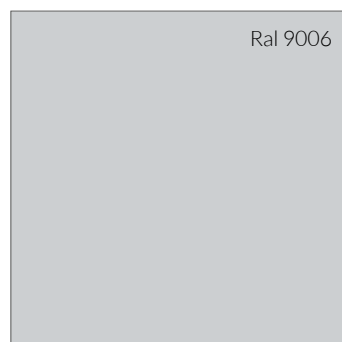

GR
Grigio
Grey

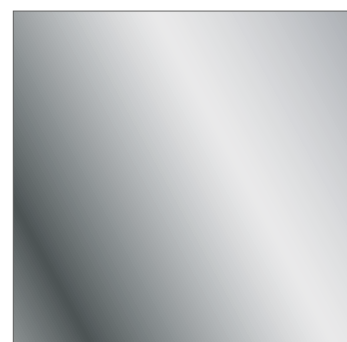

CR
Cromato
Chrome plated

TABLES

BAR

H. 79
H. 79

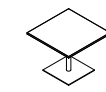

80X80

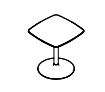
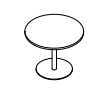

70X70

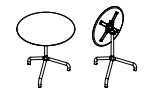

BAR

H. 114
H. 114



60X60



ATTESA / WAITING

H. 40
H. 40



50X50



90X50

H. 40
H. 40



60X60

RIBALTABILI O PIEGHEVOLI / TILTING OR FOLDING

H. 73
H. 73

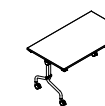

LUNGHEZZE / LENGTHS 120-140-160-180

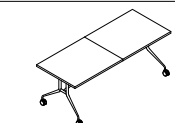

LUNGHEZZE / LENGTHS 200-260-280-320

CHIUDIBILI / FOLDING

H. 73
H. 73

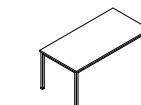

LUNGHEZZE / LENGTHS 120-140-160-180

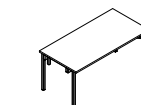
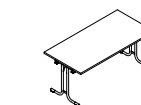

LUNGHEZZE / LENGTHS 80-100-120-140-160-180

MENSA / CANTEEN

H. 73
H. 73

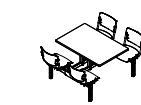
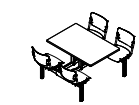

185X120

SEIPO BQ®



Benvenuti in BQ®, la collezione di elementi d'arredo che Seipo ha progettato e creato per migliorare la qualità acustica degli ambienti contemporanei, in modo elegante e discreto con un'ampia gamma di soluzioni.

Spesso gli spazi pubblici oggi sono troppo rumorosi e creano stress nelle persone, riducendo la qualità delle loro relazioni umane, la loro capacità di collaborare e condividere.

Anche i grandi open space operativi, dedicati al lavoro o allo studio, hanno bisogno di nuovi accorgimenti per offrire comfort e favorire la collaborazione.

LA QUIETE È SU MISURA

Progettare spazi dove vivere, lavorare, condividere significa anche garantire una condizione di benessere.

Il rumore fa parte della modernità e della socialità ma è possibile contenerne l'impatto in modo sensibile.

Seipo BQ® si occupa di rendere gli ambienti più confortevoli, con efficacia ed eleganza su misura.

IL PROGETTO

Nella fase di progettazione analizziamo le vostre esigenze e le tipologie di spazio, per capire come intervenire e aiutarvi a trovare le soluzioni giuste.

IL PRODOTTO

Nella collezione Seipo BQ® potete scegliere arredi, pannelli decorativi ed elementi invisibili che offrono eccellenti risultati in termini di benessere acustico, oltre che arredare con il loro design.

LA PERSONALIZZAZIONE

Colori, tessuti, decorazioni possono essere personalizzati in base al vostro stile e alle caratteristiche degli spazi a cui sono destinati.

Welcome to BQ®, the collection of decorative elements that Seipo has designed and created to enhance the quality of sound in contemporary environments, in an elegant and discreet way with a broad range of solutions.

Often public spaces today are too noisy and create stress in people, reducing the quality of their human relationships, their ability to collaborate and share.

Even the large operational open spaces, dedicated to work or study need new devices to provide comfort and promote collaboration.

SILENCE IS CUSTOM-MADE

Designing spaces for living, working and to share also means ensuring a state of wellness.

Noise is part of modernity and sociality but it is possible to contain its impact significantly.

Seipo BQ® is aimed to make environments more comfortable with effective and custom-made elegance.

THE PROJECT

During the designing phase, we analyze your needs and the types of space to understand how to intervene and help you find the right solutions.

THE PRODUCT

You can choose furniture, decorative panels and invisible elements in Seipo's BQ® collection which offers excellent results in terms of acoustic comfort, as well as furnish with your design.

CUSTOM-MADE

Colours, fabrics, and decorations can be customized according to your style and the characteristics of the spaces for which they are intended.

Ovviamente il silenzio assoluto non esiste: per migliorare il comfort acustico, più che tendere al raggiungimento di questa condizione, è necessario minimizzare il rumore, comunemente identificato come una sensazione uditiva sgradevole e fastidiosa o intollerabile.

Uno degli elementi da tenere sotto controllo per diminuire il disagio acustico negli ambienti chiusi è il riverbero.

In acustica architettonica il fenomeno di riverbero dovuto a riflessioni del suono sulle superfici di un ambiente si chiama "Riverberazione" e con "Tempo di riverberazione" si intende la durata della "coda sonora" che i suoni, e soprattutto le frequenze del parlato (150-1000 Hz.), lasciano nell'ambiente stesso, come effetto della riverberazione e a causa della velocità del suono, che non produce una cessazione immediata al suo interrompersi.

Se il tempo di riverberazione è troppo lungo, o comunque inadeguato, l'ambiente si dice riverberante o rimbombante e i suoni tendono a fondersi riducendo la comprensibilità del parlato.

Intervenire sui livelli di riverberazione significa migliorare la qualità acustica, migliorando l'intelligibilità del parlato e il livello di privacy.

Purtroppo gli edifici non sono sempre progettati tenendo conto dell'esigenza di controllare i valori di riverberazione.

Per questo motivo è necessario intervenire successivamente, nel modo meno invasivo possibile, per non modificare l'impianto architettonico degli ambienti.

Il programma BQ® è la soluzione a questo problema, in quanto contempla diverse tipologie di pannelli con diverse applicazioni, e prevede anche una serie di arredi e complementi, che permettono un adeguato assorbimento acustico.

Inoltre, dato l'alto grado di customizzazione e di flessibilità produttiva, consente la realizzazione di elementi personalizzati. In questo modo il progettista sarà in grado di correggere il tempo di riverberazione, senza incidere sulla qualità estetica dell'ambiente o sul progetto originario, attraverso un'integrazione perfetta degli elementi acustici, senza i vincoli imposti dai pannelli di serie.

Obviously, absolute silence does not exist: in order to improve acoustic comfort rather than strive to achieve this condition, you need to minimize noise, commonly identified as an unpleasant or annoying and intolerable auditory sensation.

Reverberation is one of the elements to be kept under control to decrease noise discomfort indoors.

In architectural acoustics the reverberation phenomenon is due to sound reflections on the surfaces of a room, it is called "Reverberation" and "Reverberation time" means the duration of the "echo" of the sounds and especially the speech frequencies (150-1000 Hz.), which remain in the environment as the effect of reverberation due to the speed of sound, which does not produce an immediate cessation to its stop.

If the reverberation time is too long or inadequate, the environment is said to be reverberant or echoing and the sounds tend to merge reducing speech comprehension.

Intervening on the levels of reverberation means improving sound quality, speech intelligibility and privacy.

Unfortunately, buildings are not always designed in consideration for the need to control reverberation measurements.

For this reason it is necessary to intervene later in the least invasive way possible, without modifying the architectural layout of the environments.

The BQ® program is the solution to this problem, it provides different types of panels for different applications, and for a series of furniture and accessories which allow for an adequate sound absorption.

Moreover, given the high degree of customization and production flexibility, it allows for the creation of customized elements. In this way, the designer will be able to correct the time of reverberation without affecting the aesthetic quality of the environment or on the original project, through a perfect integration of acoustic elements, without the constraints set by standard panels.

SEIPO BQ®

**BQ=BE QUIET**

Il programma BQ® è frutto di una intensa attività di ricerca e sviluppo tuttora in corso. Il programma BQ® è stato sviluppato, progettato e realizzato totalmente in Italia. Le soluzioni tecniche ed acustiche di BQ® prendono forma e colore in quanto parte visibile e caratterizzante di un progetto, integrandosi con discrezione negli ambienti. I problemi di acustica, dai più semplici ai più complessi, vengono affrontati dal programma BQ® con una gamma articolata di prodotti basati su un'unica tecnologia.

La gamma dei prodotti BQ® è disponibile in una molteplicità di forme e di colori, con vari tipi di sistemi di supporto, e permette di risolvere differenti problemi acustici, grazie alla capacità di assorbire le frequenze acustiche, soprattutto di quelle fra i 150 e i 1000 Hz, tipiche del parlato.

La tecnologia BQ®, si basa sull'utilizzo di pannelli composti da materiale ad alta densità, che permette di ottenere un assorbimento delle diverse frequenze e quindi di ottimizzare l'acustica dell'ambiente. Lo spessore molto contenuto dei pannelli, mm 30 e/o mm 45 e la presenza di un telaio interno, consente diverse applicazioni e soluzioni. Il materiale con cui sono realizzati i pannelli, li rende estremamente leggeri, poco ingombranti e adattabili ad ogni ambiente.

BQ=BE QUIET

The BQ® program is the result of intensive research and development which is still ongoing. It was entirely developed, designed and built in Italy. The BQ® technical and acoustic solutions take shape and colour as a visible and distinctive part of a project, integrating with discretion in environments. The acoustic problems, from the simplest to the most complex are dealt by the BQ® program with a comprehensive range of products based on a single technology.

The BQ® range of products is available in a variety of shapes and colours, with various types of support systems and allows to resolve different acoustic problems thanks to its ability to absorb acoustic frequencies, particularly those between 150 and 1000 Hz of typical speech.

The BQ® technology is based on the use of panels of high-density material, which allows to obtain an absorption of different frequencies and therefore optimize the acoustic environment. The contained thickness of the panels, 30 mm and/or 45 mm and the presence of an internal frame, allow for different applications and solutions. The material with which the panels are made makes them extremely light, small and adaptable to any environment.

È il tessuto del momento:
riciclabile, in Trevira CS® ignifugo in classe 1,
disponibile in una vastissima gamma di colori.

It is the fabric of the moment:
recyclable, Trevira CS® fireproof in class 1,
available in a wide range of colors.

Poliestere eco-bio-sostenibile fabbricato
con materie prime di recupero al 100%:
totale riciclabilità, altissimo grado di fono-
assorbimento, ignifugo in classe 1.

Polyester eco-bio-sustainable
manufactured with 100% recovery raw
materials: fully recyclable, high degree of
sound absorption, fireproof in class 1.

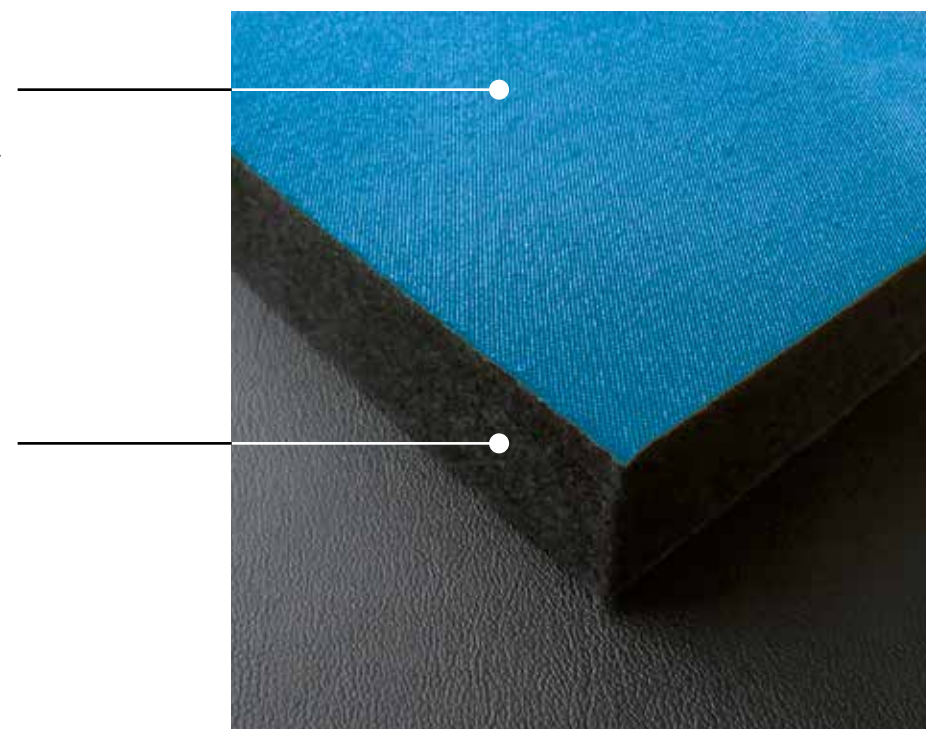

Le superfici sono rivestite in tessuto di poliestere Trevira CS®, cucite e rifinite alle estremità oppure solidamente applicato all'imbottitura interna con la quale forma un corpo unico. Questi sistemi permettono di ottenere un prodotto che, pur essendo visivamente morbido, presenta una superficie, non facilmente strappabile o forabile e facilmente pulibile con detergenti specifici.

Il programma BQ® è stato progettato con l'obiettivo di ottenere la totale riciclabilità del prodotto a fine vita, in modo semplice e rapido. Questo è uno dei motivi per cui i prodotti sono stati realizzati interamente in poliestere, quindi riciclabili al 100% senza necessità di dover separare il tessuto esterno dal materiale fonoassorbente interno, fatta eccezione per il pannello con anima interna.

I pannelli non contengono formaldeide, come dimostrato dal test eseguito secondo la norma UNI EN 717-2. Il materiale fonoassorbente interno è prodotto con materiale riciclato fino al 30%. I pannelli non contengono feltri o altri materiali di origine organica difficilmente riciclabili. Lavorazioni e materiali di alta qualità allungano la vita del prodotto con conseguente minor consumo di materiali ed energia.

The surfaces are upholstered in Trevira CS® polyester fabric, sewn and finished at the extremities and solidly applied to the internal padding with which it forms a single body. These systems allow to obtain a product which, while being visually soft, has a surface which does not easily tear or pierce and is easy to clean by means of specific detergents.

The BQ® program was designed with the objective to obtain total recyclability of the product at the end of its life, in a simple and rapid way. This is one of the reasons why the products are entirely made of polyester, 100% recyclable without the need of having to separate the outer fabric from the internal sound absorbing material, except for the internal core of the panel.

The panels do not contain formaldehyde as demonstrated by tests performed according to the UNI EN 717-2. The internal sound absorbing material is made of recycled material up to 30%. The panels do not contain felts or other organic materials which are difficult to recycle. Workmanship and high quality materials extend the life of the product resulting in lower consumption of materials and energy.



ISTITUTO
GIORDANO





OPEN SPACE COWORKING

È dimostrato che il rumore percepito negli ambienti di lavoro e le conversazioni dei colleghi, generano disturbo incidendo sul livello di concentrazione e sulla performance, sul tasso di assenteismo, sulla frequenza di ritardi e risulta inoltre uno degli elementi negativi per il benessere percepito dai lavoratori.

It is a proven fact that noise perceived in the workplace and conversations of colleagues generate a disturbing impact on the level of concentration and performance, the rate of absenteeism, frequency of delays and is also one of the negative elements perceived by workers' well-being.

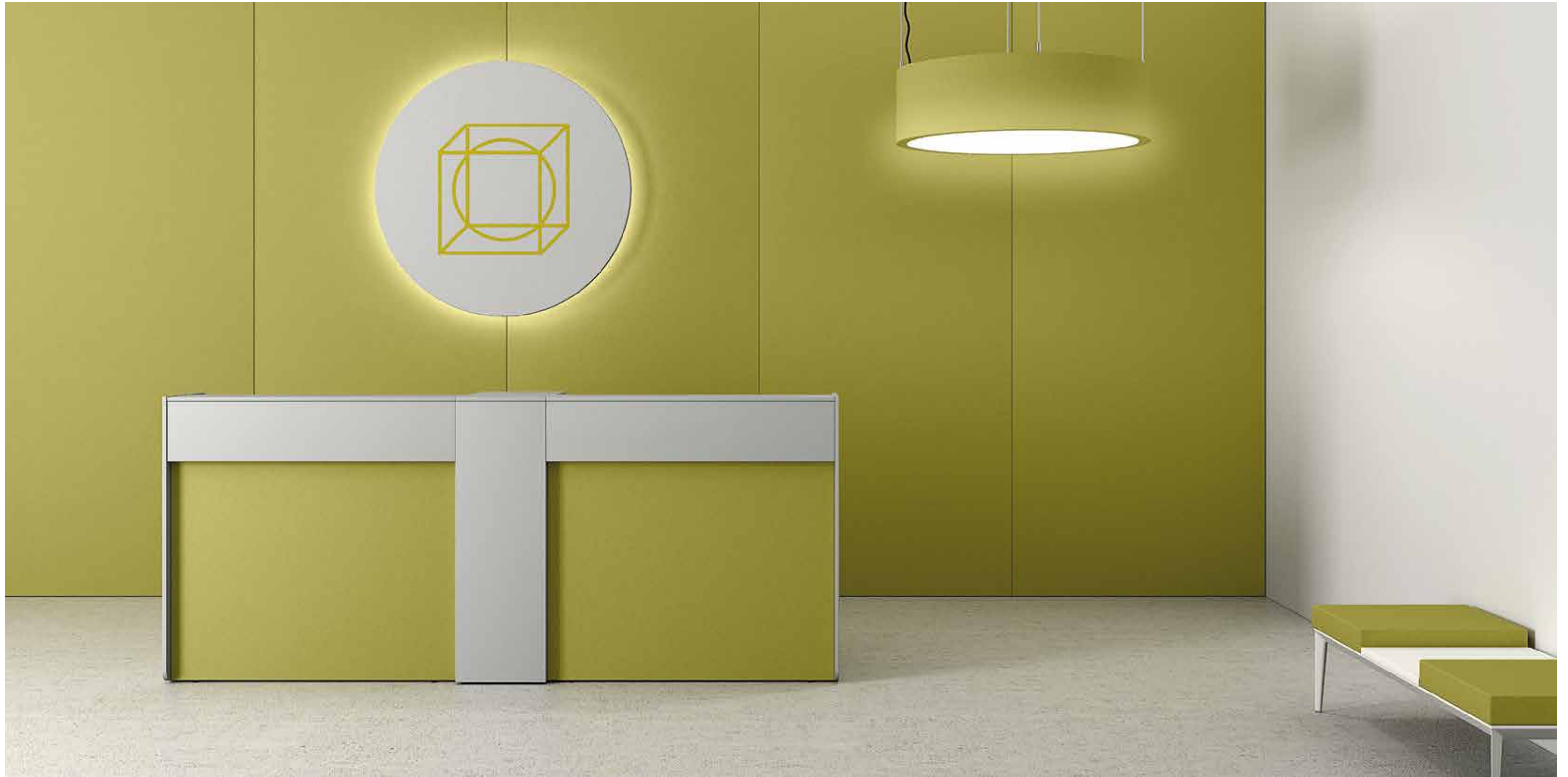

HALL E LOUNGES

HALLS AND LOUNGES

In questo tipo di ambienti un fattore molto importante è la privacy, ovvero il fatto che le proprie conversazioni non siano percepite dagli altri.

Un allestimento che prevede arredi e complementi antiriverberanti consente di raggiungere questo risultato.

Privacy is a very important factor in this type of environment, ensuring that personal conversations are not perceived by others.

A set-up which provides furniture and anti-reverberating compliments allows to reach this result.



SPAZI COMUNI COMMON SPACES

Quando tante persone affollano contemporaneamente uno spazio pubblico potrebbe sembrare inevitabile dover sopportare un fastidio acustico, prodotto dal “vociare” delle persone. Ma non è così. L’installazione di pannelli e arredi specificamente progettati può ridurre sensibilmente questo disagio.

When many people crowd a public space at the same time, it may seem inevitable to have to endure an acoustic discomfort produced by the people’s “voices”. But it isn’t so.

The installation of specially designed panels and furniture can significantly reduce this discomfort.



RISTORAZIONE FOOD SERVICE

Andare a “pranzo fuori” è un piacere: non è solo degustare un buon cibo, ma anche poter dialogare con i nostri commensali, senza essere disturbati dalle conversazioni dei tavoli vicini. Ma ciò è spesso impossibile senza aumentare considerevolmente lo sforzo vocale. E a queste condizioni andare al ristorante non è più un piacere!

“Dining out” is a pleasure: it isn't only tasting good food, but also to be able to converse with our guests without being disturbed by conversations from neighbouring tables. But this is often not possible without substantially increasing vocal effort. Going to the restaurant is no longer a pleasure in these conditions!



EDUCATIONAL

In ambienti silenziosi come biblioteche e aule studio è spesso impossibile poter avere un dialogo senza disturbare gli altri. Elementi acustici come i “phone-booths” consentono di parlare o telefonare senza arrecare disturbo agli altri.

In quiet environments such as libraries and study halls it is often impossible to have a conversation without disturbing others. Acoustic elements like “phone booths” allow for talking or phoning without disturbing others.

FONOASSORBENZA / SOUNDPROOFING BQ®

CABINE / BOOTHS

Cabine
Booths



LUNGHEZZE / LENGTHS 89-109-129 - ALTEZZA / HEIGHT 180-200

POSTAZIONI DI LAVORO / WORKSTATIONS

Postazioni di lavoro
Workstations

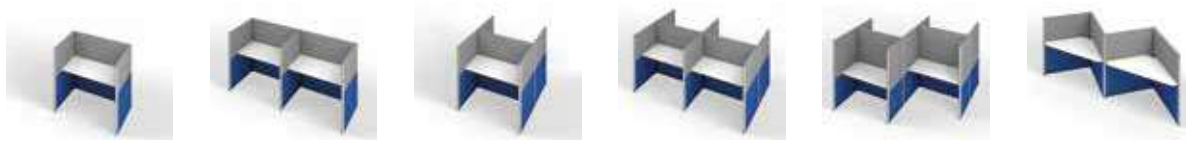

LUNGHEZZE / LENGTHS 89-109-129 - ALTEZZA / HEIGHT 122-135-152-162

PARETINE VERTICALI AUTOPORTANTI / SELF-SUSTAINING VERTICAL PARTITIONS

Paretine
Partitions



LUNGHEZZE / LENGTHS 173,5-213,5-253,5 - ALTEZZA / HEIGHT 112-122-135-152-162-172

PANNELLI ORIZZONTALI / HORIZONTAL PANELS

Pannelli orizzontali
Horizontal panels



LUNGHEZZA / LENGTH 60 - PROFONDITÀ / DEPTH 90 - ALTEZZE / HEIGHTS 89,5-128-166,5-205



LUNGHEZZA / LENGTH 60 - PROFONDITÀ / DEPTH 90 - ALTEZZE / HEIGHTS 89,5-128-166,5-205

PANNELLI VERTICALI / VERTICAL PANELS

Pannelli verticali
Vertical panels



LUNGHEZZE / LENGTHS 80-100-120 - PROFONDITÀ / DEPTH 72 - ALTEZZA / HEIGHT 112

CORPI ILLUMINANTI / LIGHTING FIXTURES

Corpi illuminanti
Lighting fixtures



LUNGHEZZE / LENGTHS 89-109-129 - ALTEZZA / HEIGHT 180-200



LUNGHEZZE / LENGTHS 89-109-129 - ALTEZZA / HEIGHT 180-200

QUADRI / PAINTINGS

Quadri
Paintings



LUNGHEZZE / LENGTHS 89-109-129 - ALTEZZA / HEIGHT 122-135-152-162

PHONE BOOTHS

Phone booths



LUNGHEZZE / LENGTHS 173,5-213,5-253,5 - ALTEZZA / HEIGHT 112-122-135-152-162-172

SEIPO Srl. Tutti i diritti sono riservati.

Ogni riproduzione, anche parziale, di questo documento è proibita senza l'approvazione della ditta SEIPO Srl.

SEIPO Srl si riserva il diritto di cambiare o migliorare tecnicamente design e specifiche di ogni suo prodotto in qualsiasi momento e a sua discrezione senza darne preventiva notizia.

I colori dei campioni e delle fotografie sono solo indicativi, leggeri scostamenti non verranno accettati come reclamo.

SEIPO Srl. All rights reserved.

Any reproduction of this document, even partial, is prohibited without the prior authorisation of the company SEIPO Srl.

SEIPO Srl reserves the right to change or technically improve the design and specifications of any of its products at any time and at its discretion without notice.

The colors of the samples and photographs are only estimates, slight differences will not be accepted as a complaint.

AD: Immagina.biz - Syling: MS Studio
3D images: Ufficio R&S Seipo
Printed 01/2020



SEIPO S.r.l.
Zona Industriale III Fase
97100 Ragusa Italy
Tel. +39 0932 667947
Fax. +39 0932 668203
e-mail: seipo@seipo.it
www.seipo.it