

Night & Day  
Collection



# Night space

ColombiniCasa

IT

La camera e il living si reinventano riscritti dal nuovo alfabeto di una collezione dal design contemporaneo e dall'animo sistemico.

Stile e funzionalità si uniscono in un concept d'arredo basato sulla trasversalità delle finiture e sul potere creativo della modularità.

Un dialogo vivace ed eclettico tra la zona giorno e quella notte.

EN

The bedroom and living area are reinvented by the new lexicon of a collection with a contemporary design and holistic spirit.

Style and practicality come together in a furnishing concept based on versatile finishes and the creative power of modularity. A vibrant and eclectic dialogue between the living area and bedroom.

- p.5 **Introduzione**  
Introduction
- p.9 **L'habitat contemporaneo  
giovane e dinamico**  
The young and dynamic contemporary habitat
- p.71 **La residenza calda e materica**  
The warm and textured residence
- p.137 **L'appartamento d'epoca tra ieri e oggi**  
The period apartment of past and present
- p.197 **Il loft essenziale e luminoso**  
The bright and essential loft
- p.243 **Complementi**  
Accessories
- p.263 **Finiture**  
Finishes
- p.268 **Indice composizioni**  
Index of compositions

Quattro case, quattro mondi che raccontano esigenze abitative e personalità differenti. Locali piccoli e contenuti oppure ampi e importanti, ambienti storici oppure moderni.

Questo catalogo interpreta la camera attraverso quattro stili diversi che esaudiscono il medesimo desiderio di comfort e relax della zona notte e la necessità di soluzioni che contengono e ottimizzano.

Configurazioni che poi trovano continuità nelle possibilità progettuali della zona living.

Four homes, four worlds, each with their own set of living needs and personalities. Small and compact rooms, or else large and spacious, historic or contemporary settings.

This catalogue interprets the bedroom through four distinct styles fulfilling the same desire for comfort and relaxation in the bedroom, together with the need for solutions that both contain and optimise.

Configurations that enjoy continuity in the design possibilities of the living area.



L'habitat contemporaneo giovane e dinamico.  
Legno, luce, delicatezza.  
La calda naturalità dello stile nordico.

The young and dynamic contemporary habitat.  
Wood, light, delicacy.  
The warm naturalness of the Nordic style.



→ vedi catalogo Living Space  
→ see Living Space catalogue

NIGHT SPACE → p.9  
ZONA NOTTE → p.9

La residenza calda e materica.  
Toccare, sentire, vivere.  
La casa che invita ed accoglie.

The warm and textured residence.  
Touch, feel, live.  
The home that invites and welcomes.



→ vedi catalogo Living Space  
→ see Living Space catalogue

NIGHT SPACE → p.71  
ZONA NOTTE → p.71

L'appartamento d'epoca tra ieri e oggi.  
Eleganza e fruibilità.  
Atmosfere lontane e quotidianità moderne.

The period apartment of past and present.  
Elegance and usability.  
Bygone atmospheres and modern life.



→ vedi catalogo Living Space  
→ see Living Space catalogue

NIGHT SPACE → p.137  
ZONA NOTTE → p.137

Il loft essenziale e luminoso.  
Comodità e carattere per ambienti aperti.

The bright and essential loft.  
Comfort and character for open spaces.



→ vedi catalogo Living Space  
→ see Living Space catalogue

NIGHT SPACE → p.197  
ZONA NOTTE → p.197



# N01

Spazi importanti e aperti,  
un mix di texture e finiture  
dai colori tenui e desaturati  
intervallati da legni caldi.  
Il letto al centro della stanza,  
gli armadi a disegnarne lo spazio.

Large open spaces with  
a variety of textures and  
finishes in soft, desaturated  
colours, interspersed  
with warm woods.  
The bed at the centre  
of the room, the wardrobes  
that outline the space.



SCOPRI LE ALTRE COMPOSIZIONI → p.22

SEE THE OTHER COMPOSITIONS → p.22









**IT**  
 Armadio con anta battente Concreta, consolle e maniglia Pul, letto Alba con alzatina retro testata, gruppo Laguna.

**EN**  
 Wardrobe with Concreta swing door, console and Pul handle, Alba bed with rear headboard console table, Laguna set.









**LETTO ALBA | ALBA BED**

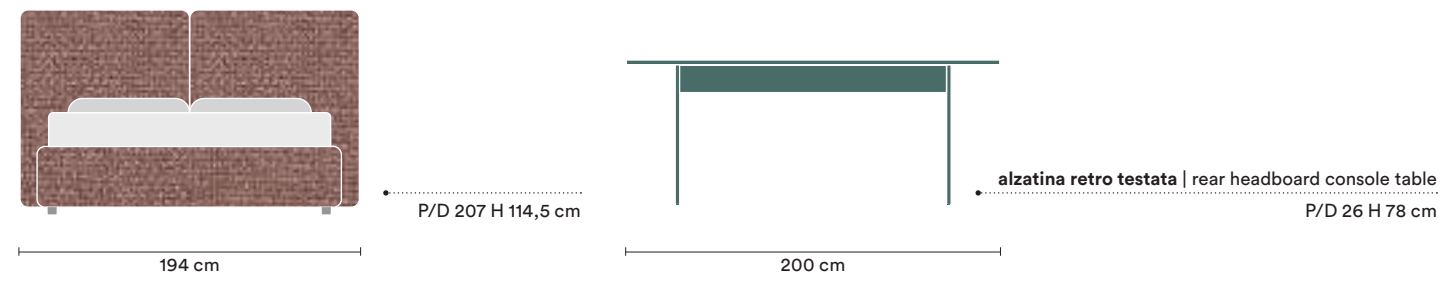

**GRUPPO LAGUNA | LAGUNA SET**

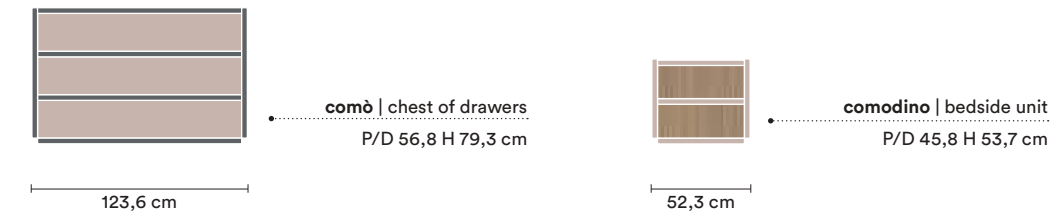

**ARMADIO ANTA BATTENTE CONCRETA E CONSOLLE  
| WARDROBE WITH CONCRETA SWING DOOR AND CONSOLE**

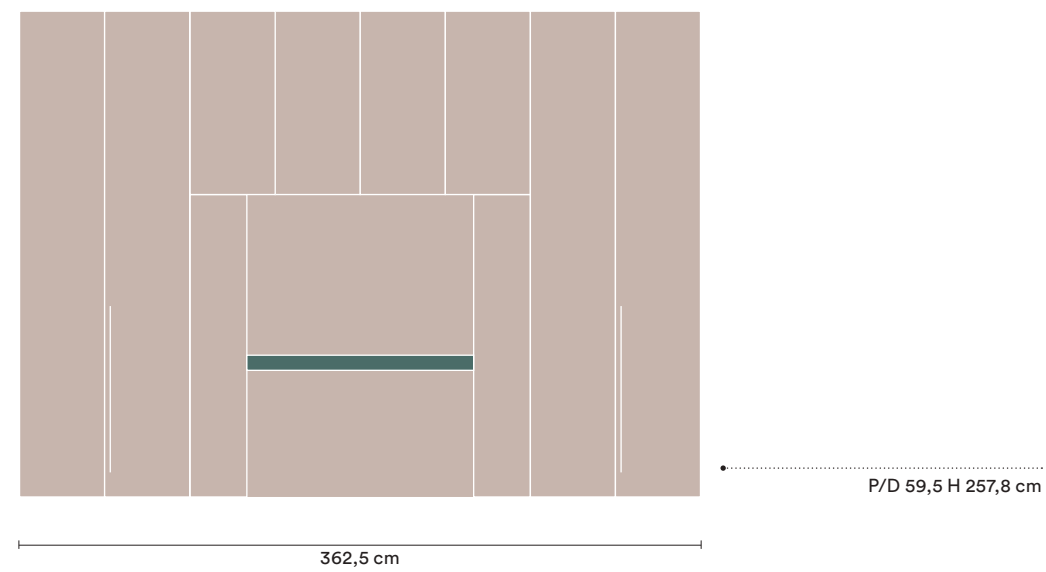

**ARMADIO ANTA BATTENTE CONCRETA CON FIANCO TELAIO ALLUMINIO  
| WARDROBE WITH CONCRETA SWING DOOR AND CONSOLE AND ALUMINIUM SIDE FRAME**

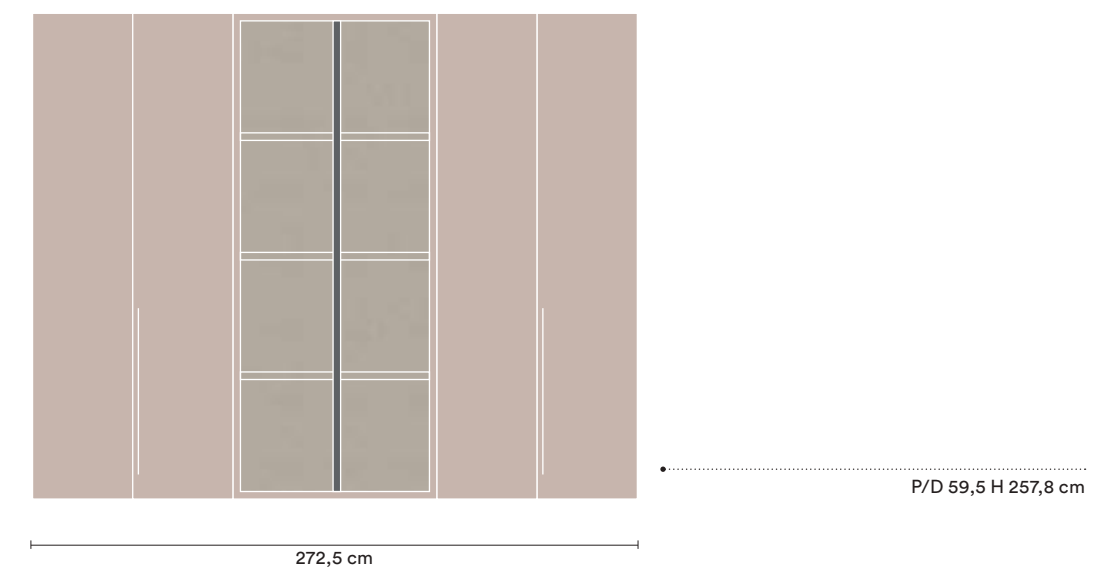

**FINITURE | FINISHES**

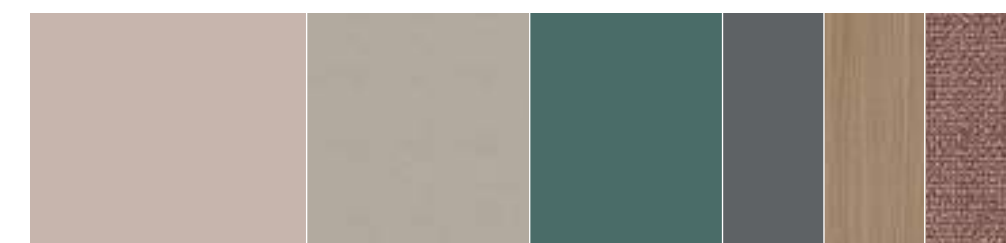

Canapa  
Leather grey  
Verde Alpi  
Grigio titanio  
Noce  
Jenny Coriander



# N02



**IT**  
Armadio con anta battente Window, letto Darsena, gruppo Tower, basi a terra con anta One.

**EN**  
Wardrobe with Window swing door, Darsena bed, Tower set, floor-standing base units with One door.









**LETTO DARSENA | DARSENA BED**

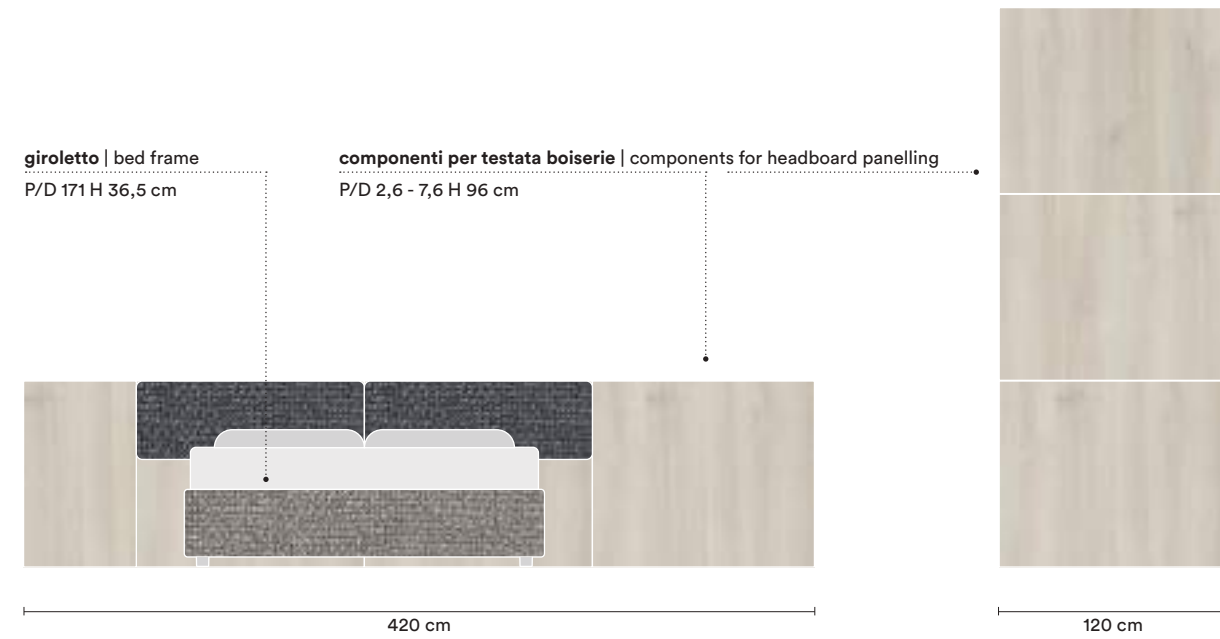

**BASI A TERRA | FLOOR-STANDING BASE UNITS**

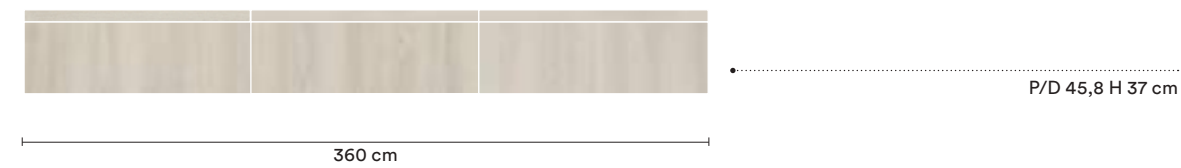

**GRUPPO TOWER | TOWER SET**

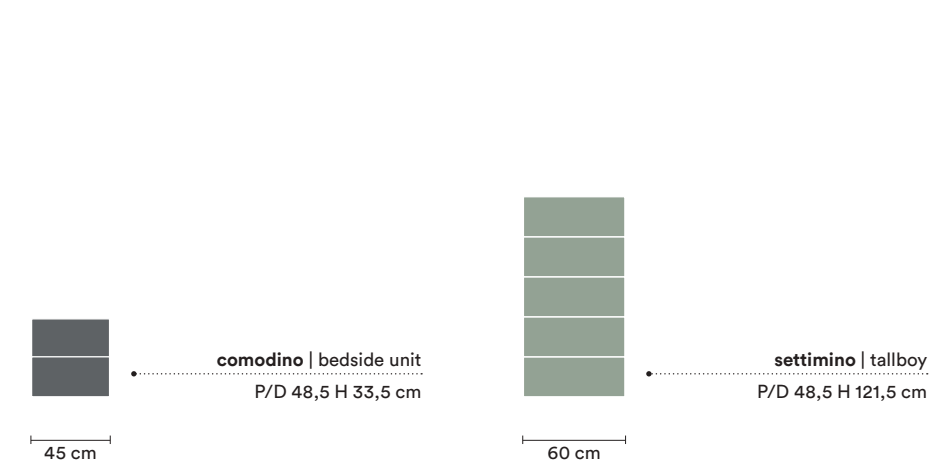

**ARMADIO ANTA BATTENTE WINDOW | WARDROBE WITH WINDOW SWING DOOR**

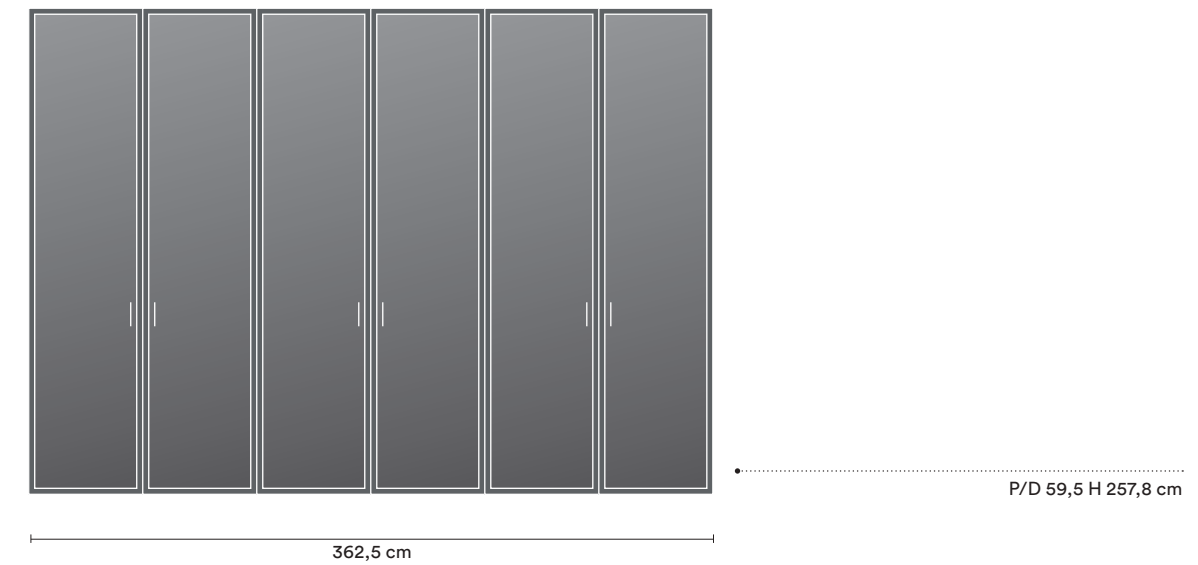

**FINITURE | FINISHES**



Ciliegio bianco  
Agave  
Grigio titanio  
Jenny Smoke  
Jenny Grey



# N03



**IT**  
 Libreria *Infinity* a terra  
 profondità 33,3 cm con vano  
 tv e per passaggio con anta a  
 soffietto e anta battente *Club*,  
 guardaroba *Flexo*, letto *Kiss*,  
 gruppo *Brick*.

**EN**  
*Infinity* floor-standing  
 bookshelf, depth 33.3 cm  
 with TV housing space  
 and through-space with  
 folding door and *Club*  
 swing door, *Flexo* walk-in,  
*Kiss* bed, *Brick* set.









**LETTO KISS | KISS BED**

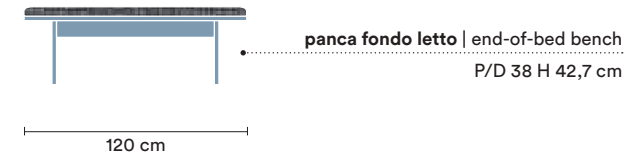
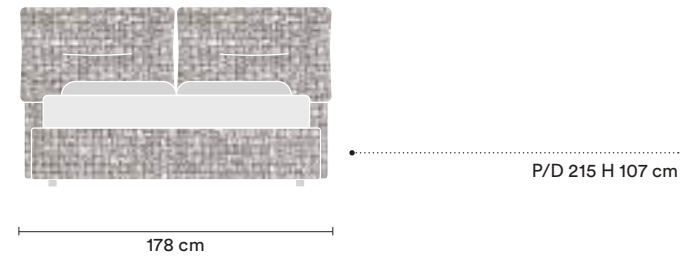

**GRUPPO BRICK | BRICK SET**

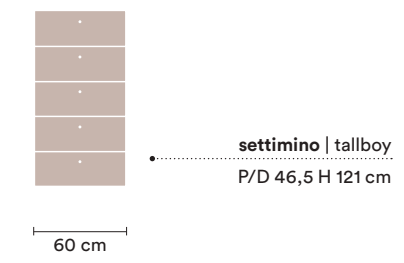
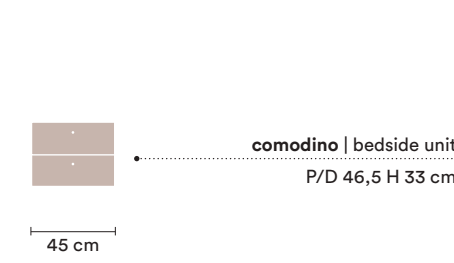

**GUARDAROBA FLEXP | FLEXP WALK-IN CLOSET**

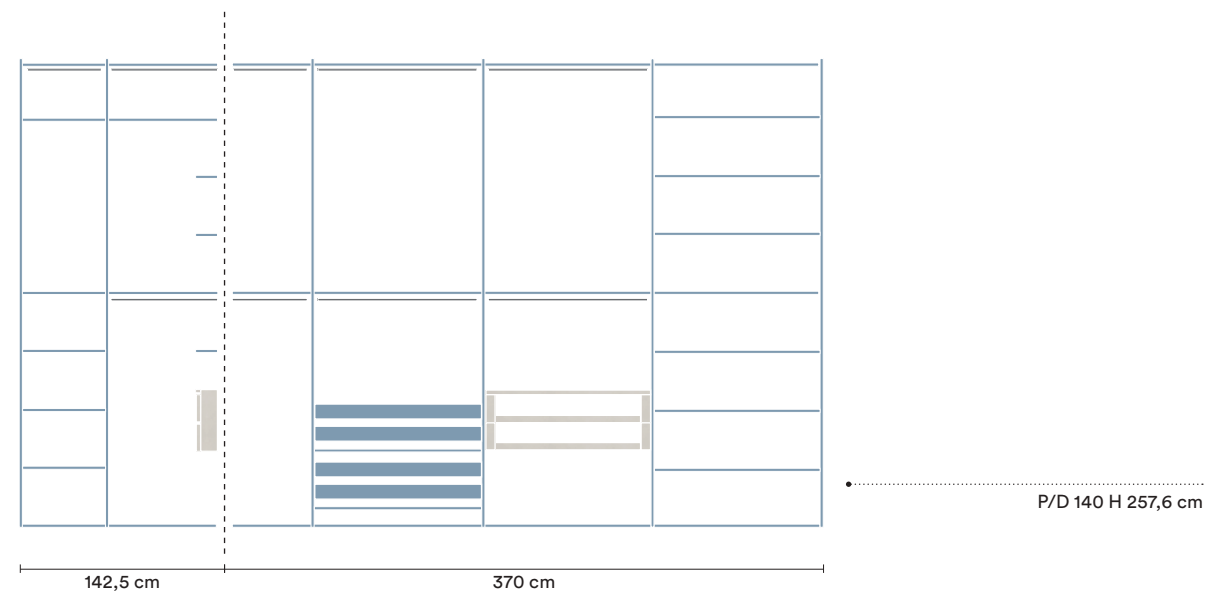

**LIBRERIA INFINITY | INFINITY BOOKSHELF**

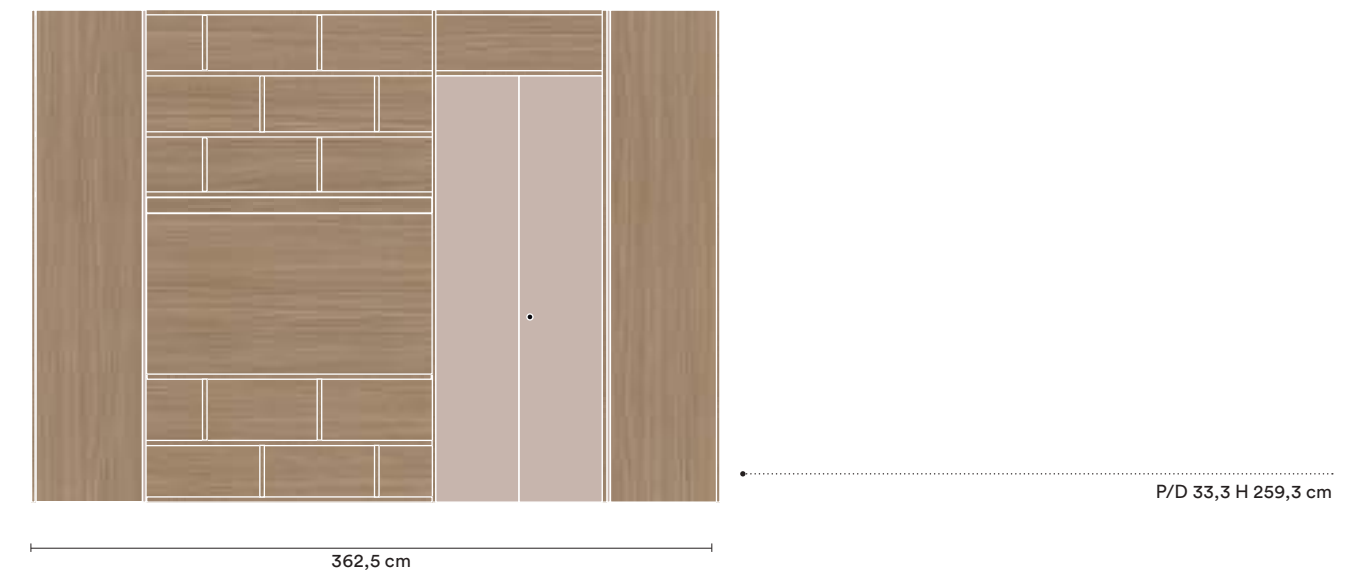

**FINITURE | FINISHES**



- Noce
- Cadaques
- Canapa
- Rovere Dorian
- Ecochic Dorian
- Jenny Smoke



# N04

**IT**  
Armadio con anta scorrevole Style, letto Adagio, gruppo Label.

**EN**  
Wardrobe with Style sliding door, Adagio bed, Label set.









LETTO ADAGIO | ADAGIO BED

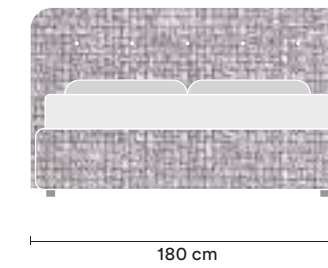

P/D 225 H 108 cm

GRUPPO LABEL | LABEL SET

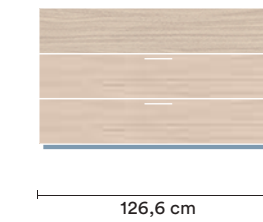

comò | chest of drawers  
P/D 45,2 H 74,8 cm

comodino | bedside unit  
P/D 45,2 H 50,9 cm

ARMADIO ANTA SCORREVOLE STYLE | WARDROBE WITH STYLE SLIDING DOOR



P/D 59,5 H 257,8 cm

FINITURE | FINISHES



Grigio Dorian  
Feltro  
Noce naturale  
Cadaques  
Ecochic Dorian



# N05

**IT**  
 Armadio con anta scorrevole Inserto,  
 sistema boiserie Pepita, giroletto  
Marte, gruppo Gape, basi a terra  
 e pensili con anta One.

**EN**  
 Wardrobe with Inserto sliding door,  
Pepita panelling system, Marte bed  
 frame, Gape set, floor-standing base  
 units and wall units with One door.











**GIROLETTO MARTE E SISTEMA BOISERIE PEPITA | MARTE BED FRAME AND PEPITA PANELLING SYSTEM**

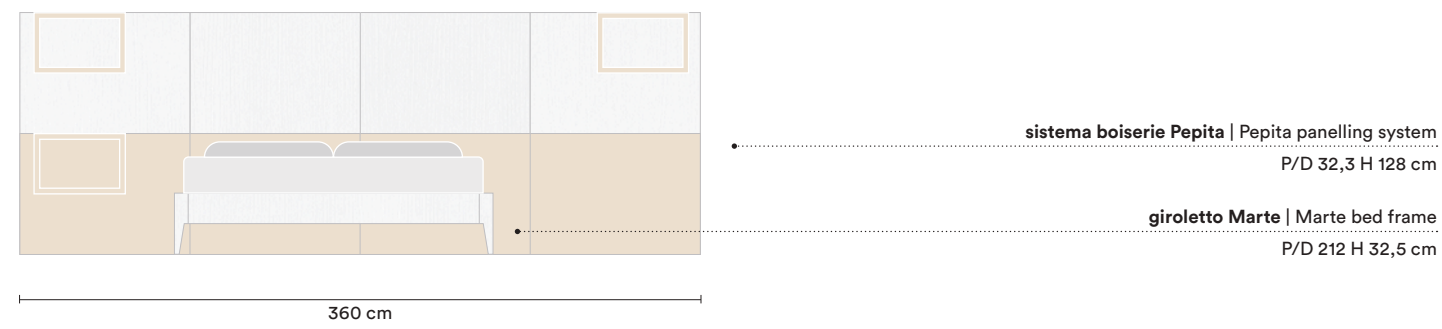

**GRUPPO GAPE | GAPE SET**

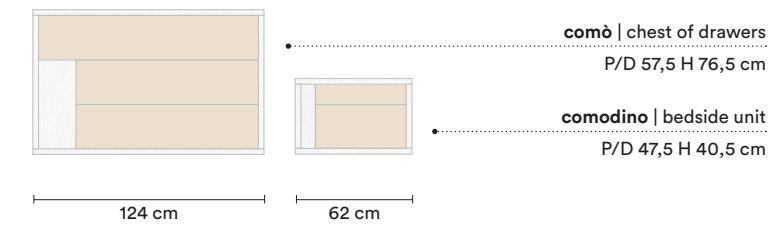

**BASI A TERRA E PENSILI CON ANTA ONE | FLOOR-STANDING BASE UNITS AND WALL UNITS WITH ONE DOOR**

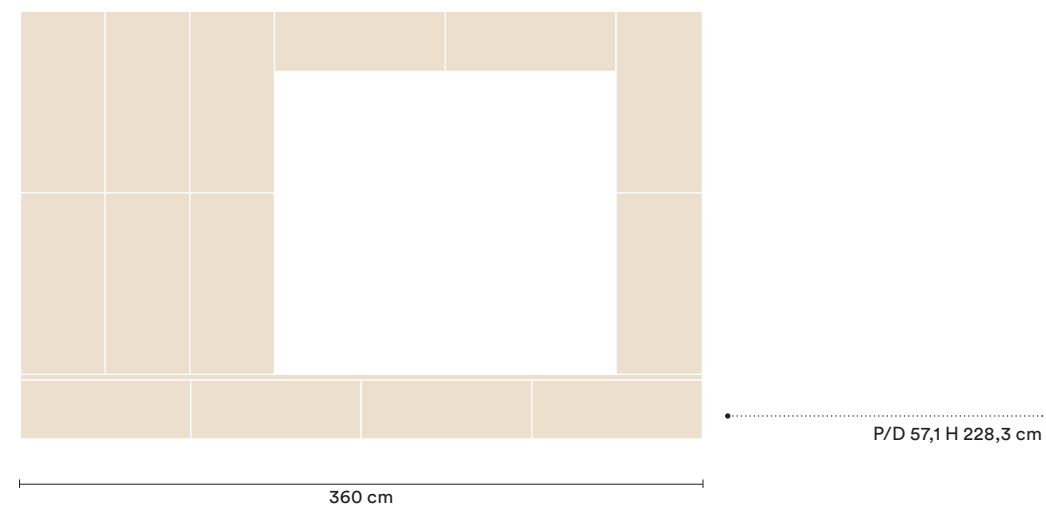

**ARMADIO ANTA SCORREVOLE INSERTO | WARDROBE WITH INSERTO SLIDING DOOR**

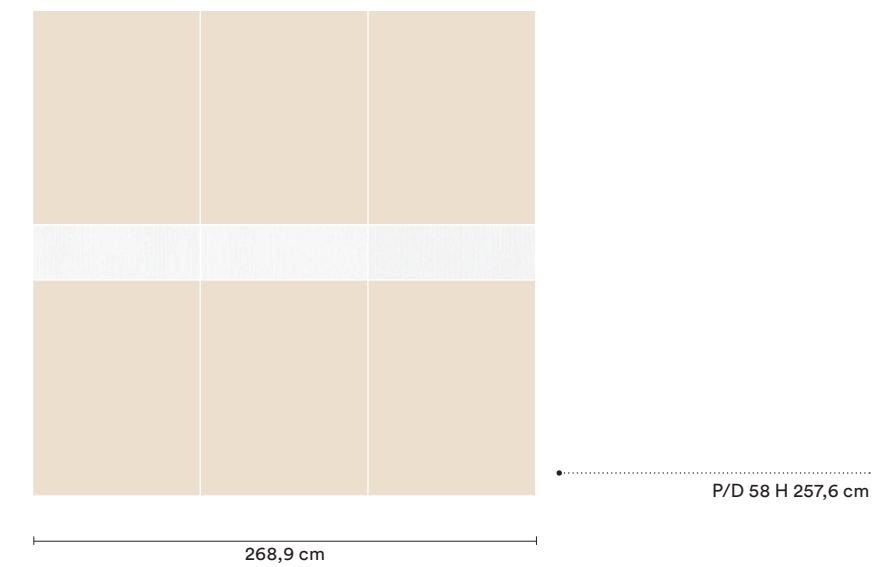

**FINITURE | FINISHES**

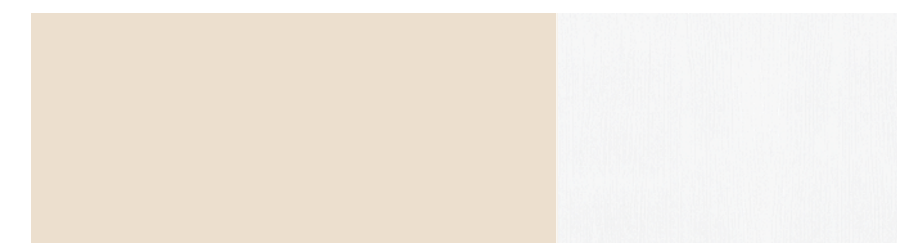

**Desert**  
**Rovere white**



# N06

**IT**  
Armadio con anta battente Concreta, vano porta tv e maniglia Ines, letto Time e gruppo Look su piedini Nume.

**EN**  
Wardrobe with Concreta swing door, TV housing space and Ines handle, Time bed and Look set on Nume feet.







**LETTO TIME | TIME BED**

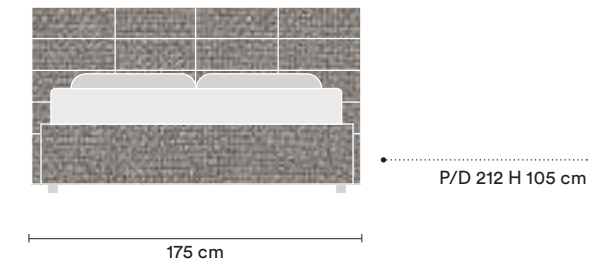

**GRUPPO LOOK | LOOK SET**

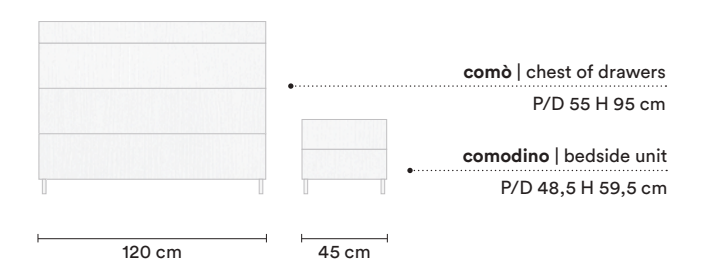

**ARMADIO ANTA BATTENTE CONCRETA | WARDROBE WITH CONCRETA SWING DOOR**



**FINITURE | FINISHES**



**Rovere white  
Ciliegio bianco  
Jenny Grey  
Leather Grey**

# N07

**IT**  
 Armadio con anta battente One  
 e maniglia Pul, nicchia e taglio mansardato,  
 letto Mushy con alloggiamento posteriore  
 e giroletto Marte, gruppo Tower  
 su piedini Epsilon e libreria Up&Up.

**EN**  
 Wardrobe with One swing door  
 and Pul handle, niche and pitched roof cut,  
Mushy bed with rear compartment  
 and Marte bed frame, Tower set  
 on Epsilon feet and Up&Up bookshelf.





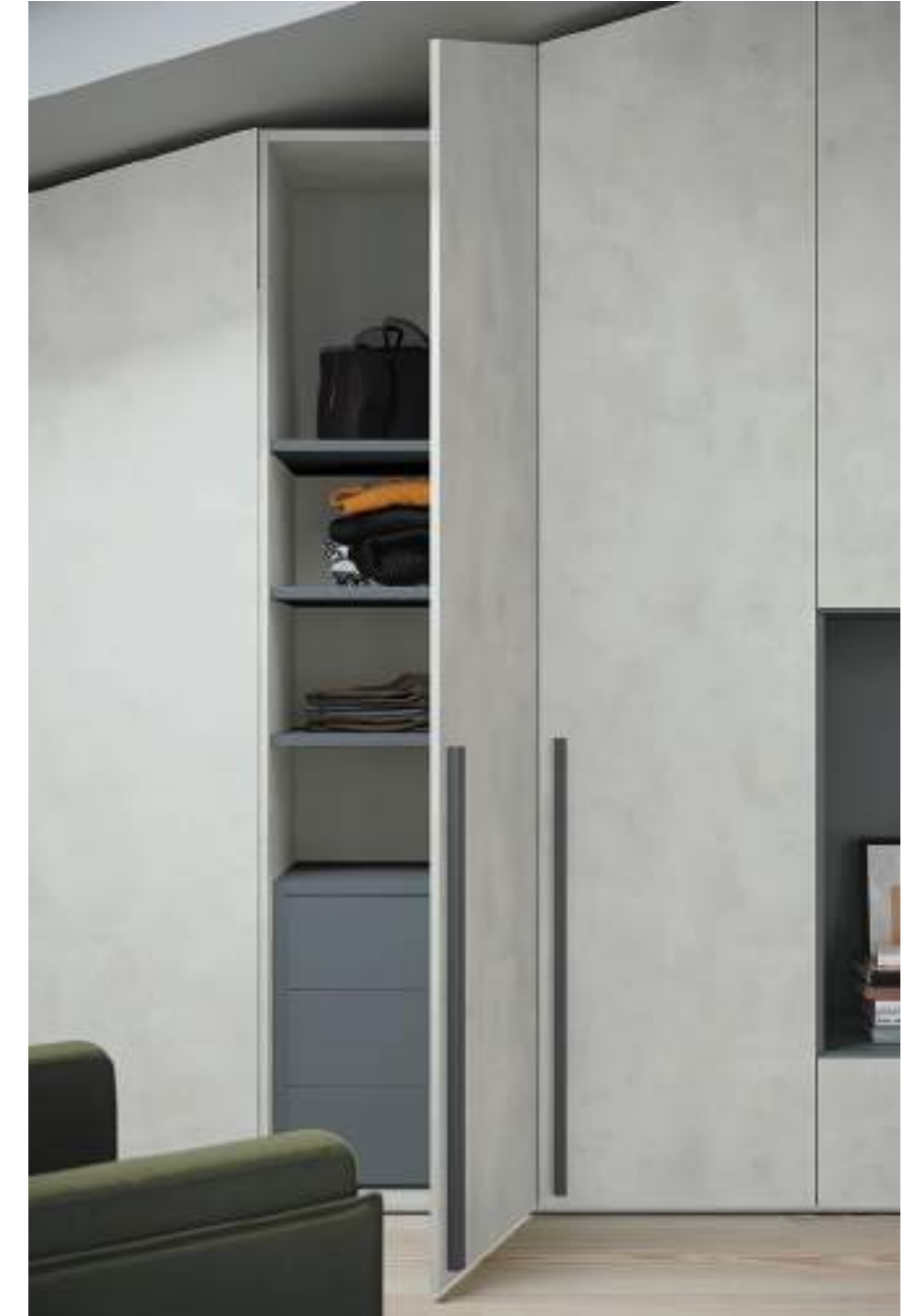



**LETTO MUSHY | MUSHY BED**

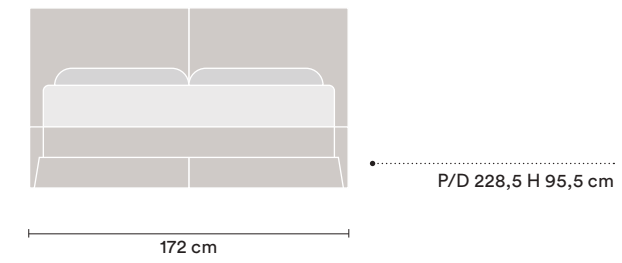

**GRUPPO TOWER | TOWER SET**

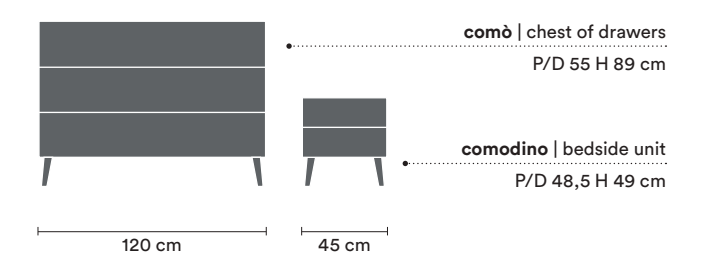

**ARMADIO ANTA BATTENTE ONE  
| WARDROBE WITH ONE SWING DOOR**

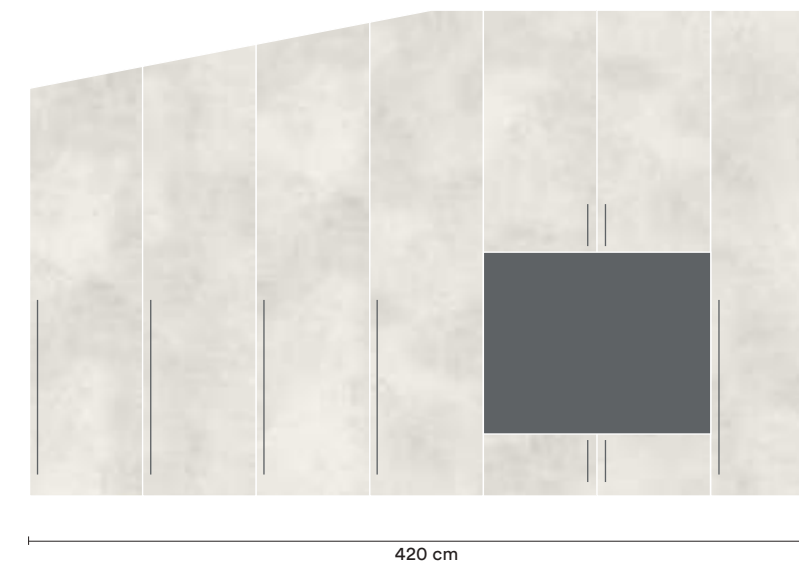

**LIBRERIA UP&UP  
| UP&UP BOOKSHELF**

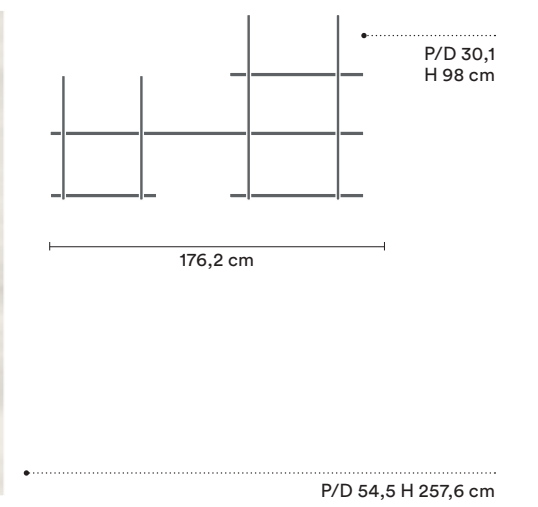

**FINITURE | FINISHES**



Malta  
Grigio titanio  
Grigio Dorian



# N08

**IT**  
 Armadio ad angolo con anta battente Club,  
 ponte Rialto e libreria di sostegno Smart,  
 letto Kant, gruppo Bold su piedini Nume,  
 sistema boiserie Pepita e scrivania Podio.

**EN**  
 Corner wardrobe with Club swing door,  
Rialto overhead wardrobe and Smart  
 support bookshelf, Kant bed, Bold set  
 on Nume feet, Pepita panelling system  
 and Podio desk.









**GIROLETTO KANT | KANT BED**

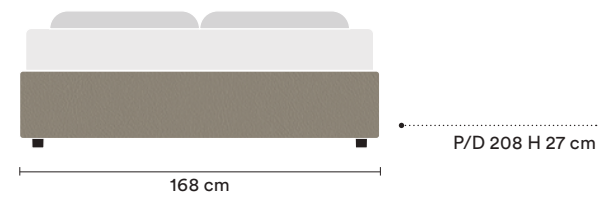

**GRUPPO BOLD | BOLD SET**

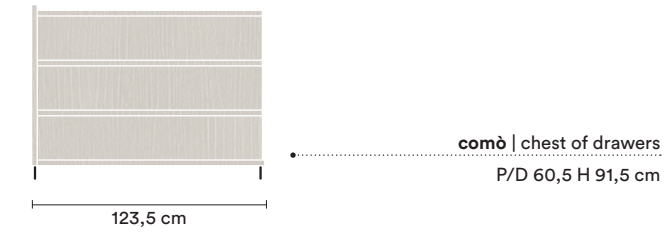

**ARMADIO ANTA BATTENTE CLUB | WARDROBE WITH CLUB SWING DOOR**

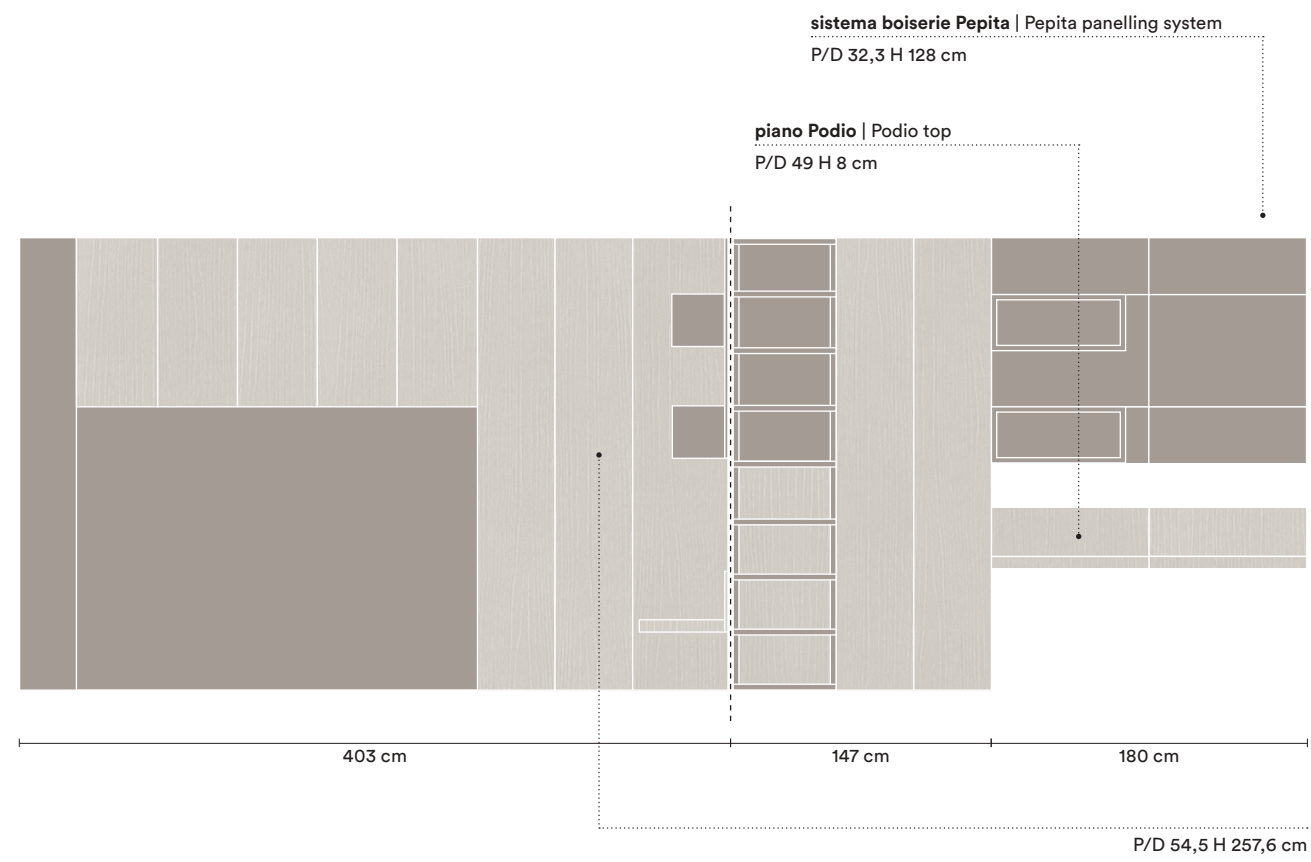

**FINITURE | FINISHES**



Rovere Dorian  
Basalto  
Ecochic Limo





# N09

Un mix di materiali e dettagli studiato per restituire un senso di calore e benessere. La boiserie è resa più coinvolgente e architettonica dall'utilizzo del Noce. Le scelte dei tessuti conferiscono accoglienza all'ambiente. Le ante dell'armadio a due finiture ritmano e danno carattere allo spazio.

A mix of materials and details designed to restore a sense of warmth and wellness. More engaging and architectural panelling thanks to the use of Noce. The choice of fabrics lends cosiness to the room. The two-toned wardrobe doors add rhythm and flair to the space.



SCOPRI LE ALTRE COMPOSIZIONI → p.80

SEE THE OTHER COMPOSITIONS → p.80









**IT**  
 Armadio con anta scorrevole  
 Freedom, letto Darsena,  
 gruppo Quadro.

**EN**  
 Wardrobe with Freedom  
 sliding door, Darsena bed,  
 Quadro set.







**LETTO DARSENA | DARSENA BED**

**giroletto | bed frame**  
P/D 171 H 36,5 cm

**componenti per testata boiserie**  
| components for headboard panelling  
P/D 2,6 - 7,6 - 28,6 H 96 cm

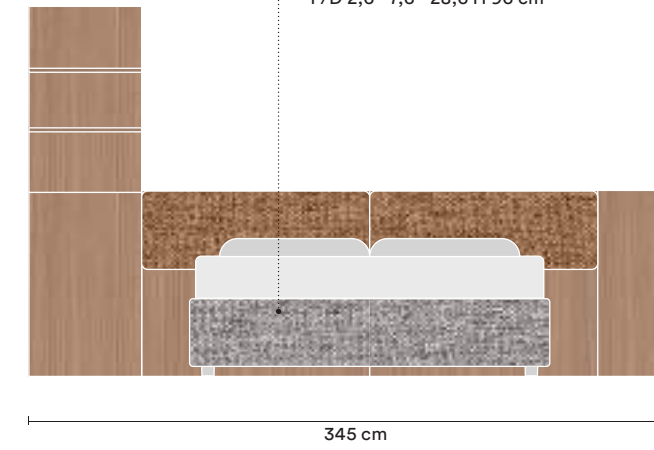

**GRUPPO QUADRO | QUADRO SET**

**comò | chest of drawers**  
P/D 47,5 H 100,5 cm

**comodino | bedside unit**  
P/D 47,5 H 40,5 cm

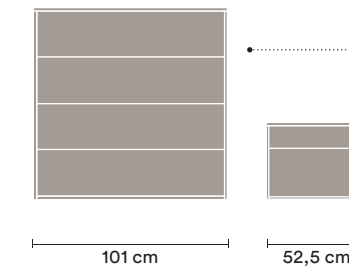

**ARMADIO ANTA SCORREVOLE FREEDOM | WARDROBE WITH FREEDOM SLIDING DOOR**

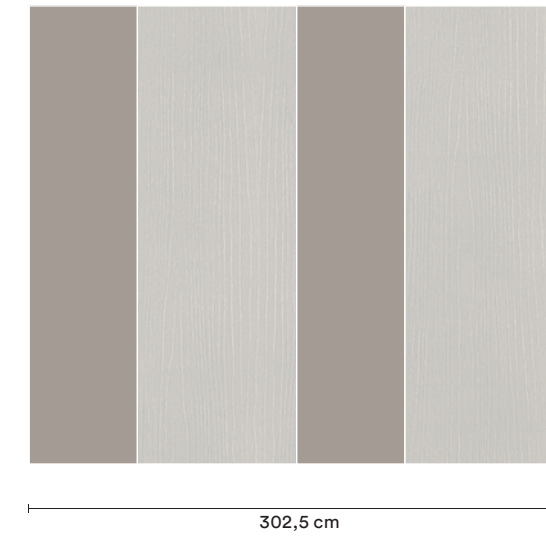

P/D 59,5 H 257,8 cm

**FINITURE | FINISHES**



**Noce**  
**Basalto**  
**Rovere Dorian**  
**Kenya Camel**  
**Kenya Taupe**

# N10



**IT**  
Armadio con anta scorrevole  
Rail, letto Darsena, gruppo  
Laguna.

**EN**  
Wardrobe with Rail sliding  
door, Darsena bed,  
Laguna set.







LETTO DARSENA | DARSENA BED

GRUPPO LAGUNA | LAGUNA SET

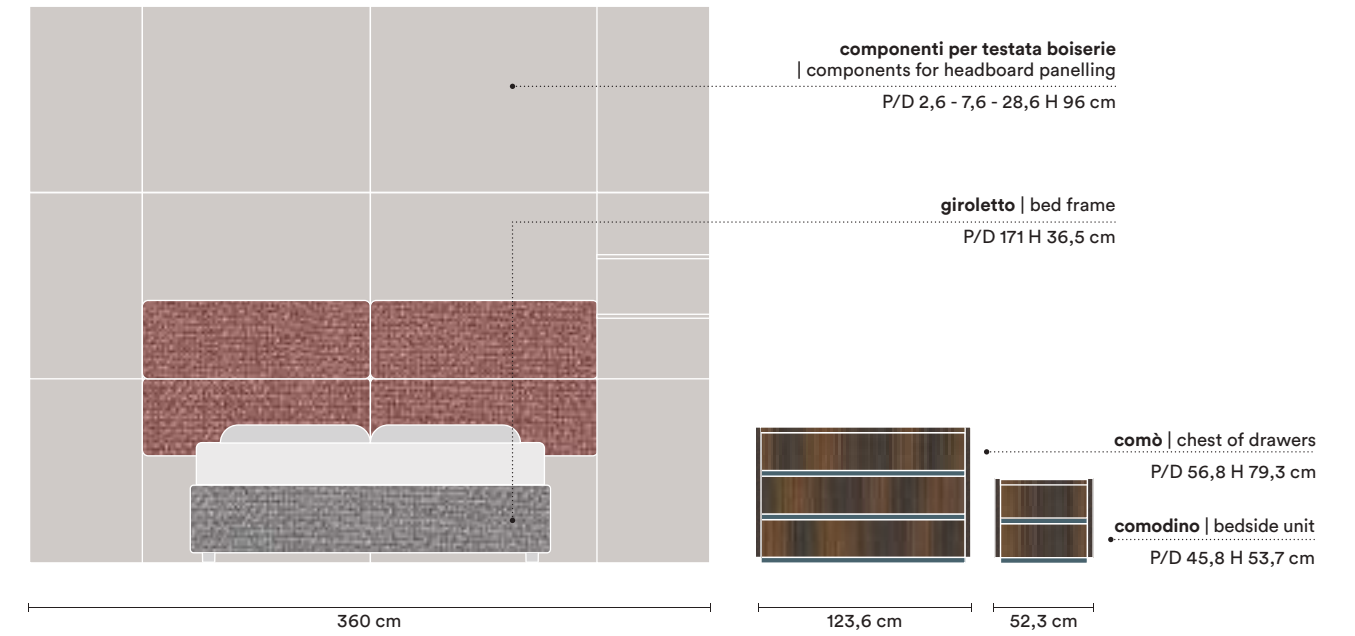

ARMADIO ANTA SCORREVOLE RAIL | WARDROBE WITH RAIL SLIDING DOOR



FINITURE | FINISHES





# N11

**IT**  
Armadio con anta battente  
Cutting, letto Verso,  
gruppo Leader.

**EN**  
Wardrobe with Cutting  
swing door, Verso bed,  
Leader set.











LETTO VERSO | VERSO BED

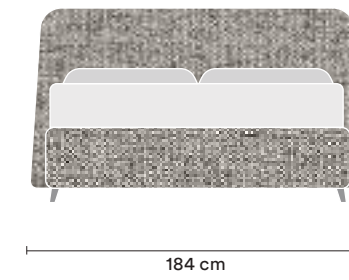

GRUPPO LEADER | LEADER SET

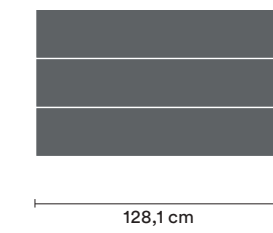

**comò** | chest of drawers  
P/D 55,6 H 79,2 cm

**comodino** | bedside unit  
P/D 45,6 H 47,2 cm

ARMADIO ANTA BATTENTE CUTTING | WARDROBE WITH CUTTING SWING DOOR

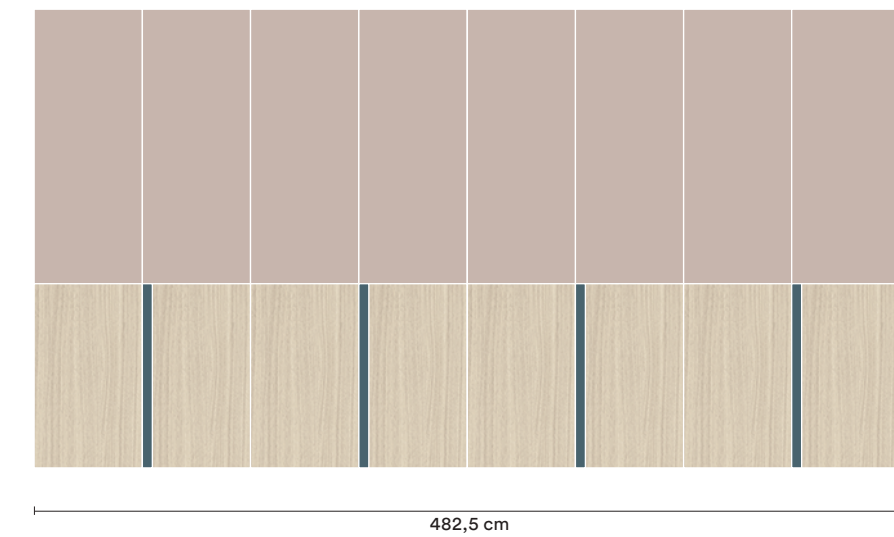

FINITURE | FINISHES

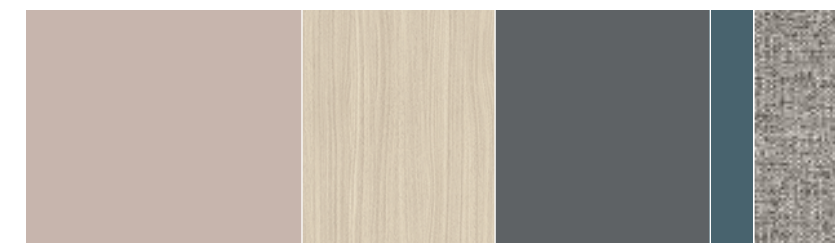

Canapa  
Noce naturale  
Grigio titanio  
Blu opale  
Kenya Taupe



# N12



**IT**  
 Armadio con anta battente Cutting plus e vano porta tv, letto Adagio, gruppo Leader, piano Podio e basi sospese con anta Club, cabina armadio.

**EN**  
 Wardrobe with Cutting plus swing door and TV housing space, Adagio bed, Leader set, Podio top and suspended base units with Club door, walk-in wardrobe.











**LETTO ADAGIO | ADAGIO BED**

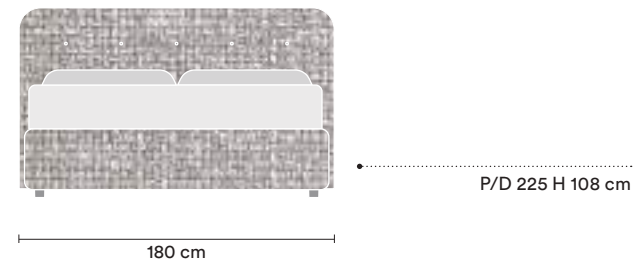

**GRUPPO LEADER | LEADER SET**

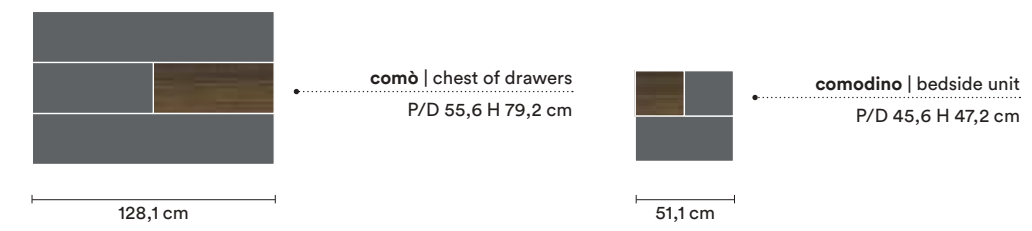

**ARMADIO ANTA BATTENTE CUTTING PLUS | WARDROBE WITH CUTTING PLUS SWING DOOR**

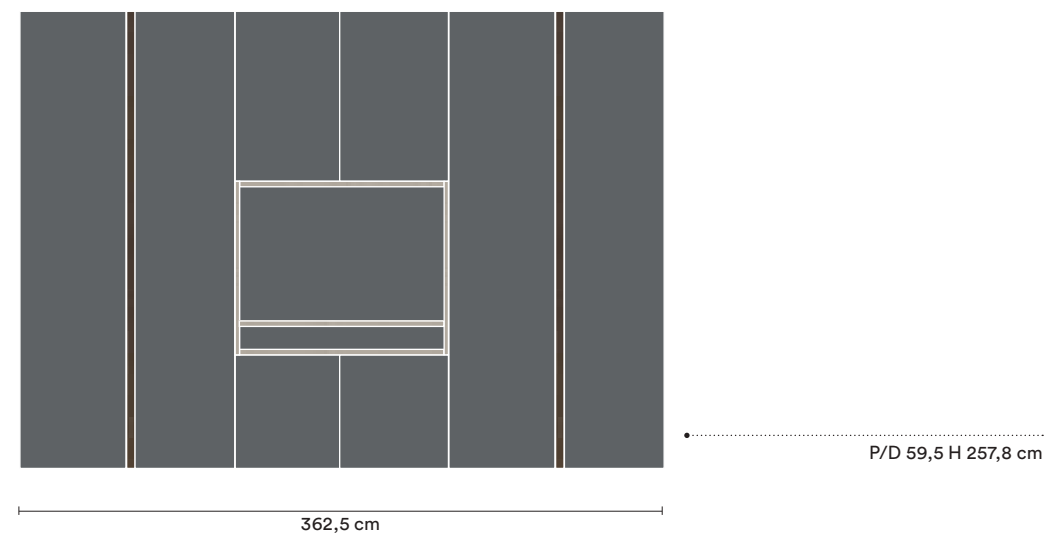

**CABINA ARMADIO | WALK IN CLOSET**

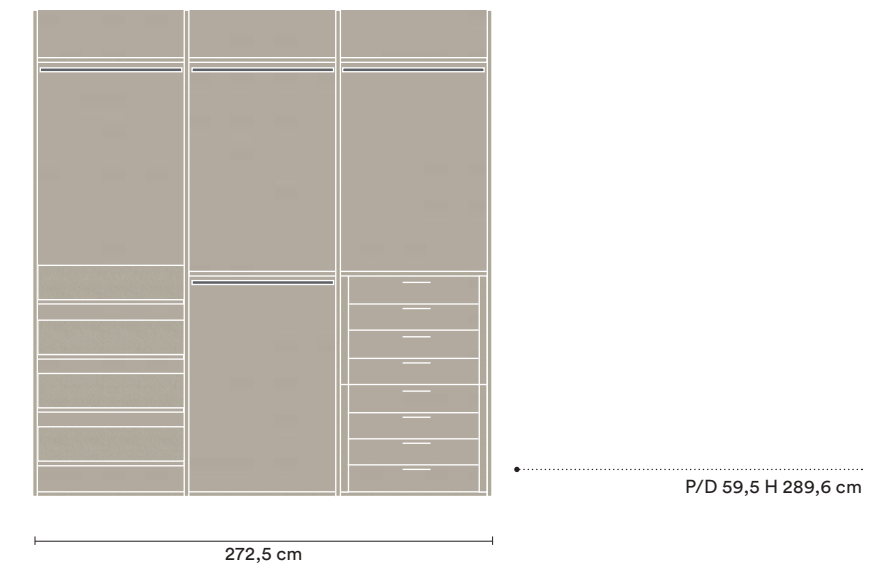

**PIANO PODIO E BASI SOSPESE | PODIO TOP AND SUSPENDED BASE UNITS**

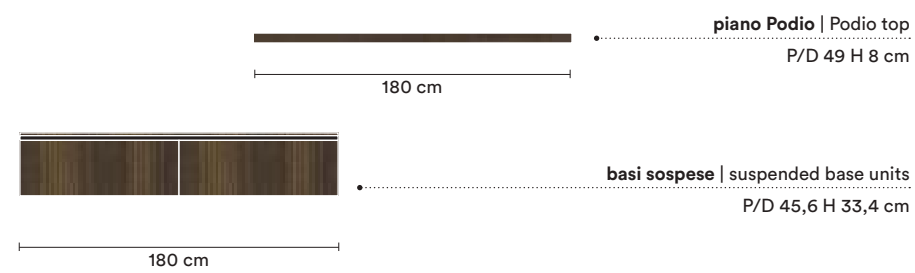

**FINITURE | FINISHES**

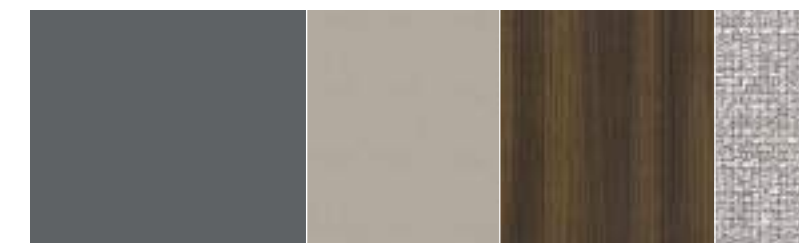

Grigio titanio  
Leather Grey  
Eucalipto  
Ecochic Dorian

# N13

**IT**  
Armadio con anta scorrevole Mosaico, letto Time e gruppo Look.

**EN**  
Wardrobe with Mosaico sliding door, Time bed and Look set.









LETTO TIME | TIME BED

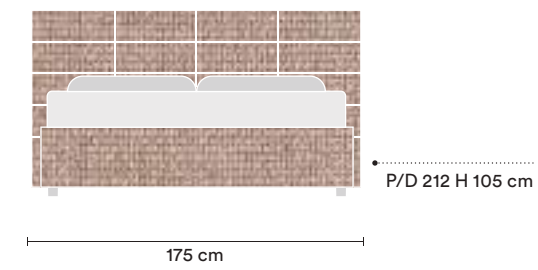

ARMADIO ANTA SCORREVOLE MOSAICO  
| WARDROBE WITH MOSAICO SLIDING DOOR

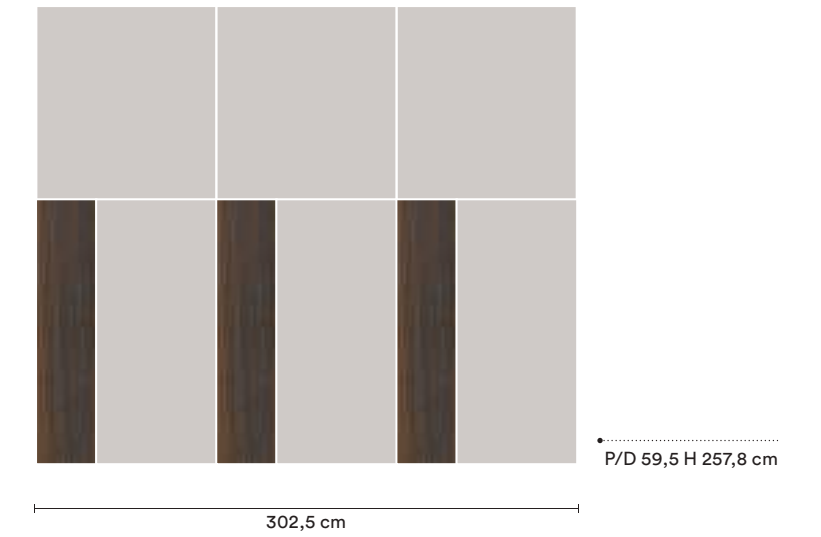

GRUPPO LOOK | LOOK SET

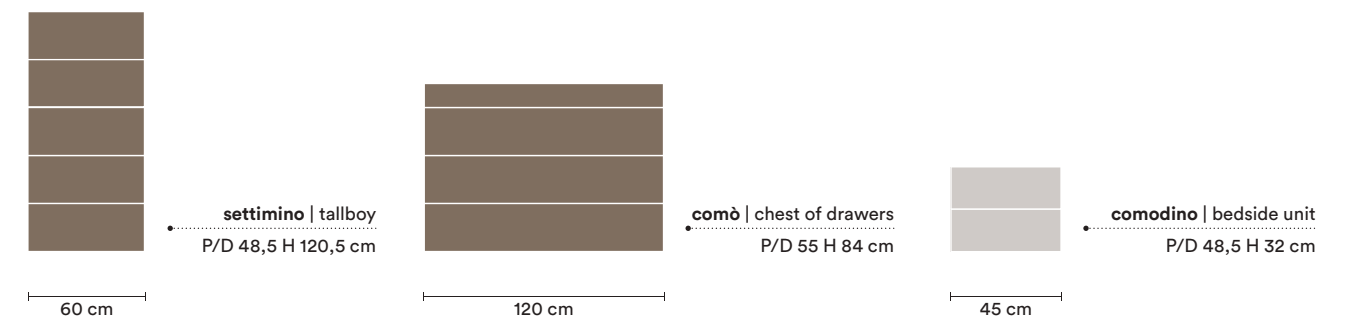

FINITURE | FINISHES

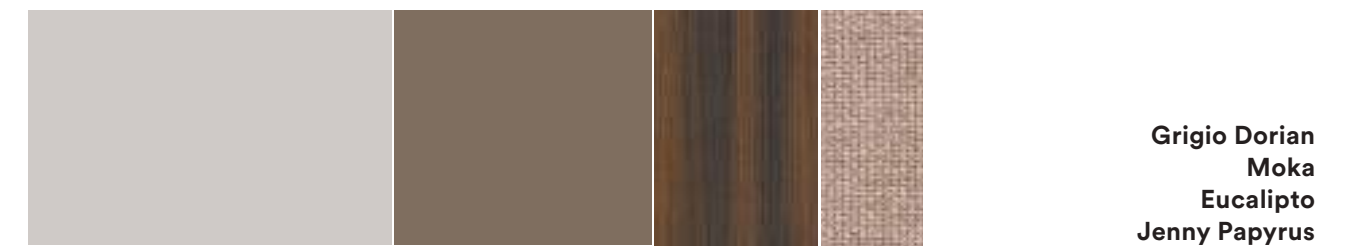



# N14

**IT**  
Armadio con anta scorrevole Mosaico, letto Adagio e gruppo Label.

**EN**  
Wardrobe with Mosaico sliding door, Adagio bed and Label set.







LETTO ADAGIO | ADAGIO BED

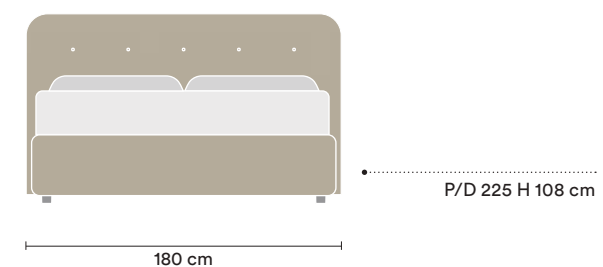

GRUPPO LABEL | LABEL SET

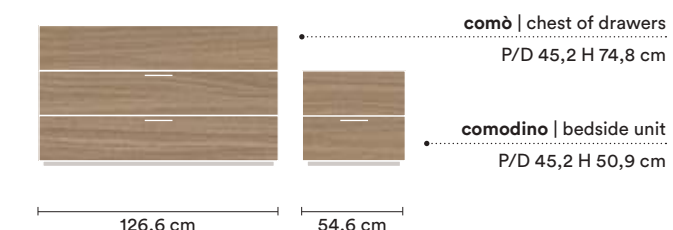

ARMADIO ANTA SCORREVOLE MOSAICO | WARDROBE WITH MOSAICO SLIDING DOOR

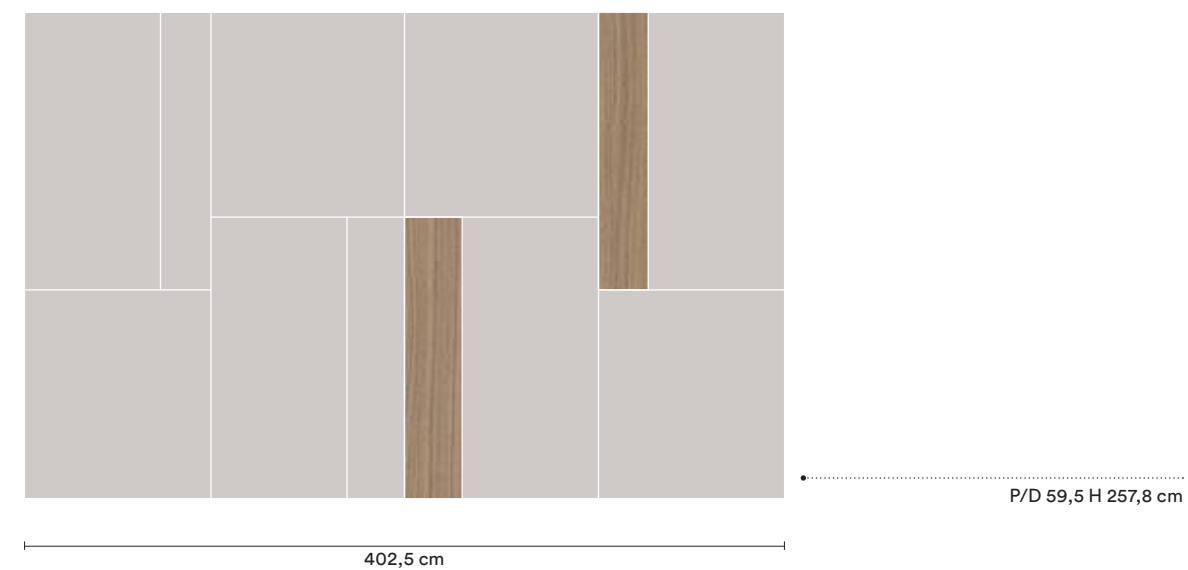

FINITURE | FINISHES

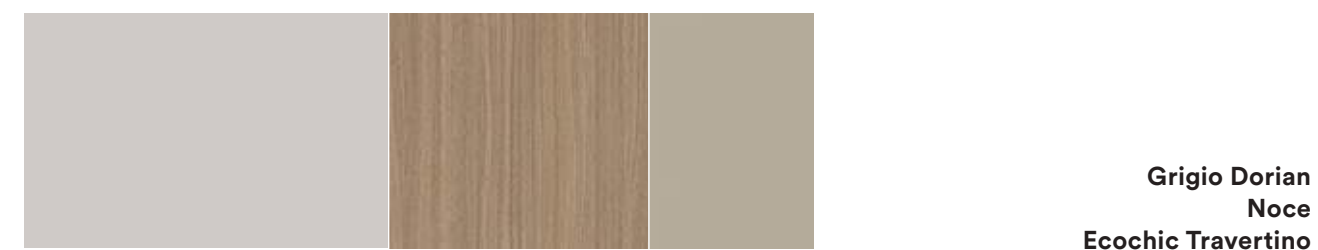

Grigio Dorian  
Noce  
Ecochic Travertino



# N15

**IT**  
Armadio con anta scorrevole Freedom, letto Tetris e gruppo Label.

**EN**  
Wardrobe with Freedom sliding door, Tetris bed and Label set.







LETTO TETRIS | TETRIS BED

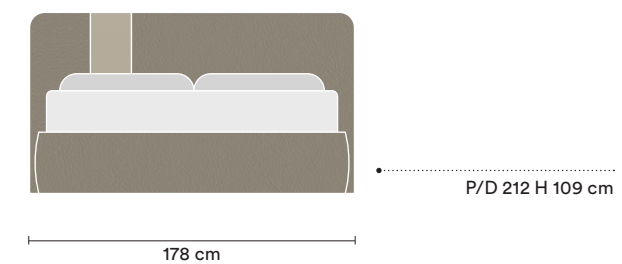

GRUPPO LABEL | LABEL SET

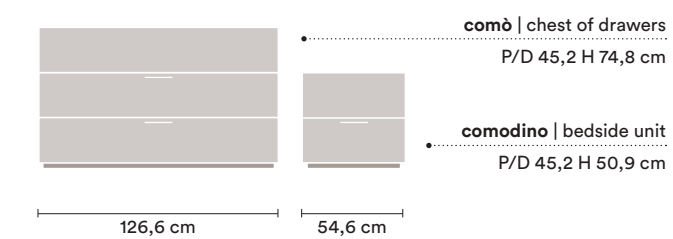

ARMADIO ANTA SCORREVOLE FREEDOM | WARDROBE WITH FREEDOM SLIDING DOOR

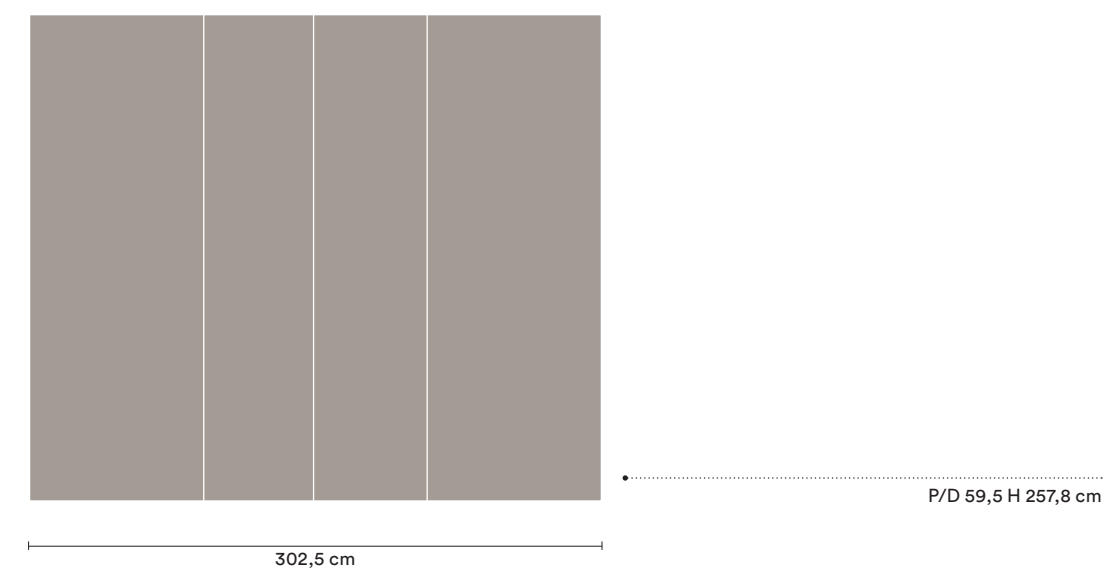

FINITURE | FINISHES





# N16

**IT**  
Armadio con anta scorrevole Mosaico, letto Kiss e gruppo Chic.

**EN**  
Wardrobe with Mosaico sliding door, Kiss bed and Chic set.











**LETTO KISS | KISS BED**

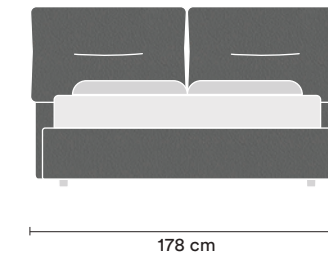

P/D 215 H 107 cm

**GRUPPO CHIC | CHIC SET**

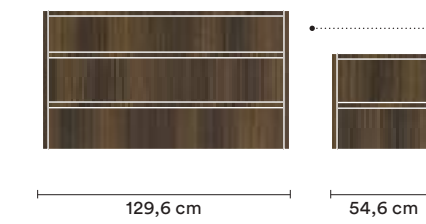

**comò | chest of drawers**  
P/D 54,5 H 74,7 cm

**comodino | bedside unit**  
P/D 45 H 50,5 cm

**ARMADIO ANTA SCORREVOLE MOSAICO | WARDROBE WITH MOSAICO SLIDING DOOR**



P/D 59,5 H 257,8 cm

302,5 cm

**FINITURE | FINISHES**

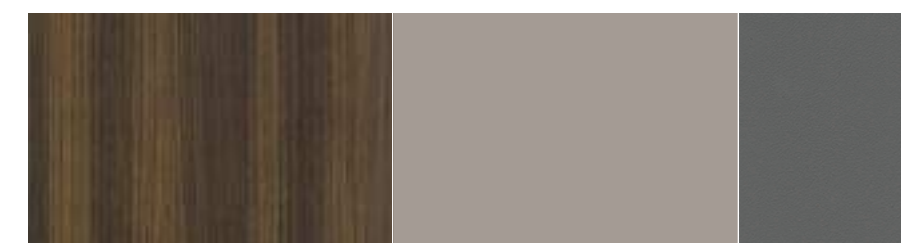

**Eucalipto**  
**Basalto**  
**Ecochic Elephant**



# N17

**IT**  
Armadio con anta scorrevole Freedom, letto Sector con giroletto Marte e gruppo Chic.

**EN**  
Wardrobe with Freedom sliding door, Sector bed with Marte bed frame and Chic set.









LETTO SECTOR | SECTOR BED

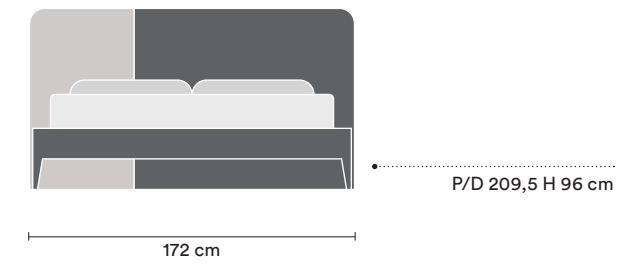

GRUPPO CHIC | CHIC SET

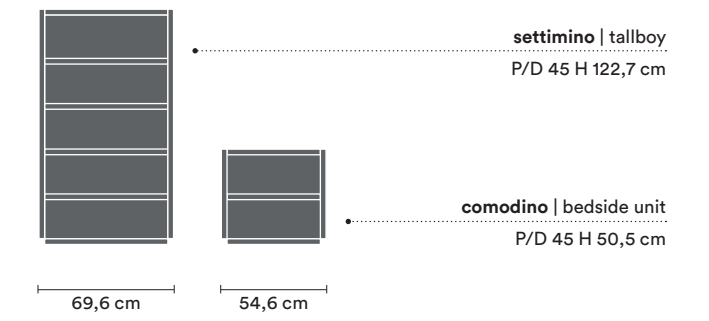

ARMADIO ANTA SCORREVOLE FREEDOM | WARDROBE WITH FREEDOM SLIDING DOOR

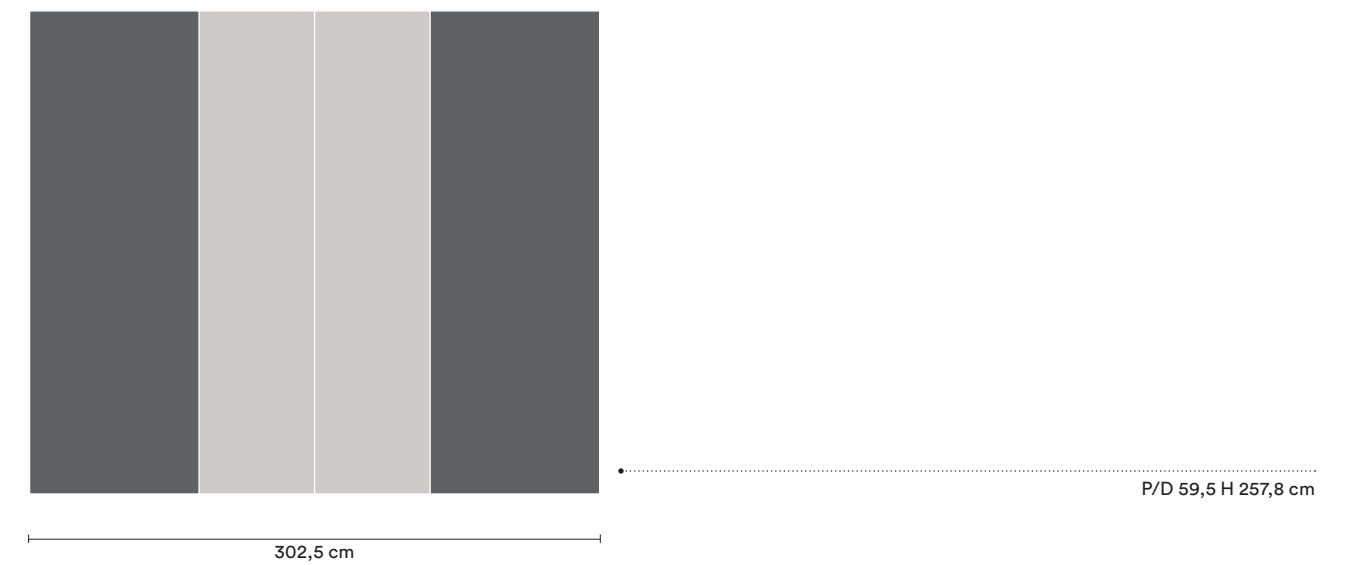

FINITURE | FINISHES





# N18

**IT**  
Armadio con anta scorrevole  
Rail, letto Adagio e gruppo  
Bold su piedini Nume.

**EN**  
Wardrobe with Rail sliding  
door, Adagio bed and Bold set  
on Nume feet.







LETTO ADAGIO | ADAGIO BED

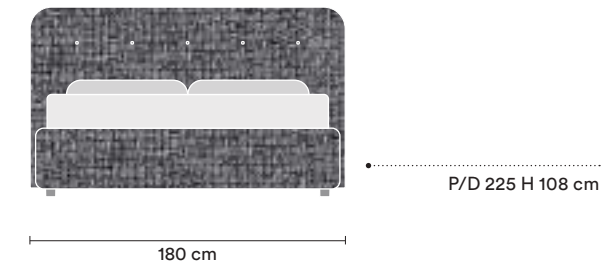

GRUPPO BOLD | BOLD SET

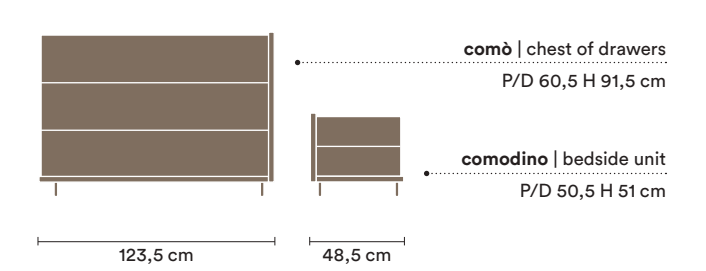

ARMADIO ANTA SCORREVOLE RAIL | WARDROBE WITH RAIL SLIDING DOOR

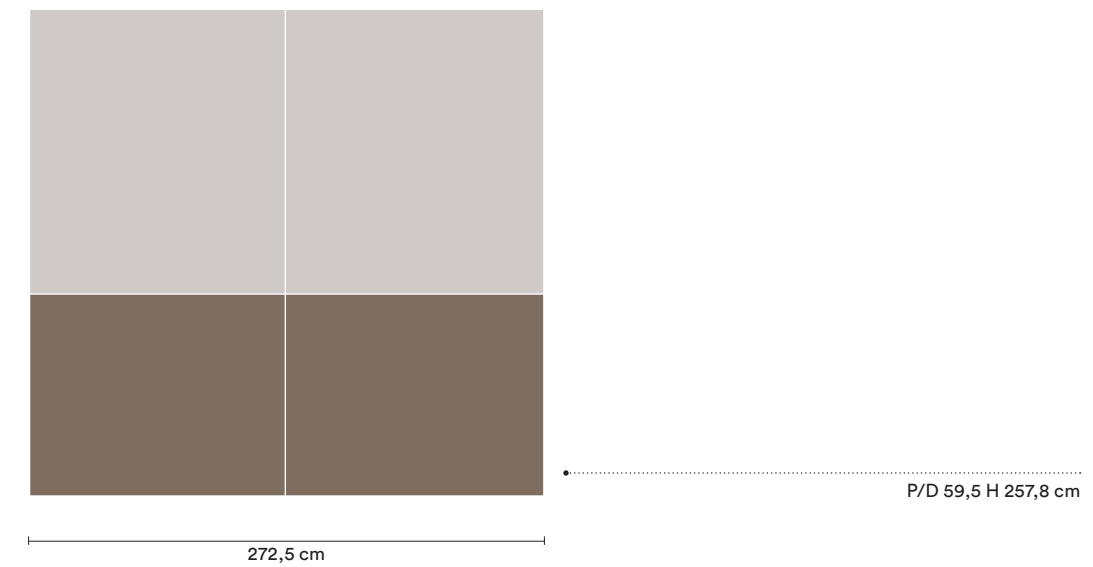

FINITURE | FINISHES

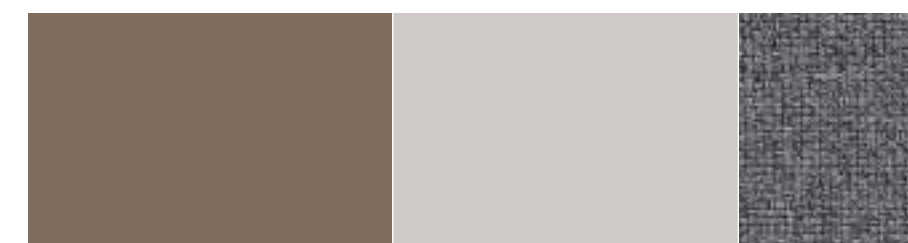

Moka  
Grigio Dorian  
Ecochic Titanio



# N19

**IT**  
 Armadio con anta battente One  
 e maniglia Bul, nicchia, ponte Rialto  
 e scrivania Podio, letto Cushy con  
 alloggiamento posteriore e giroletto  
Nettuno, gruppo Brick e panchetta Podio.

**EN**  
 Wardrobe with One swing door and  
Bul handle, niche, Rialto overhead  
 wardrobe and Podio desk, Cushy bed  
 with rear compartment and Nettuno  
 bed frame, Brick set and Podio bench.











LETTO CUSHY | CUSHY BED

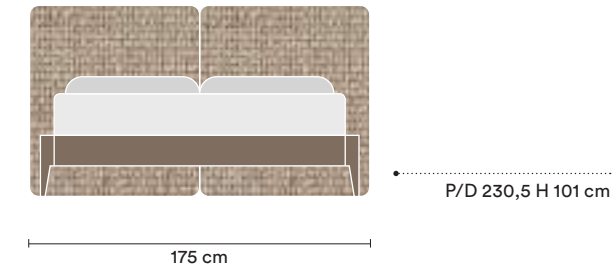

GRUPPO BRICK | BRICK SET

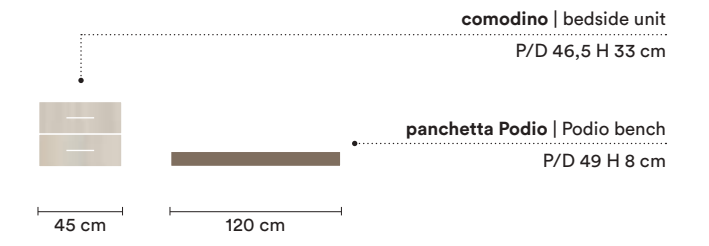

ARMADIO ANTA BATTENTE ONE | WARDROBE WITH ONE SWING DOOR

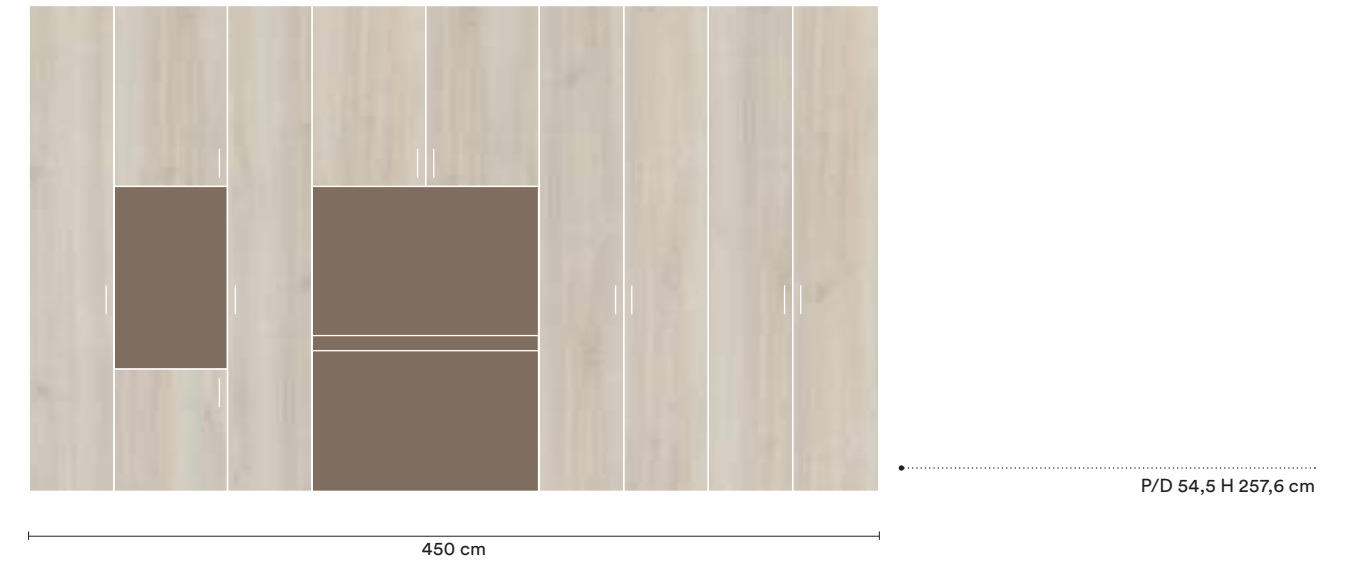

FINITURE | FINISHES



Ciliegio bianco  
Moka  
Jenny Papyrus

L'appartamento  
d'epoca tra ieri e oggi  
Il fascino di un  
tempo lontano  
rivive contaminato  
e valorizzato da una  
sensibilità moderna.  
Tra eleganza  
e funzionalità,  
tra atmosfera e vita.

The period apartment  
of past and present

The allure of a bygone era lives  
again, contaminated and enhanced  
by modern sensibility. Elegance  
and practicality, atmosphere and life.



# N20

Armadi nicchiati esaltano la zona notte rendendola protagonista assoluta. Tessili imbottiti valorizzano il pregio. Forme essenziali e tonalità tenui esprimono un'eleganza moderna, accogliente e delicata.

Niche wardrobes enhance the bedroom, making it the absolute protagonist. Upholstered textiles heighten their value. Understated forms and soft hues express modern, welcoming and gentle elegance.

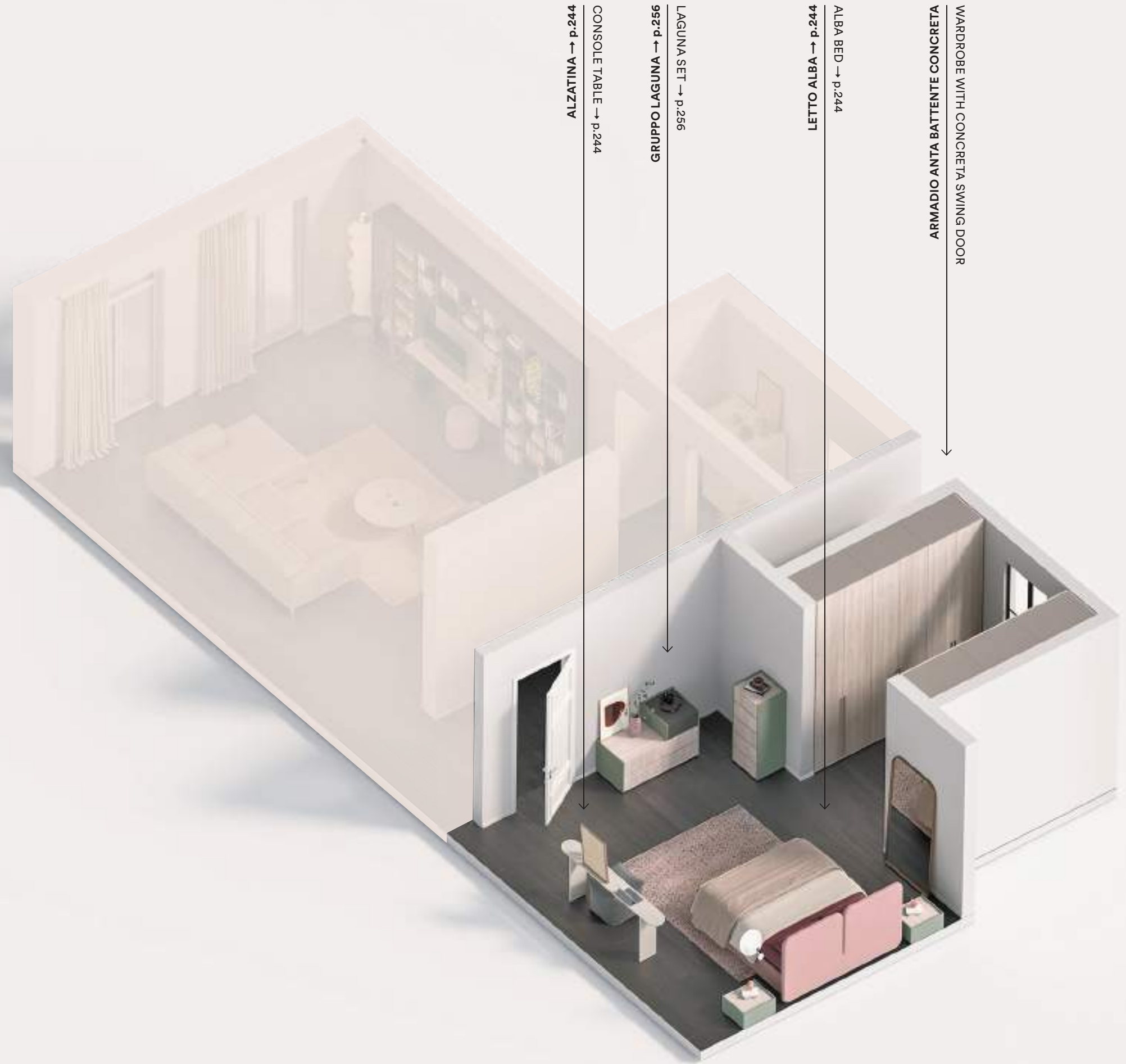

SCOPRI LE ALTRE COMPOSIZIONI → p.148

SEE THE OTHER COMPOSITIONS → p.148





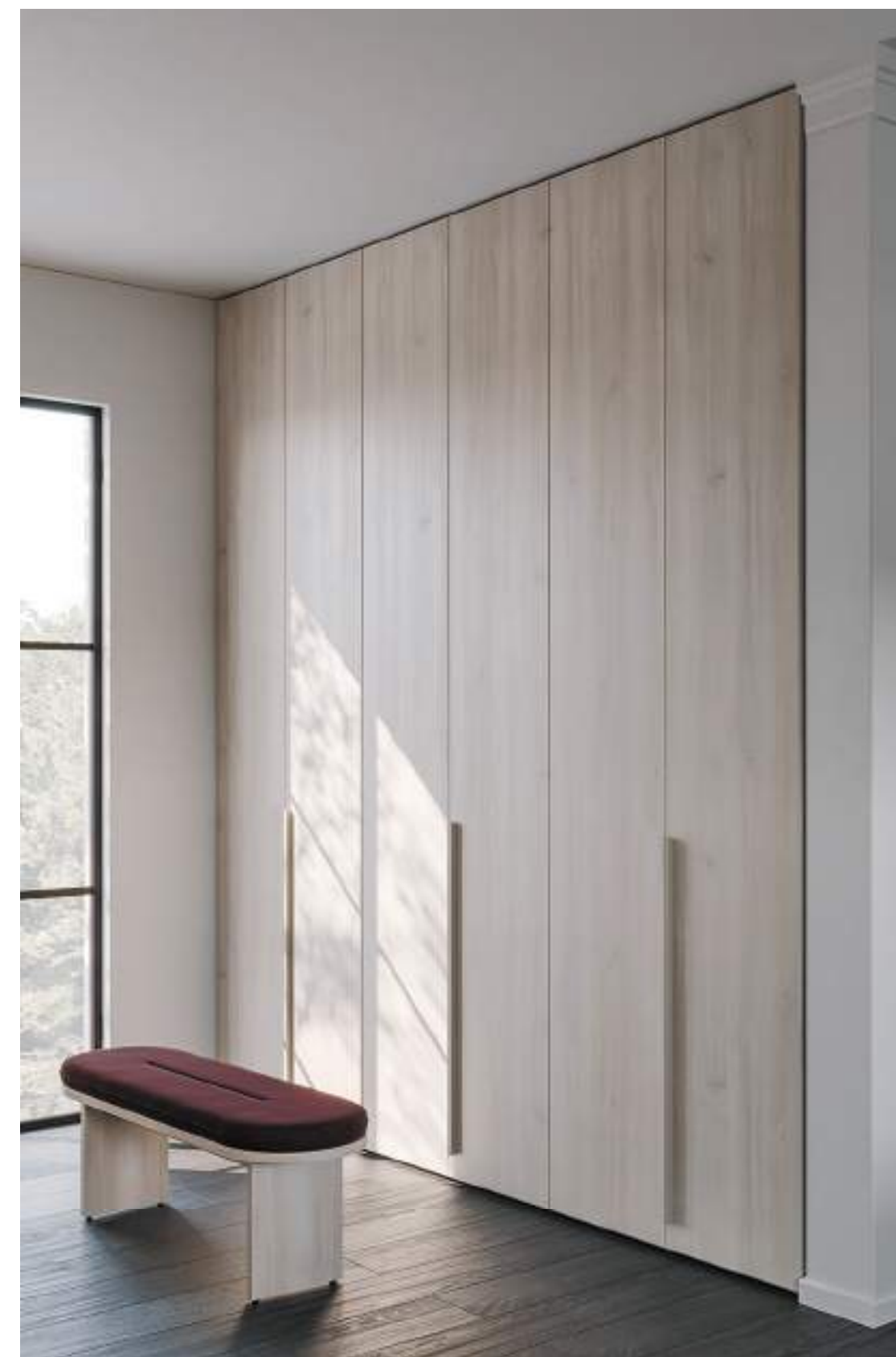



**IT**  
Armadio con anta battente Concreta e maniglia Pul, letto Alba, alzatina e panca fondo letto, gruppo Laguna.

**EN**  
Wardrobe with Concreta swing door and Pul handle, Alba bed, console table and end-of-bed bench, Laguna set.





**LETTO ALBA | ALBA BED**

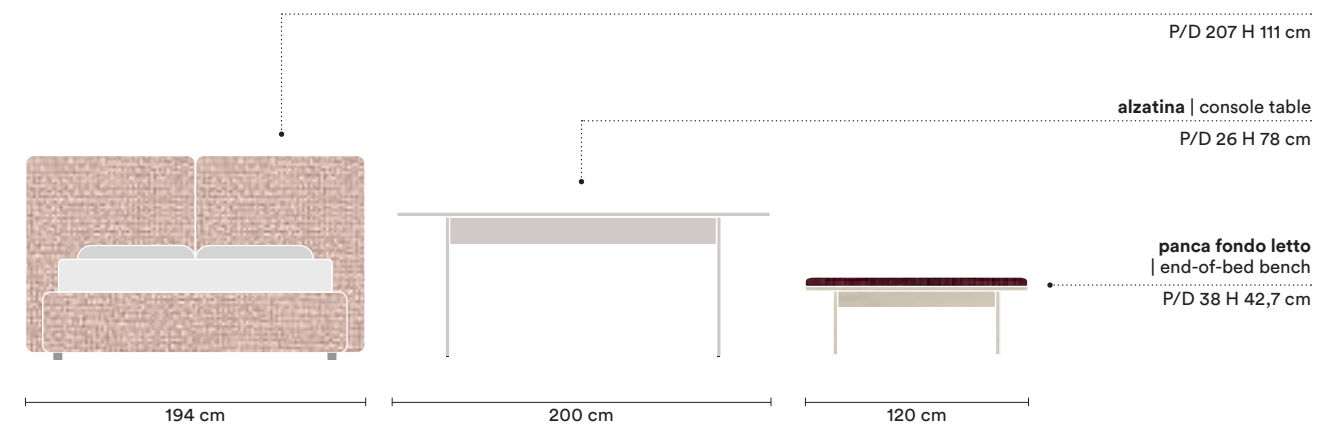

**ARMADIO ANTA BATTENTE CONCRETA  
| WARDROBE WITH CONCRETA SWING DOOR**

**GRUPPO LAGUNA | LAGUNA SET**



**FINITURE | FINISHES**

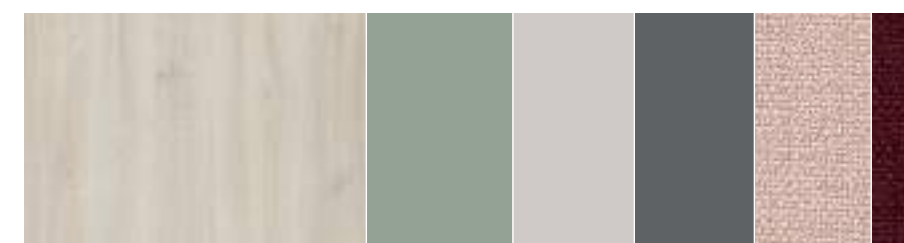

- Ciliegio bianco
- Agave
- Grigio Dorian
- Grigio titanio
- Jenny Pill
- Jenny Bombay



# N21

**IT**  
Armadio con anta battente Concreta, cabina e maniglia Pul, letto Twin e componibili sospesi, gruppo Quadro.

**EN**  
Wardrobe with Concreta swing door, walk-in and Pul handle, Twin bed and suspended modular elements, Quadro set.













**LETTO TWIN | TWIN BED**

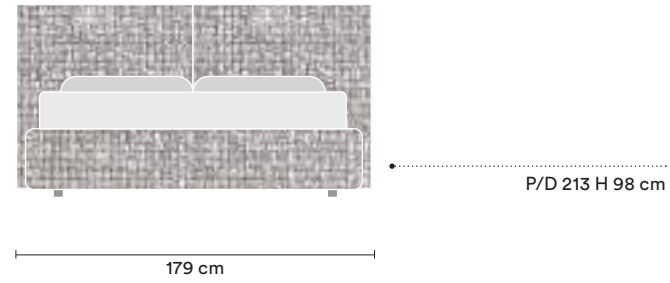

**GRUPPO QUADRO | QUADRO SET**

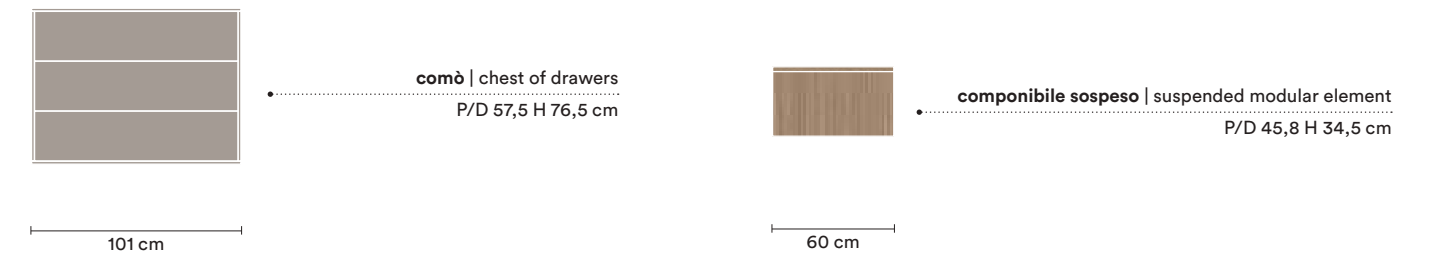

**ARMADIO ANTA BATTENTE CONCRETA E CABINA ARMADIO  
| WARDROBE WITH CONCRETA SWING DOOR AND WALK-IN**

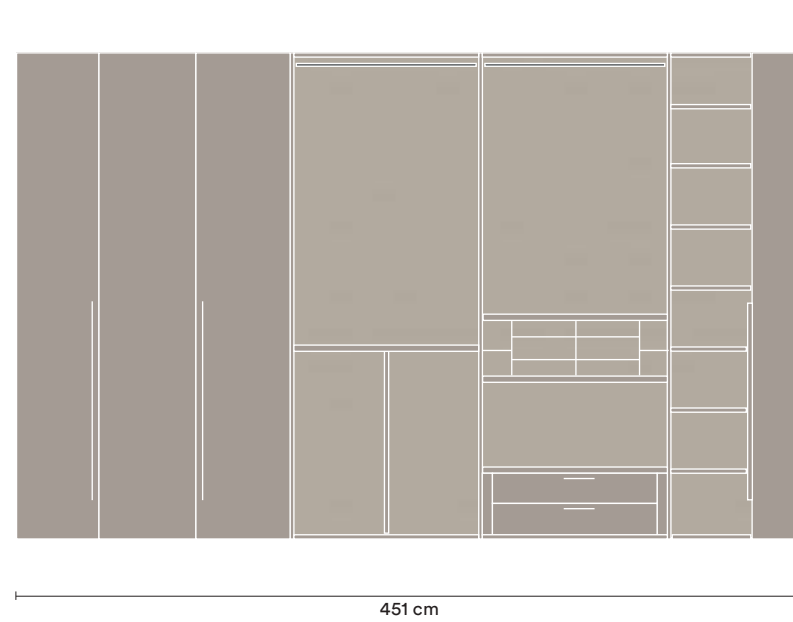

**CABINA ARMADIO E ARMADIO ANTA BATTENTE CONCRETA  
| WALK-IN AND WARDROBE WITH CONCRETA SWING DOOR**

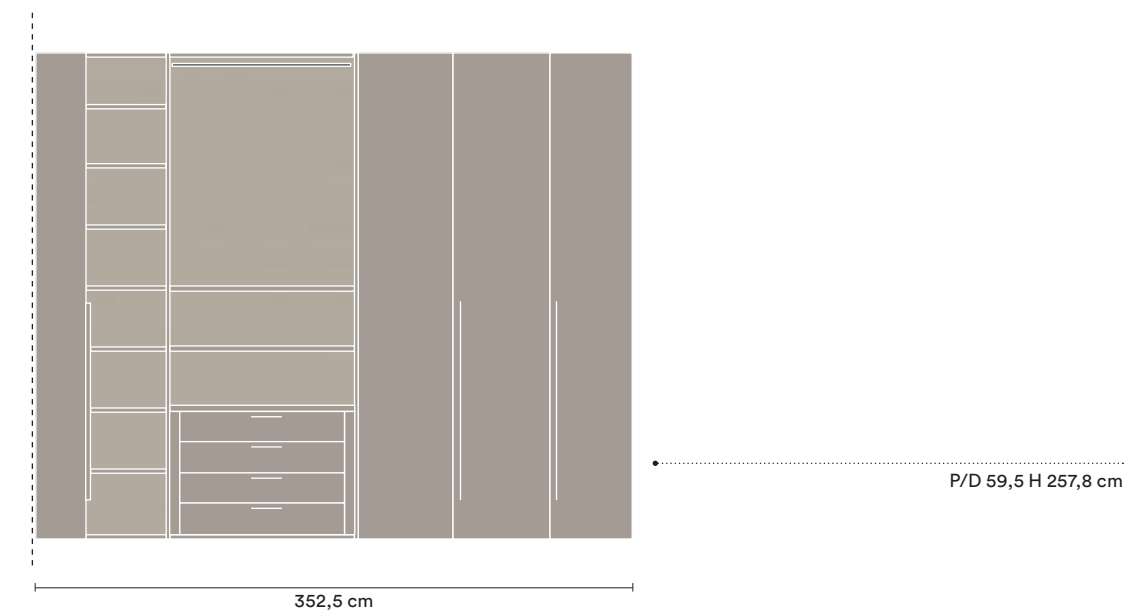

**FINITURE | FINISHES**

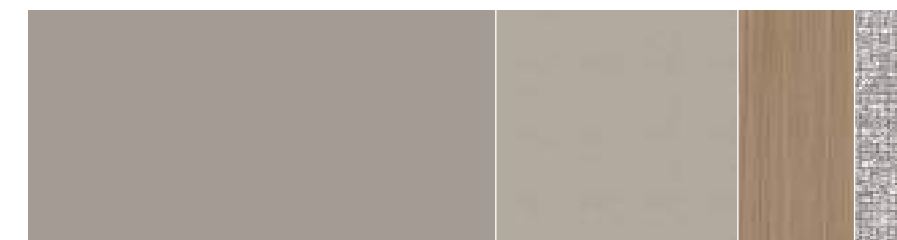

Basalto  
Leather grey  
Noce  
Ecochic Dorian

# N22

**IT**  
Armadio con anta scorrevole Concreta e maniglia Pul, letto Snug, gruppo Label e panca fondo letto.

**EN**  
Wardrobe with Concreta sliding door and Pul handle, Snug bed, Label set and end-of-bed bench.









**LETTO SNUG | SNUG BED**

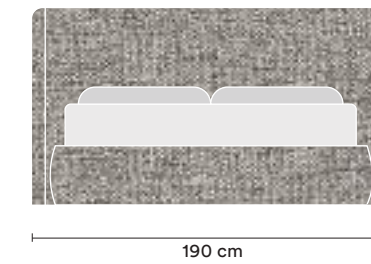

P/D 208 H 104,5 cm

**GRUPPO LABEL | LABEL SET**

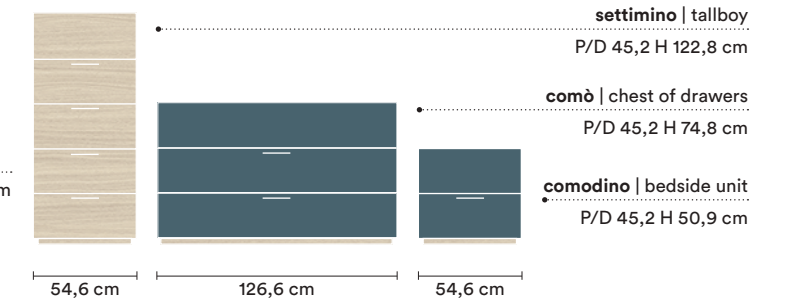

**settimino | tallboy**  
P/D 45,2 H 122,8 cm

**comò | chest of drawers**  
P/D 45,2 H 74,8 cm

**comodino | bedside unit**  
P/D 45,2 H 50,9 cm

**ARMADIO ANTA SCORREVOLE CONCRETA | WARDROBE WITH CONCRETA SLIDING DOOR**

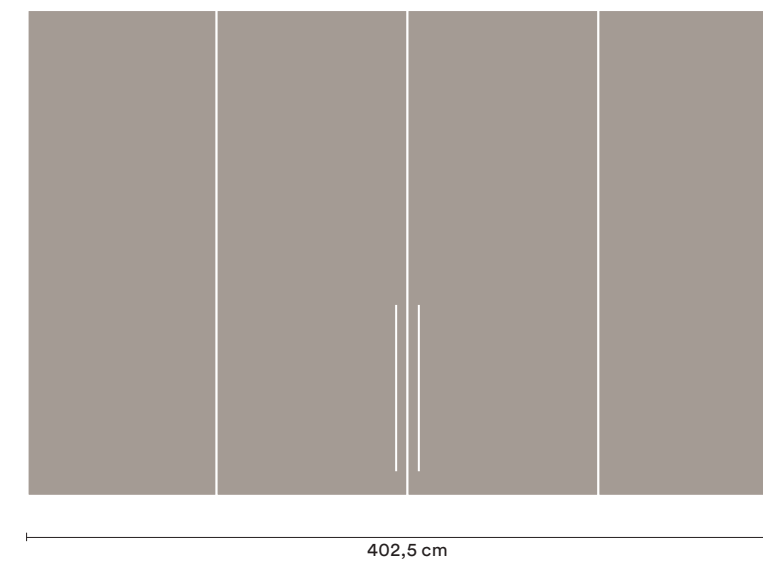

P/D 59,5 H 257,8 cm

**panca fondo letto | end-of-bed bench**  
P/D 38 H 42,7 cm

120 cm

**FINITURE | FINISHES**

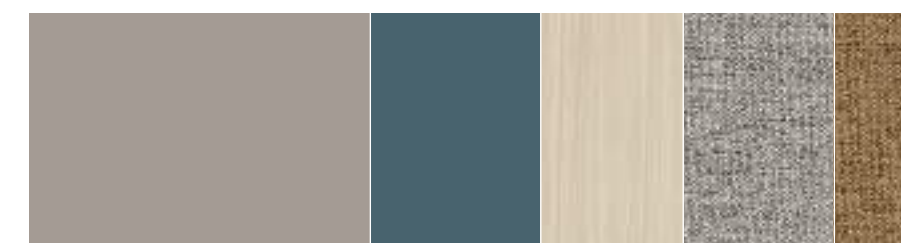

**Basalto**  
**Blu opale**  
**Noce naturale**  
**Kenya Taupe**  
**Kenya Camel**



# N23

**IT**  
 Armadio con anta battente Concreta,  
 nicchia e maniglia Ines, armadio per  
 passaggio, letto Unique, gruppo Leader,  
 piano Podio e mensole.

**EN**  
 Wardrobe with Concreta swing door,  
 niche and Ines handle, over-door  
 wardrobe, Unique bed, Leader set,  
Podio top and shelves.









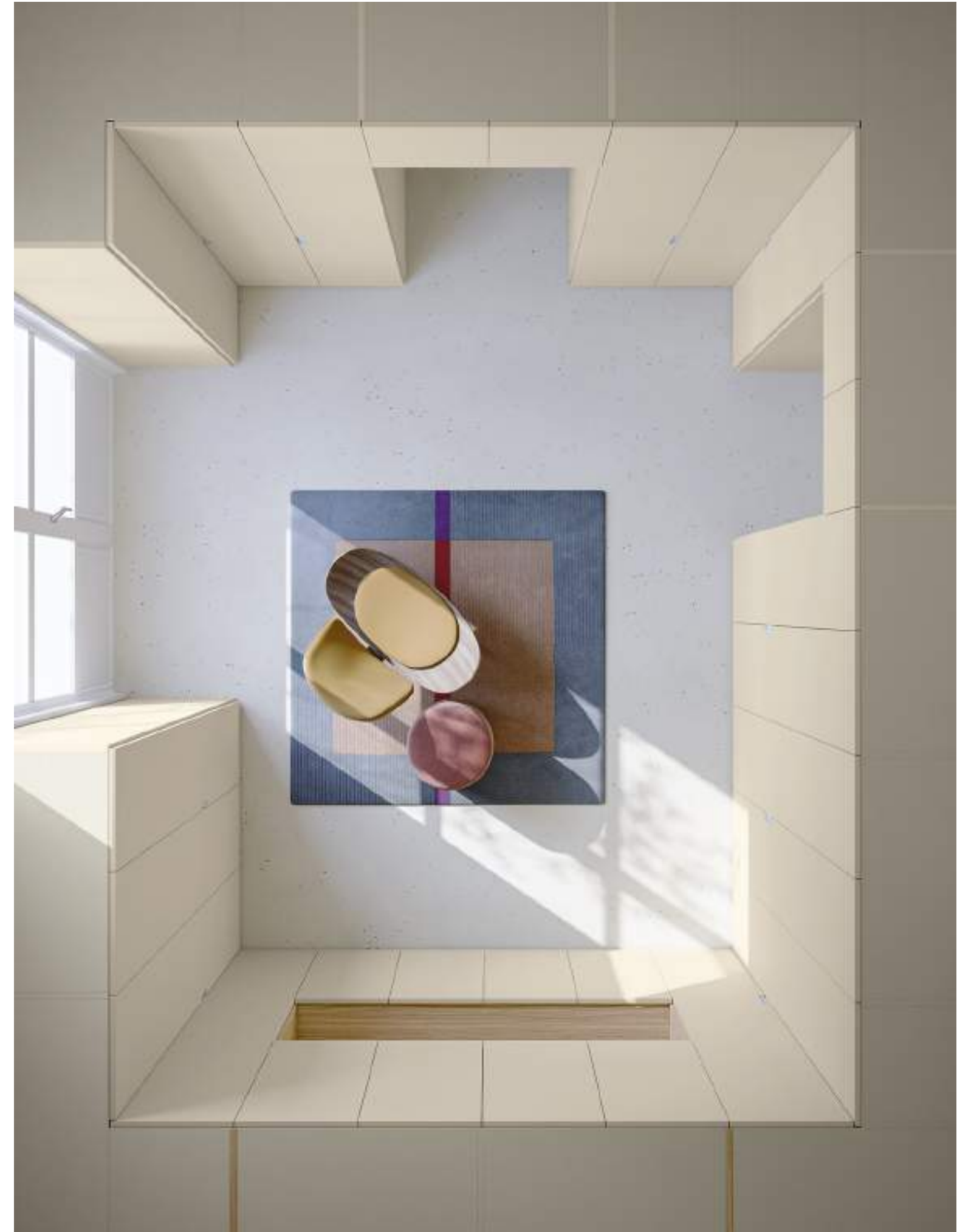

**LETTO UNIQUE | UNIQUE BED**

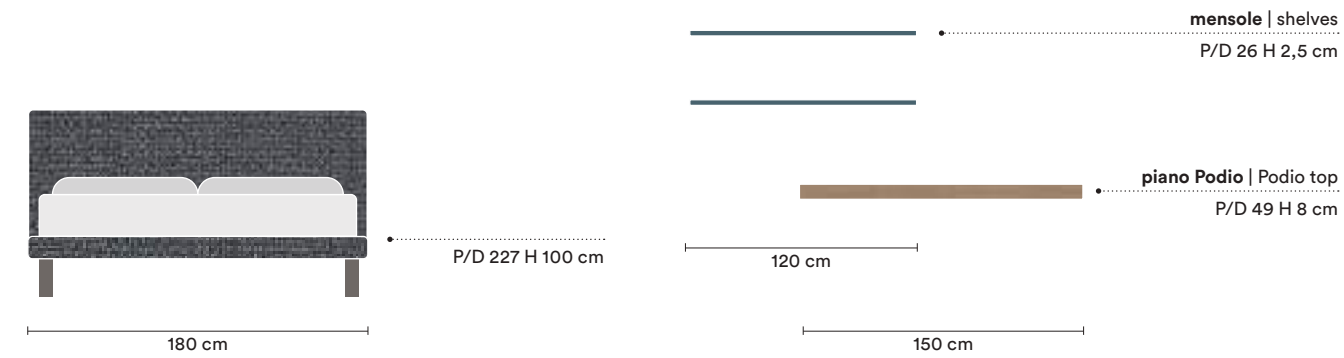

**GRUPPO LEADER | LEADER SET**



**ARMADIO ANTA BATTENTE CONCRETA | WARDROBE WITH CONCRETA SWING DOOR**

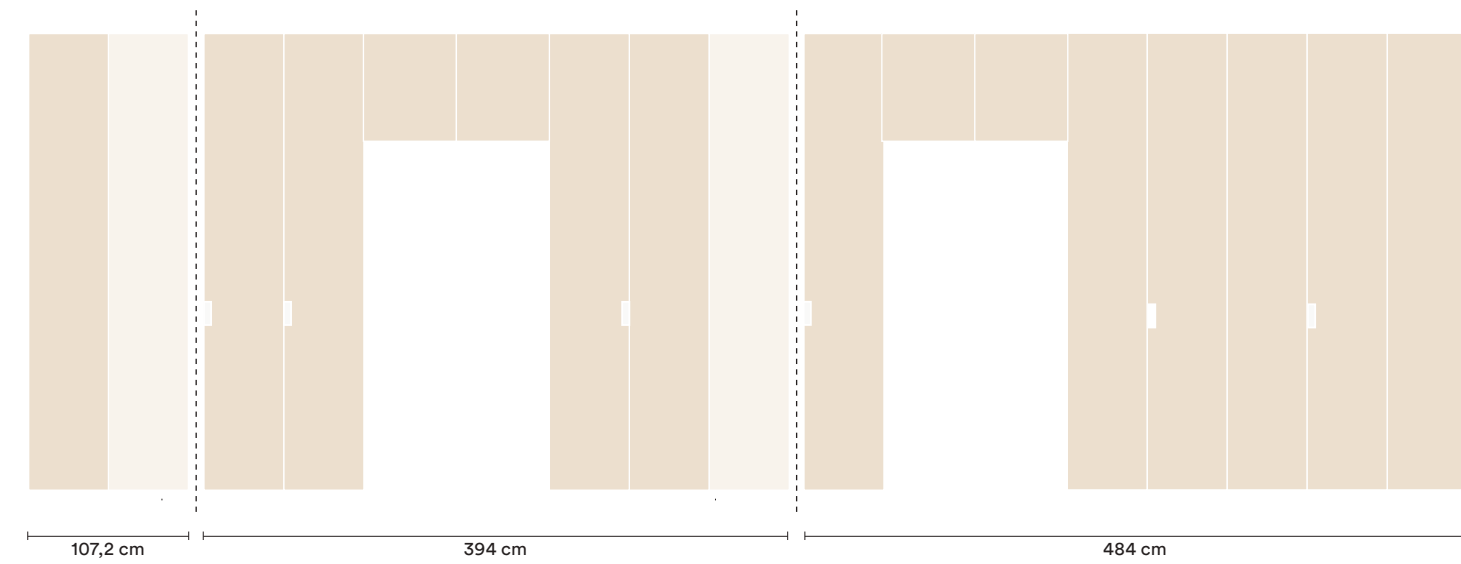

**ARMADIO ANTA BATTENTE CONCRETA CON NICCHIA | WARDROBE WITH CONCRETA SWING DOOR AND NICHE**

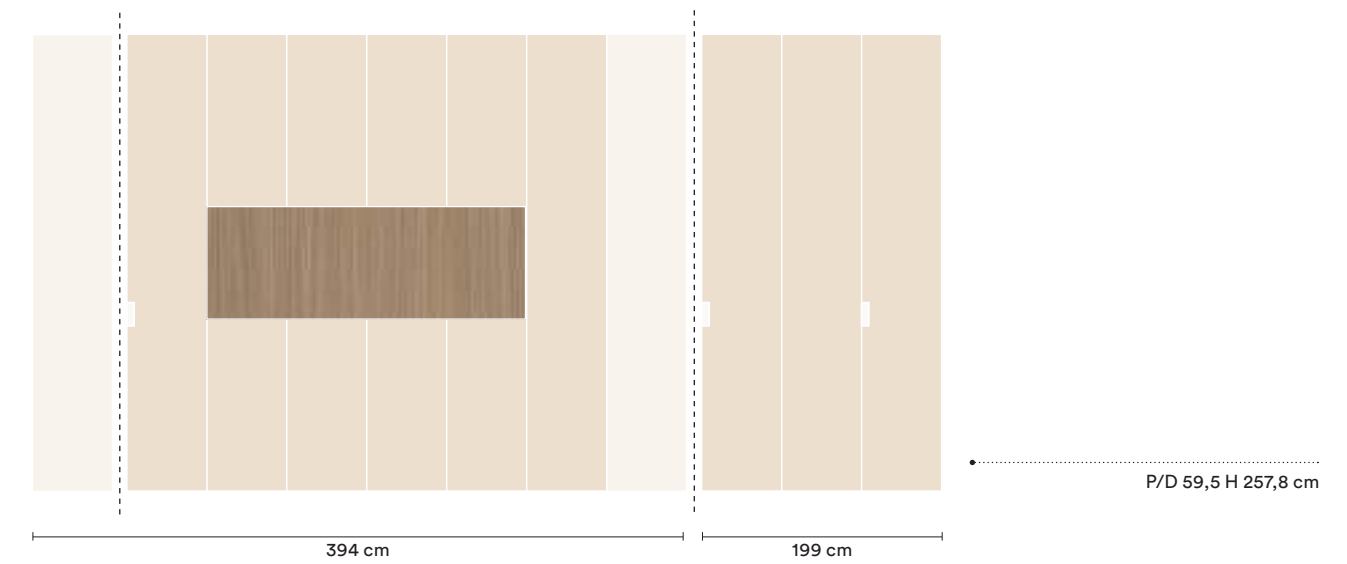

**FINITURE | FINISHES**



Desert  
Noce  
Blu opale  
Jenny Smoke



# N24

**IT**  
Armadio battente con anta Club.  
Letto Mushy con alloggiamento  
posteriore e giroletto Marte.  
Gruppo Bold su piedini Nume.

**EN**  
Swing wardrobe with Club  
door. Mushy bed with rear  
compartment and Marte bed  
frame. Bold set on Nume feet.









## LETTO MUSHY | MUSHY BED

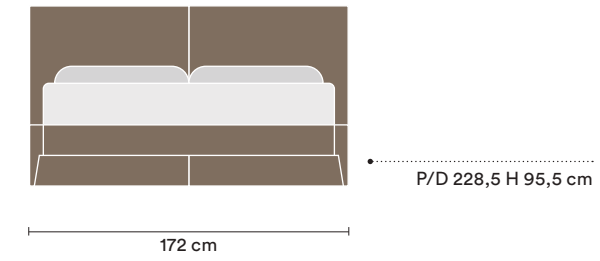

## GRUPPO BOLD | BOLD SET

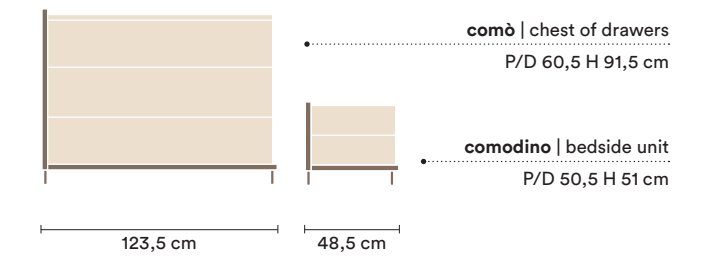

## ARMADIO ANTA BATTENTE CLUB | WARDROBE WITH CLUB SWING DOOR

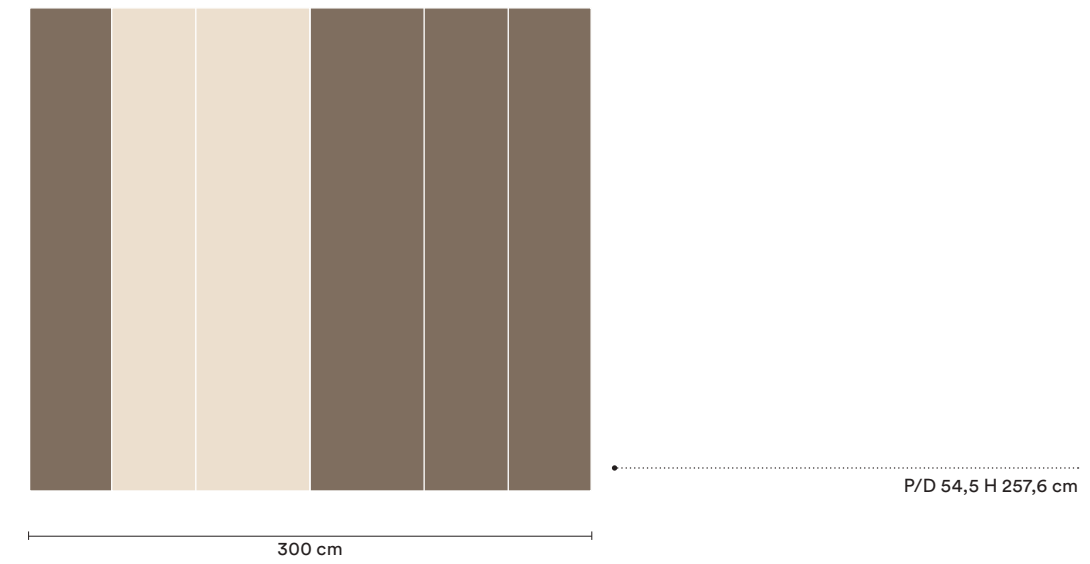

## FINITURE | FINISHES



**Moka  
Desert**

# N25

**IT**  
Armadio con anta battente  
Concreta e consolle,  
letto Virgo con giroletto  
Marte, gruppo Label.

**EN**  
Wardrobe with Concreta  
swing door and console,  
Virgo bed with Marte  
bed frame, Label set.









**LETTO VIRGO | VIRGO BED**



P/D 209,5 H 100 cm

177,5 cm

**GRUPPO LABEL | LABEL SET**



**comò | chest of drawers**  
P/D 45,2 H 74,8 cm

**comodino | bedside unit**  
P/D 45,2 H 50,9 cm

126,6 cm

54,6 cm

**ARMADIO ANTA BATTENTE CONCRETA CON CONSOLLE**  
| WARDROBE WITH CONCRETA SWING DOOR AND CONSOLE

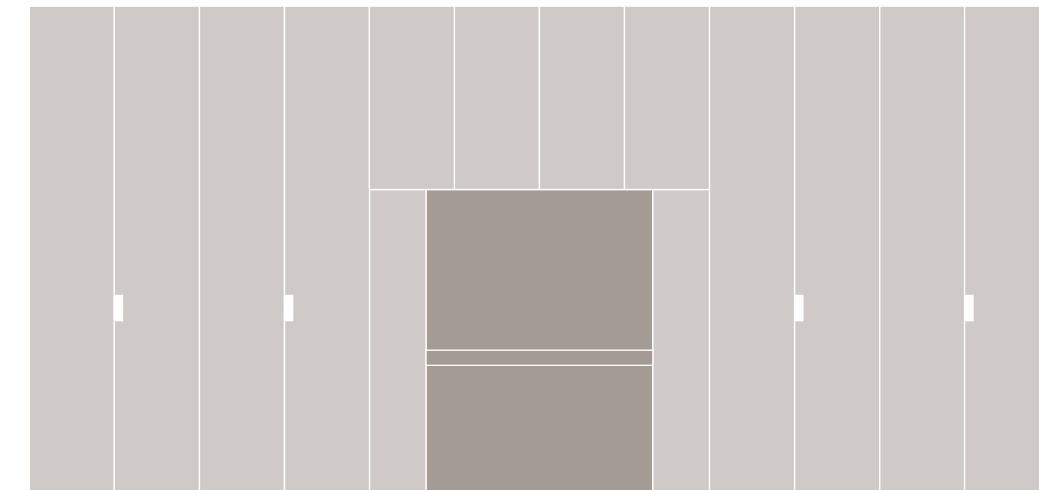

P/D 59,5 H 257,8 cm

543 cm

**FINITURE | FINISHES**



**Grigio Dorian**  
**Basalto**



# N26

**IT**  
Armadio con anta battente One,  
maniglia Bul e cassetti Club, letto  
Sector con giroletto Marte  
e gruppo Brick con pomello Pin.

**EN**  
Wardrobe with One swing door,  
Bul handle and Club drawers,  
Sector bed with Marte bed frame  
and Brick set with Pin knob.









LETTO SECTOR | SECTOR BED

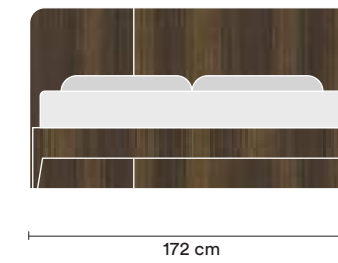

P/D 210 H 96 cm

GRUPPO BRICK | GRUPPO BRICK

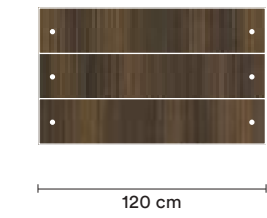

comò | chest of drawers  
P/D 57 H 73 cm

comodino | bedside unit  
P/D 46,5 H 33 cm

ARMADIO ANTA BATTENTE ONE CON CASSETTI CLUB  
| WARDROBE WITH ONE SWING DOOR AND CLUB DRAWERS

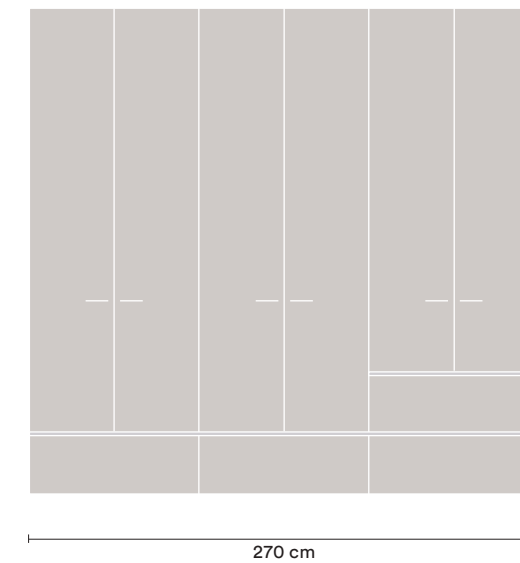

P/D 54,5 H 257,6 cm

FINITURE | FINISHES

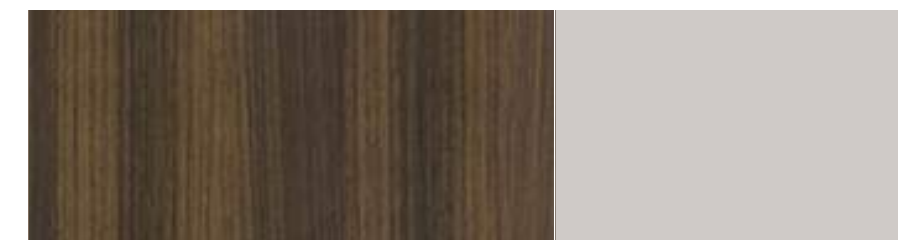

Eucalipto  
Grigio Dorian

# N27

**IT**  
 Armadio con anta battente One, nicchie e pomello Pin,  
 letto Reverso con piedini  
 in plexiglass e gruppo Gape  
 su piedini Epsilon.

**EN**  
 Wardrobe with One swing  
 door, niches and Pin knob,  
Reverso bed with plexiglass feet  
 and Gape set on Epsilon feet.









Variante compositiva | Composition variant

**IT**  
Armadio con anta battente **One** e maniglia **Bul**, nicchia e modulo porta tv.

**EN**  
Wardrobe with **One** swing door and **Bul** handle, niche and TV panel module.





**LETTO REVERSO | REVERSO BED**

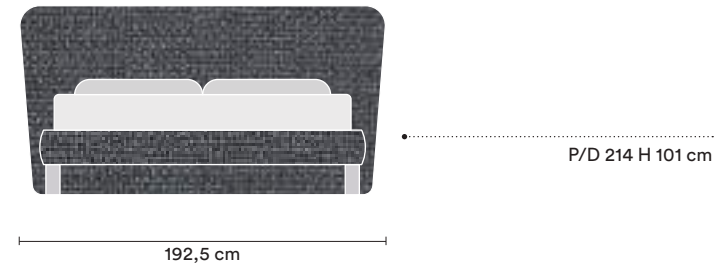

**GRUPPO GAPE | GAPE SET**

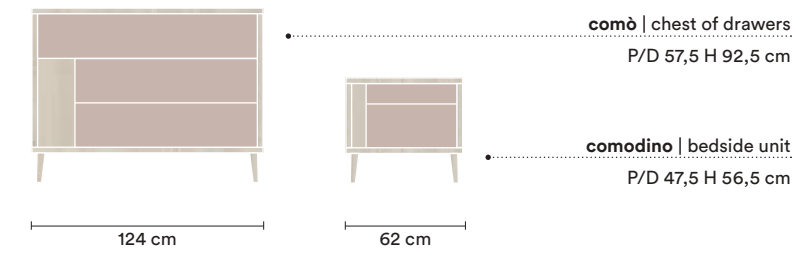

**ARMADIO ANTA BATTENTE ONE CON NICCHIE  
| WARDROBE WITH ONE SWING DOOR AND NICHE**

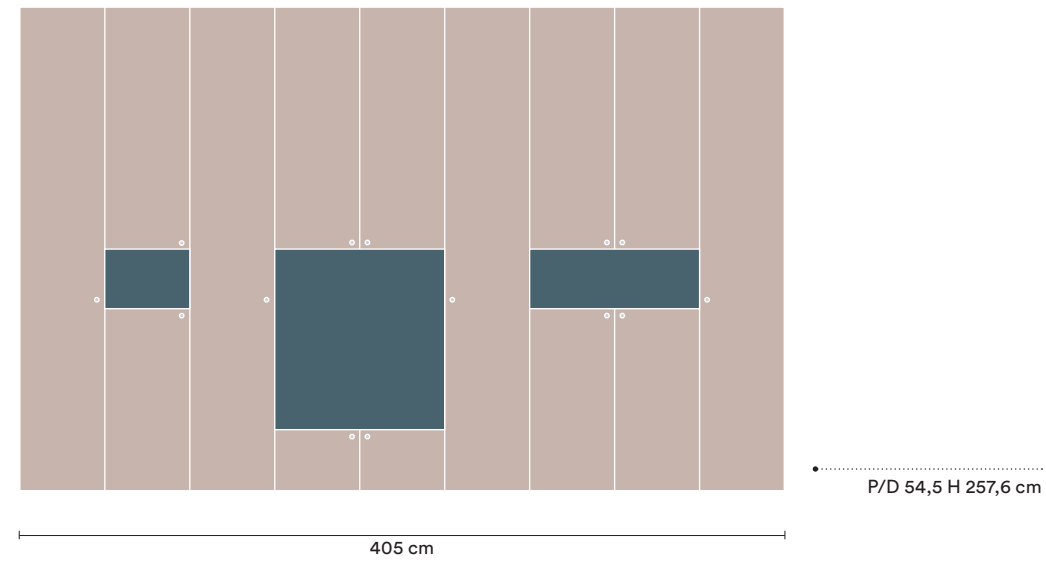

**ARMADIO ANTA BATTENTE ONE CON NICCHIE E PORTA TV  
| WARDROBE WITH ONE SWING DOOR, NICHE AND TV PANEL MODULE**

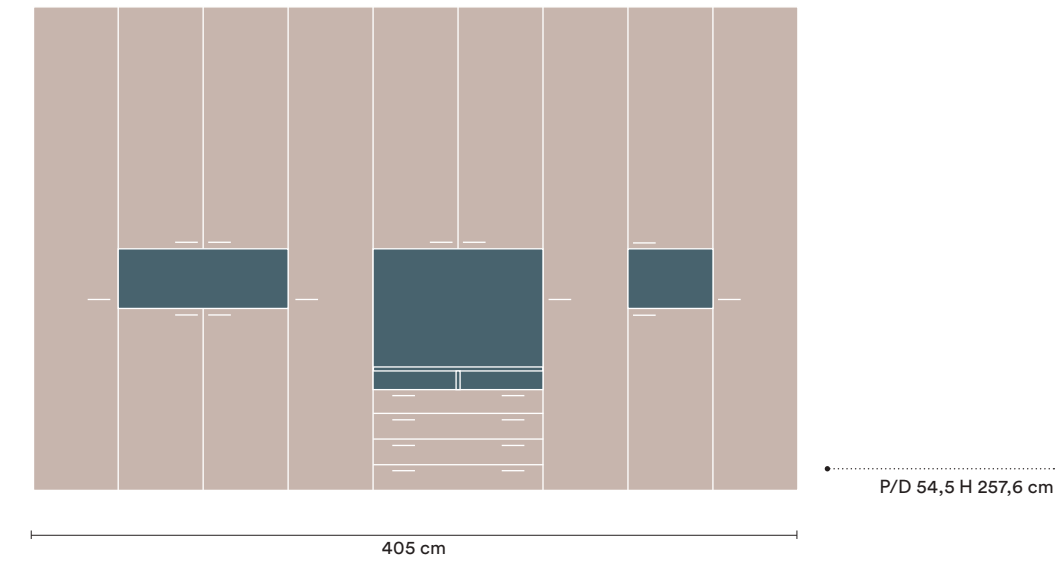

**FINITURE | FINISHES**



Canapa  
Blu opale  
Ciliegio bianco  
Jenny Smoke





# N28

Una camera di dimensioni esigue: la libreria che separa, ritma e di nuovo connette. Dal letto all'armadio agli altri componenti di arredo: la creatività orchestra lo spazio con uno stile essenziale.

A modest-sized bedroom: the bookshelf that separates, adds rhythm and then reconnects. From the bed to the wardrobe to all the other furnishings: creativity orchestrates the space in essential style.



SCOPRI LE ALTRE COMPOSIZIONI → p.208

SEE THE OTHER COMPOSITIONS → p.208







**IT**

Libreria Infinity a terra in contropinta con porta tv girevole e anta battente One, armadio con anta battente Concreta e maniglia Ines, letto Line, gruppo Look.

**EN**

Infinity floor-standing counter-opposing bookshelf with swivel TV stand and One swing door, wardrobe with Concreta swing door and Ines handle, Line bed, Look set.









LETTO LINE | LINE BED

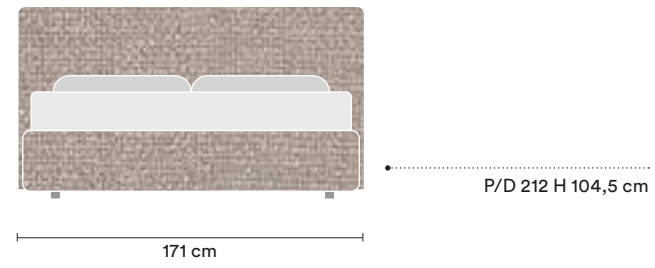

ARMADIO ANTA BATTENTE CONCRETA | WARDROBE WITH CONCRETA SWING DOOR

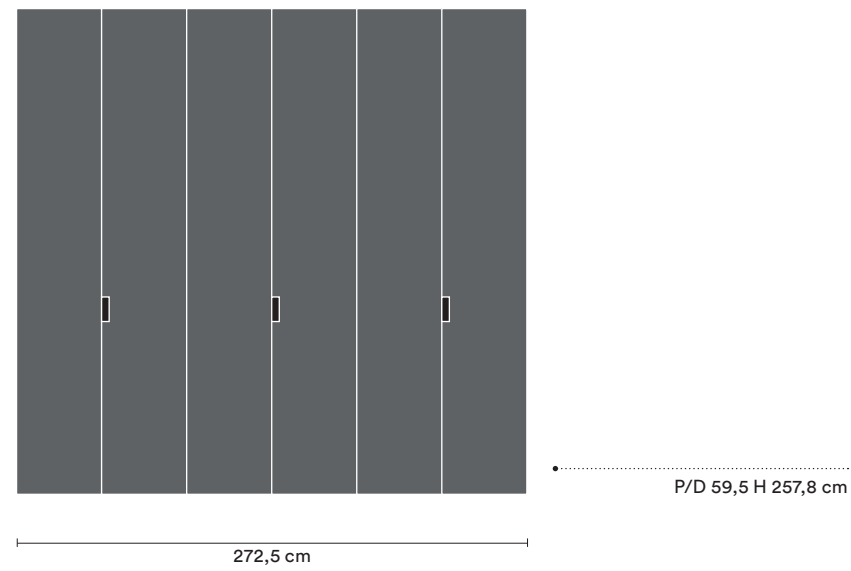

GRUPPO LOOK | LOOK SET

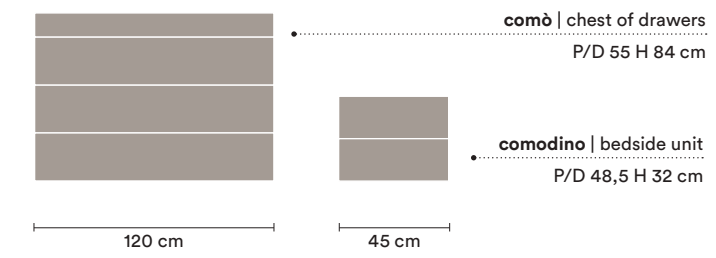

LIBRERIA INIFINITY | INFINITY BOOKSHELF

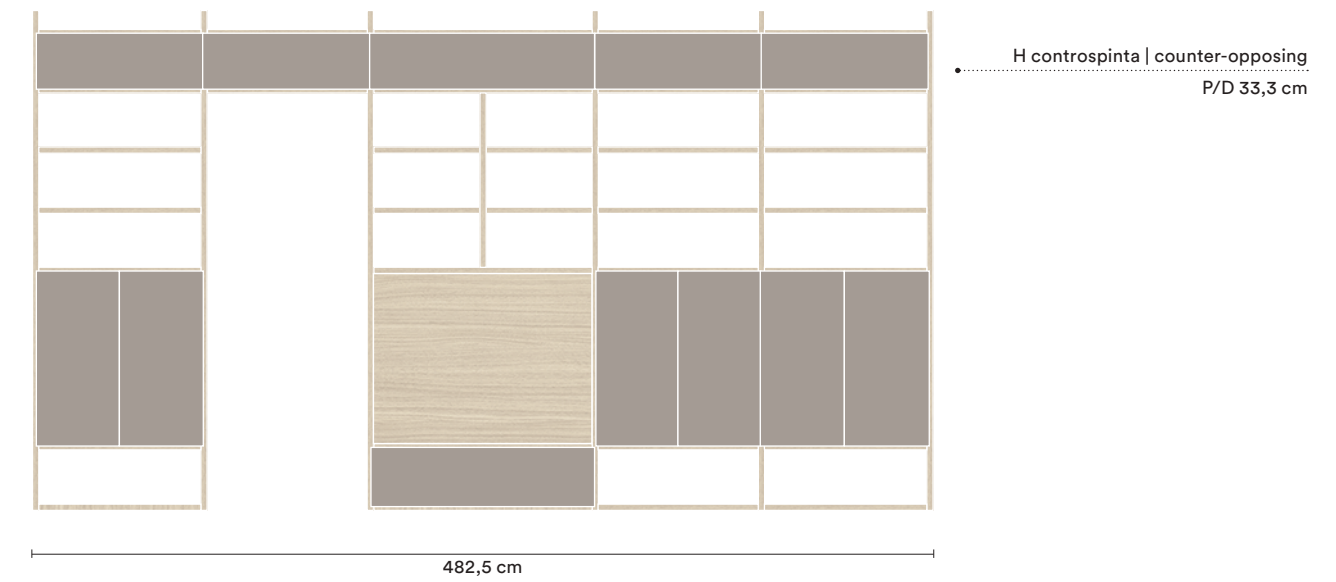

FINITURE | FINISHES

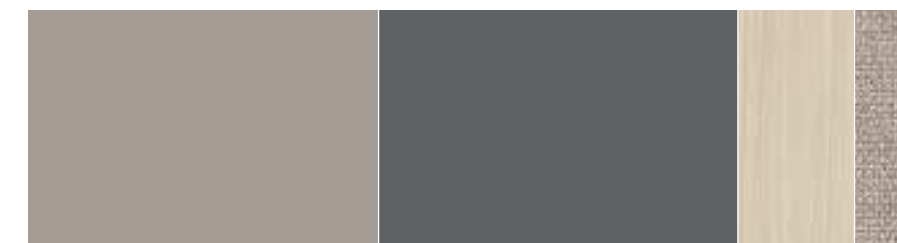

Basalto  
Grigio titanio  
Noce naturale  
Jenny Zinc

# N29



**IT**  
Armadio con anta scorrevole  
Cutting, letto Verso con piedini  
Delta, gruppo Brick con  
maniglia Bul.

**EN**  
Wardrobe with Cutting sliding  
door, Verso bed with Delta  
feet, Brick set with Bul handle.







**LETTO VERSO | VERSO BED**

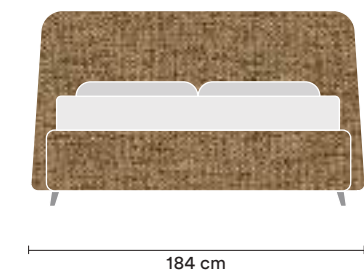

**GRUPPO BRICK | BRICK SET**

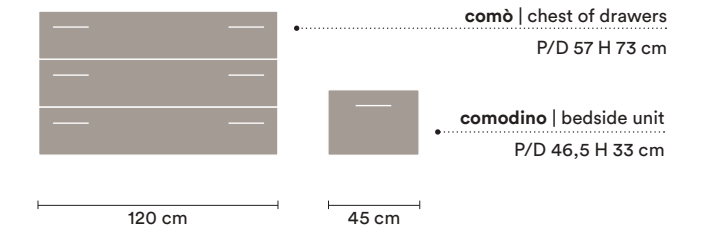

**ARMADIO ANTA SCORREVOLE CUTTING | WARDROBE WITH CUTTING SLIDING DOOR**

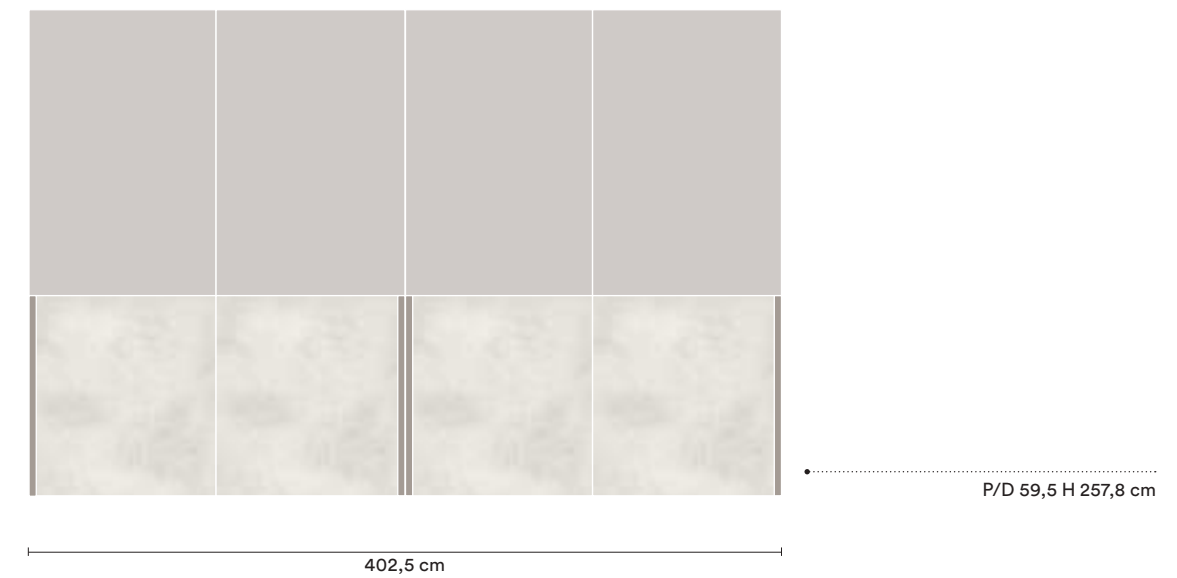

**FINITURE | FINISHES**

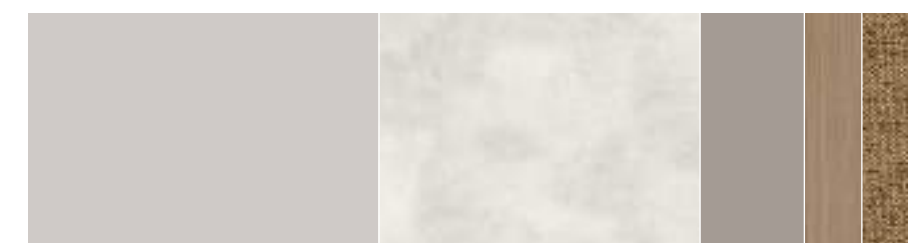

- Grigio
- Dorian
- Malta
- Basalto
- Noce
- Kenya
- Camel



# N30



**IT**  
Armadio con anta battente Cutting, ponte, letto Virgo con giroletto Atlante e gruppo Quadro.

**EN**  
Wardrobe with Cutting swing door, overhead, Virgo bed with Atlante bed frame and Quadro set.









LETTO VIRGO | VIRGO BED

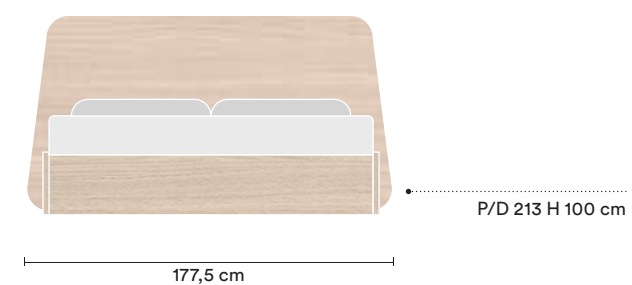

GRUPPO QUADRO | QUADRO SET

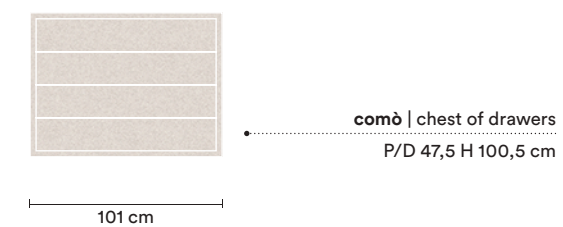

ARMADIO ANTA BATTENTE CUTTING | WARDROBE WITH CUTTING SWING DOOR

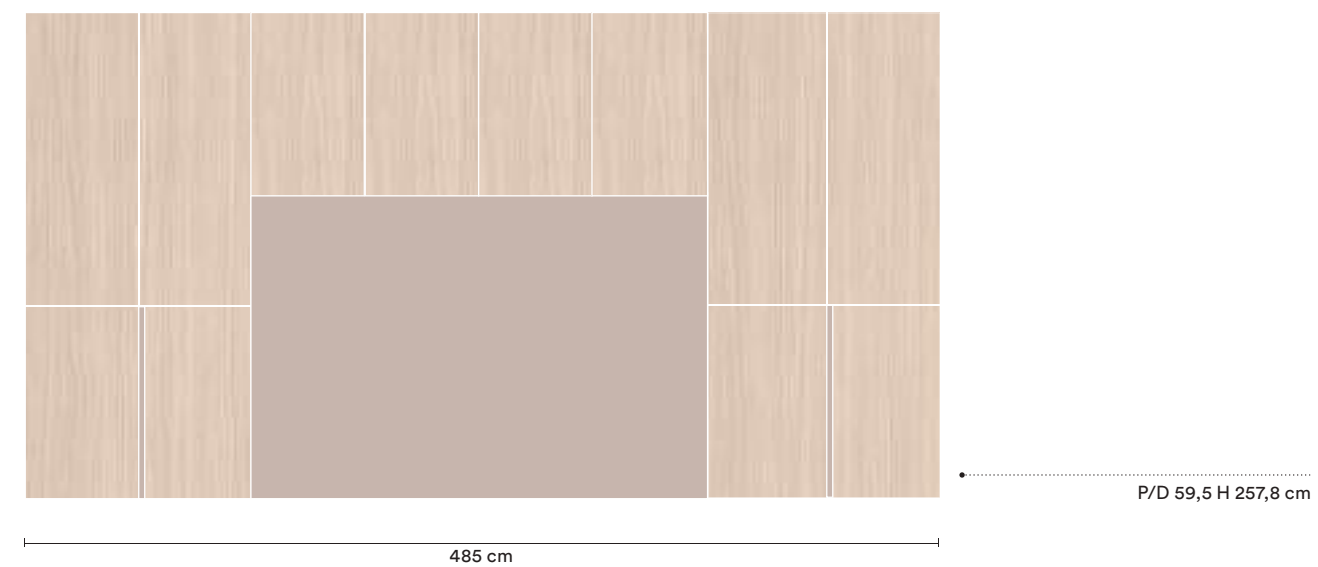

FINITURE | FINISHES



# N31

**IT**  
 Armadio con anta battente Club  
 e terminale Quid, letto Narciso  
 con piedini Delta, gruppo Look  
 su piedini Epsilon e libreria Up&Up.

**EN**  
 Wardrobe with Club swing door  
 and Quid end element, Narciso bed  
 with Delta feet, Look set on Epsilon  
 feet and Up&Up bookshelf.











**LETTO NARCISO | NARCISO BED**

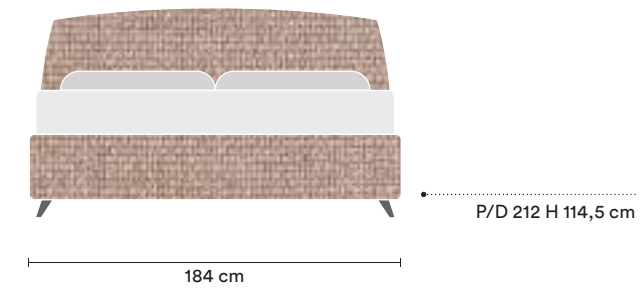

**GRUPPO LOOK | LOOK SET**

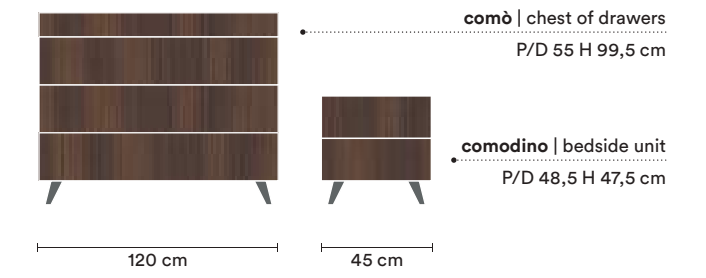

**ARMADIO ANTA BATTENTE CLUB  
| WARDROBE WITH CLUB SWING DOOR**



**LIBRERIA UP&UP  
| UP&UP BOOKSHELF**

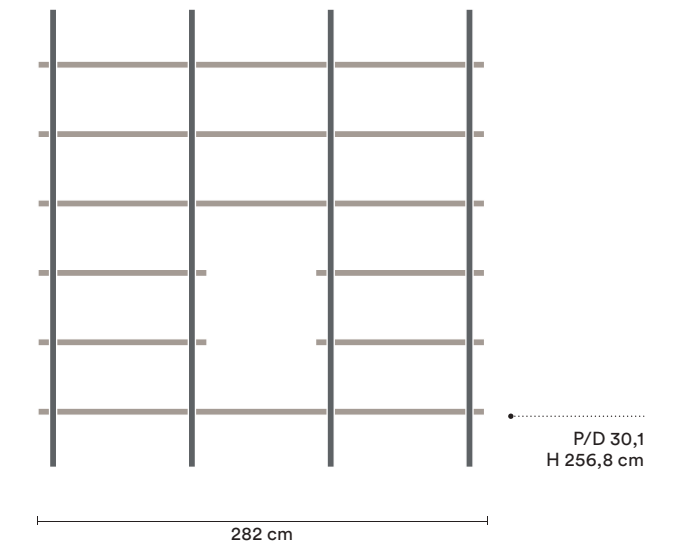

**FINITURE | FINISHES**

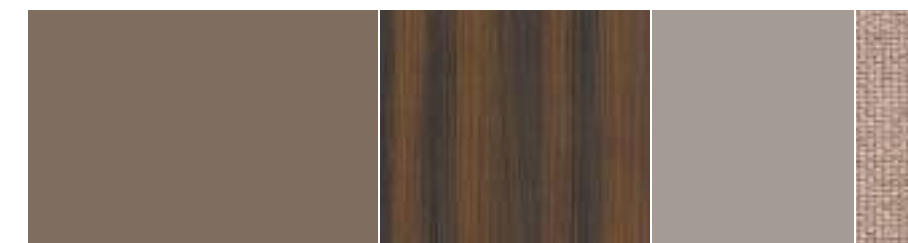

**Moka**  
**Eucalipto**  
**Basalto**  
**Jenny Papyrus**



# N32

**IT**  
 Armadio con anta battente Club,  
 guardaroba Flexo ad angolo, letto Cosy  
 con giroletto Sigma e piedini Twig,  
 gruppo Brick su piedini Twig,  
 pomello Pin e servomuto Bernardo.

**EN**  
 Wardrobe with Club swing door,  
Flexo corner walk-in, Cosy bed  
 with Sigma bed frame and Twig feet,  
 Brick set on Twig feet, Pin knob  
 and Bernardo valet stand.











**LETTO COSY | COSY BED**

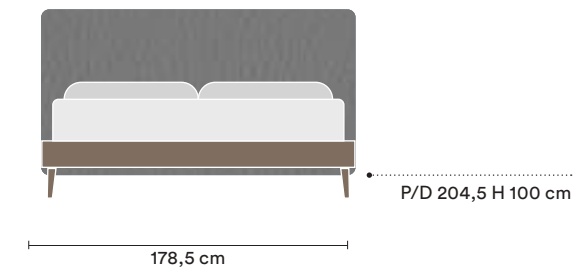

**GRUPPO BRICK | BRICK SET**

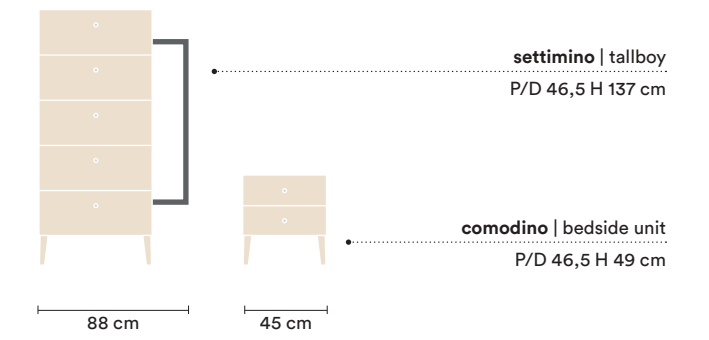

**ARMADIO ANTA BATTENTE CLUB E GUARDAROBA FLEXP  
| WARDROBE WITH CLUB SWING DOOR AND FLEXP WALK-IN**

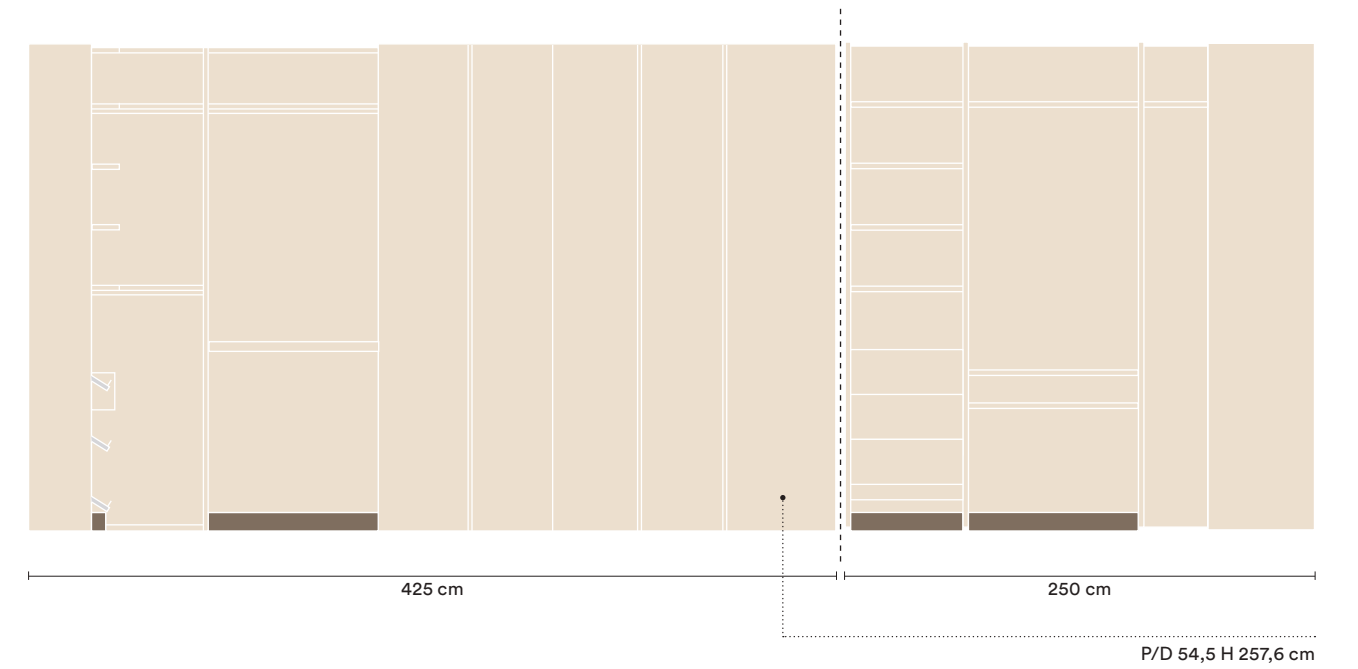

**FINITURE | FINISHES**



**Desert  
Moka  
Tape Fumo**

# N33

**IT**  
Guardaroba Flexo, letto Verso  
con piedini Delta e gruppo  
Gape su piedini Epsilon.

**EN**  
Flexo walk-in, Verso bed  
with Delta feet and Gape set  
on Epsilon feet.









LETTO VERSO | VERSO BED

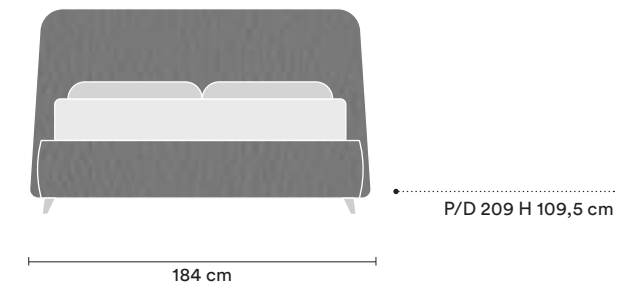

GRUPPO GAPE | GAPE SET

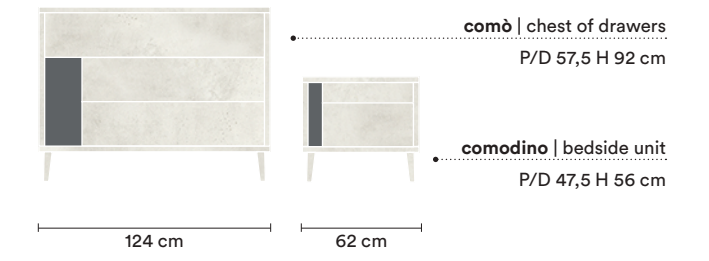

GUARDAROBA FLEXP | FLEXP WALK-IN

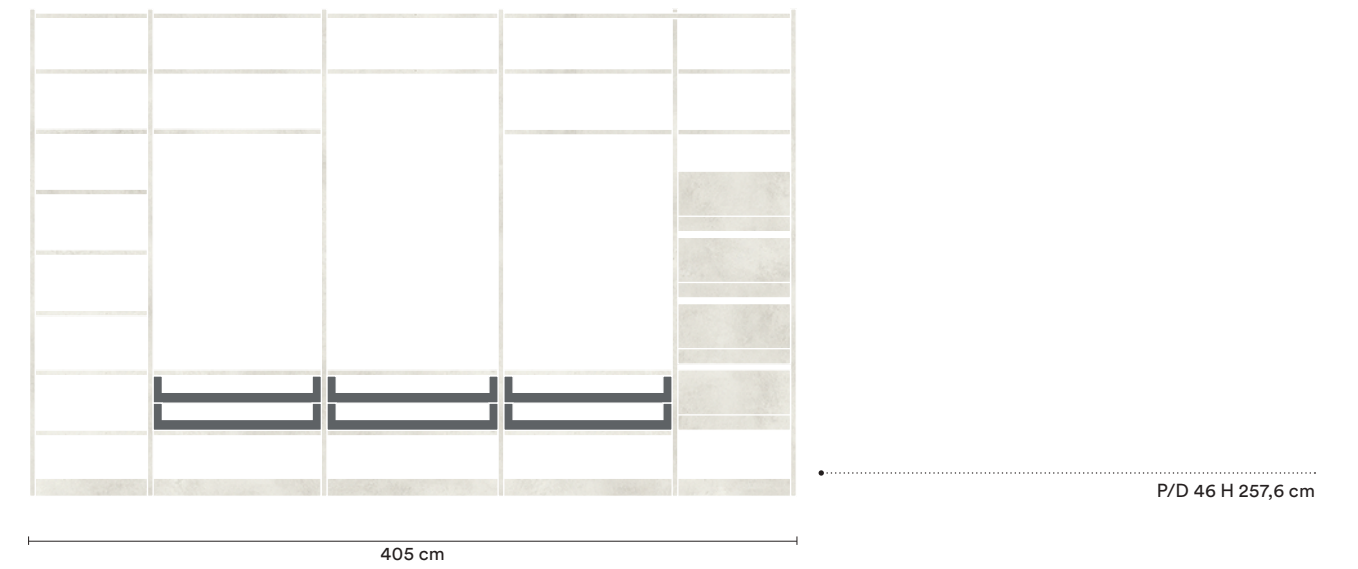

FINITURE | FINISHES



Malta  
Grigio titanio  
Tape Fumo



# N34

**IT**  
 Armadio con anta scorrevole  
Inserto, letto Cosy con giroletto  
Sigma e piedini Twig, gruppo  
Bold su piedini Nume e pensile Jib.

**EN**  
 Wardrobe with Inserto sliding door,  
Cosy bed with Sigma bed frame  
 and Twig feet, Bold set on Nume  
 feet and Jib wall unit.





**LETTO COSY | COSY BED**

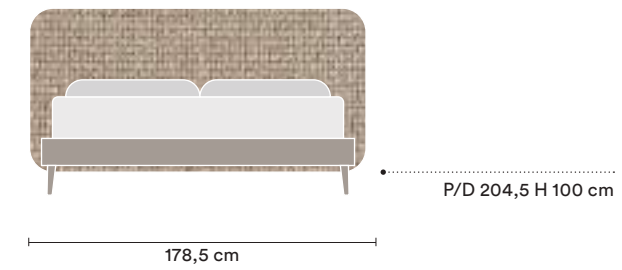

**GRUPPO BOLD | BOLD SET**

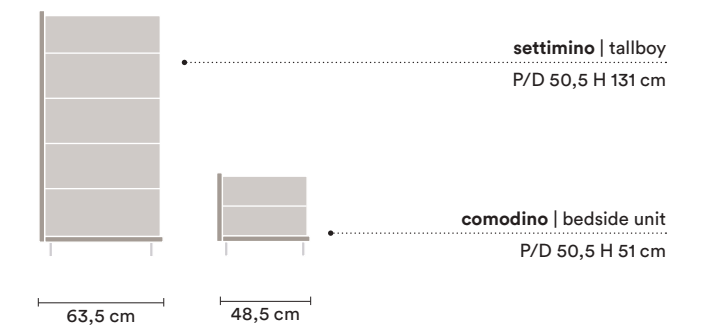

**ARMADIO ANTA SCORREVOLE INSERTO  
| WARDROBE WITH INSERTO SLIDING DOOR**

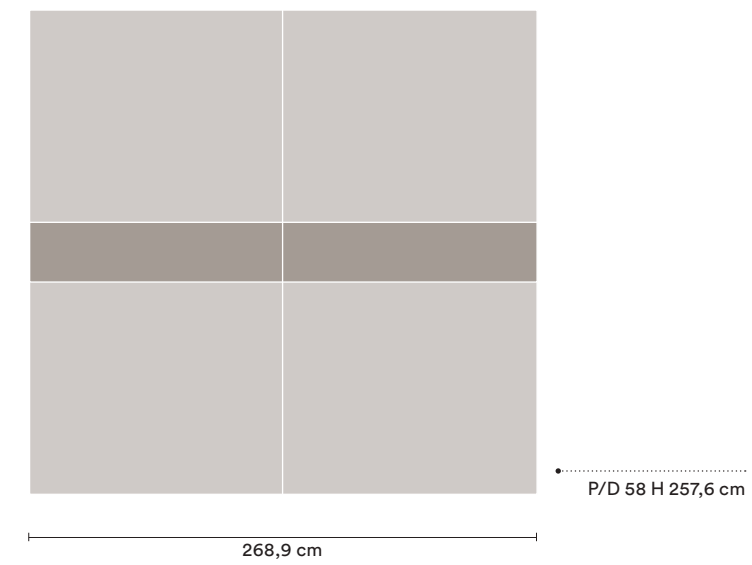

**PENSILE JIB | JIB WALL UNIT**

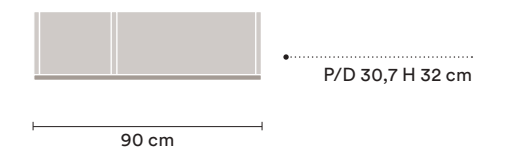

**FINITURE | FINISHES**

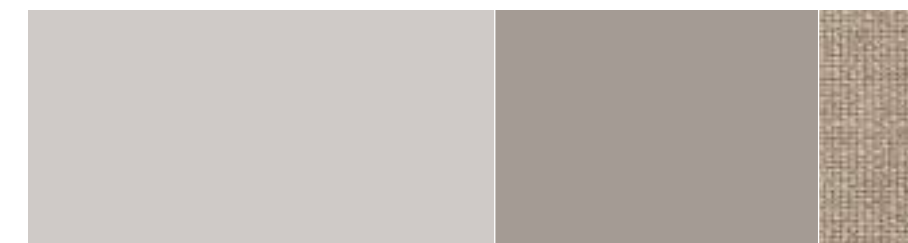

**Grigio Dorian  
Basalto  
Jenny Papyrus**



# Complementi

## Accessories

# Alba

Letto con alzatina | Bed with console table



**Alzatina da appoggio a parete**  
| Wall console table

L/W 200 P/D 26 H 78 cm



**Giroletto e testiera imbottiti**  
| Upholstered bed frame and headboard



**Panca fondo letto con cuscino**  
| End-of-bed bench with cushion

L/W 120 P/D 38 H 42,7 cm

**Giroletto e testiera retrofiniti  
per utilizzo centro stanza**  
| Rear-finished bed frame and  
headboard for use in centre of room





LETTI IMBOTTITI | PADDED BEDS

---

Snug



Time



Unique



Line



LETTI IMBOTTITI | PADDED BEDS

---

Narciso



Reverso



Verso



Slim



LETTI IMBOTTITI | PADDED BEDS

---

Adagio



Galaxy



Gallery



Twin



LETTI IMBOTTITI | PADDED BEDS

---

Kiss



Pad



Tetris



Kant





# Darsena

Sistema boiserie con giroletto | Panelling system with bed frame

## ELEMENTI PER LA CONFIGURAZIONE | ELEMENTS FOR CONFIGURATION

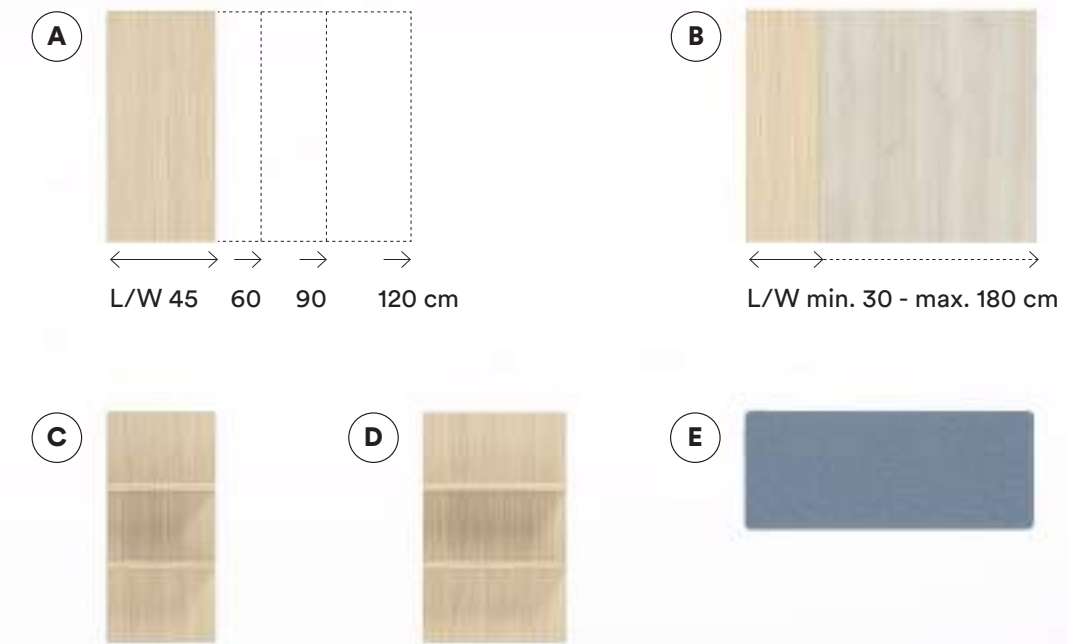

- A Pannello**  
| Panel  
P/D 2,6 H 96 cm
- B Pannello su misura**  
| Custom made panel  
P/D 2,6 H 96 cm
- C Pannello con mensole**  
| Panel with shelves  
L/W 45 P/D 28,6 H 96 cm
- D Pannello con mensole**  
| Panel with shelves  
L/W 60 P/D 28,6 H 96 cm
- E Cuscino per testiera**  
| Cushion for headboard  
L/W 120 cm

## ESEMPI DI COMPOSIZIONI | EXAMPLE COMPOSITIONS

**Variante 1** | 1 Variant  
L/W 360 P/D 7,6 H 192 cm



**Variante 2** | 2 Variant  
L/W 360 P/D 28,6 H 192 cm



**Variante 3** | 3 Variant  
L/W 330 P/D 28,6 H 96 cm



LETTI IN PANNELLO | PANEL BEDS

Cosy



Con giroletto Atlante  
| With Atlante bed frame

Cosy sospeso

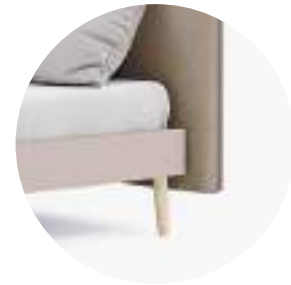

Con giroletto Sigma  
| With Sigma bed frame

Sector



Con giroletto Atlante  
| With Atlante bed frame



Con giroletto Marte  
| With Marte bed frame

Nadir



Con giroletto Atlante  
| With Atlante bed frame



Con giroletto Giove  
| With Giove bed frame

LETTI IN PANNELLO | PANEL BEDS

Leo



Con giroletto Atlante  
| With Atlante bed frame



Con giroletto Marte  
| With Marte bed frame

Virgo



Con giroletto Atlante  
| With Atlante bed frame



Con giroletto Marte  
| With Marte bed frame

Cushy



Con giroletto Atlante  
| With Atlante bed frame



Alloggiamento posteriore  
| Rear compartment



LETTI IN PANNELLO | PANEL BEDS

Musa



Con giroletto Giove  
| With Giove bed frame



Con giroletto Marte  
| With Marte bed frame

Diva



Con giroletto Giove  
| With Giove bed frame



Con giroletto Marte  
| With Marte bed frame

Mushy



Con giroletto Atlante  
| With Atlante bed frame



Alloggiamento posteriore  
| Rear compartment

LETTI IN PANNELLO | PANEL BEDS

Elfo



Con giroletto Atlante  
| With Atlante bed frame

Tais



Con giroletto Giove  
| With Giove bed frame

Normale



Con giroletto Atlante  
| With Atlante bed frame

# Laguna

Gruppo matrimoniale | Master bedroom set

## COME CONFIGURARE ELEMENTI DEL GRUPPO | HOW TO CONFIGURE ELEMENTS OF THE SET

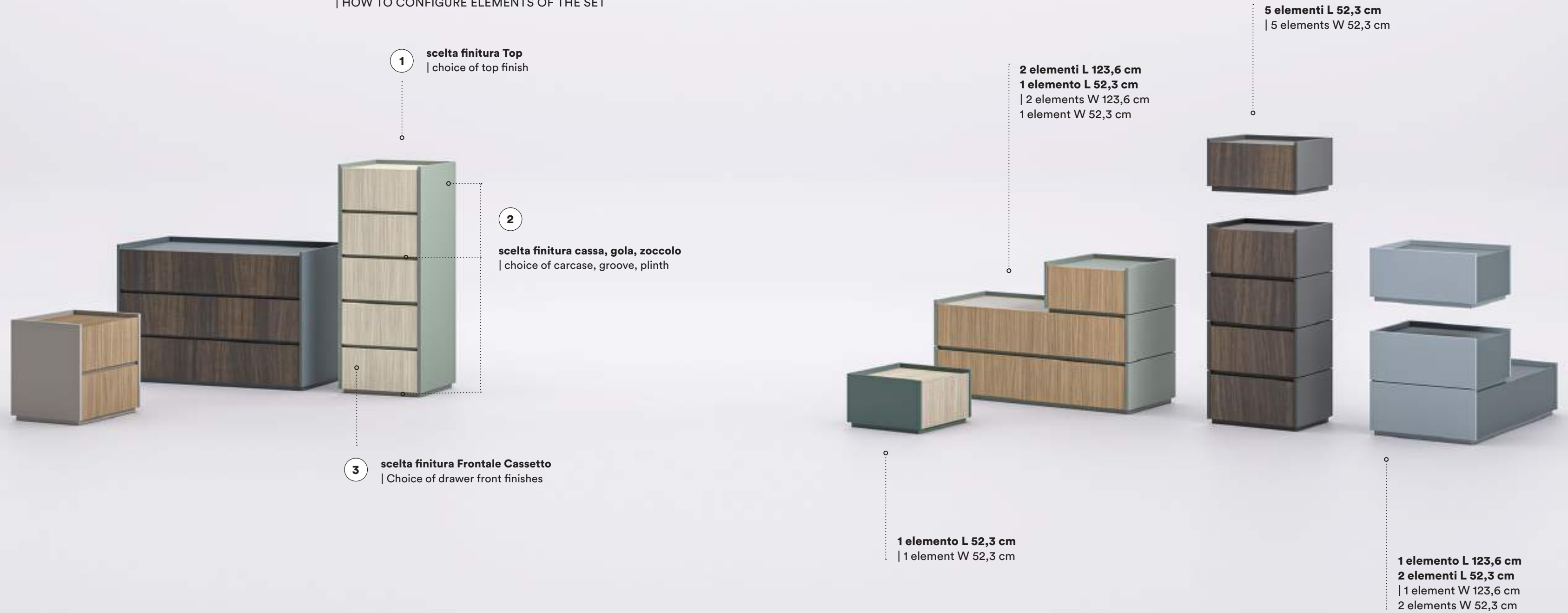



GRUPPI | BEDROOM SETS

---

Quadro



Look



Leader



GRUPPI | BEDROOM SETS

---

Label



Chic



Bold



GRUPPI | BEDROOM SETS

Brick



Stick



Tetris



GRUPPI | BEDROOM SETS

Tower



Gape



Tulip





# Finiture

## Finishes

**COLORI | COLOURS**

---



Bianco opaco



Bianco UV

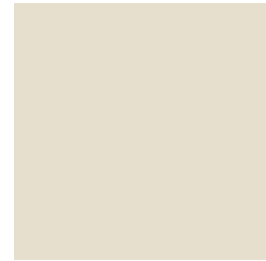

Desert



Canapa



Basalto



Moka



Grigio titanio



Grigio Dorian



Agave



Verde Alpi

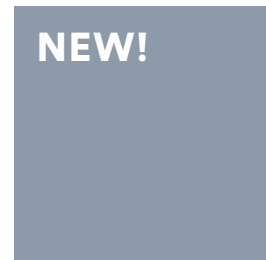

Cadaques



Blu opale

**LEGNI | WOODS**

---



Rovere white



Rovere Dorian



Ciliegio bianco



Noce naturale

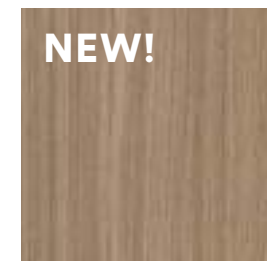

Noce

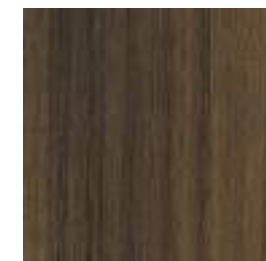

Eucalipto

**MATERICI | TEXTURES**

---



Cemento Masdar



Feltro



Leather grey



Malta



TESSUTI | TEXTILES

TESSUTO JENNY



Papyrus

Pill

Coriander

Nox

Bombay



Strawberry

Carioca

Zinc

Grey

Greystone



Smoke

Steel

Water green

SIMILPELLE TAPE



Ottico

Seta

Tenda

Testa di moro

Mais

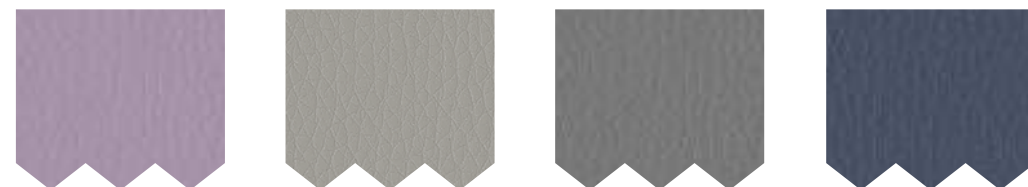

Violetto

Creta

Fumo

Oceano

TESSUTI | TEXTILES

TESSUTO ECOCHIC



Dorian

Desert

Domy

Zafferano

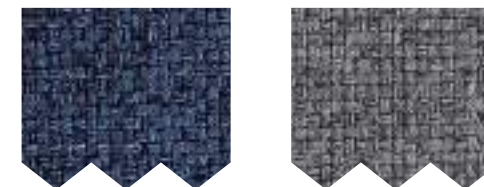

Opale

Titanio

SIMILPELLE ECOCHIC

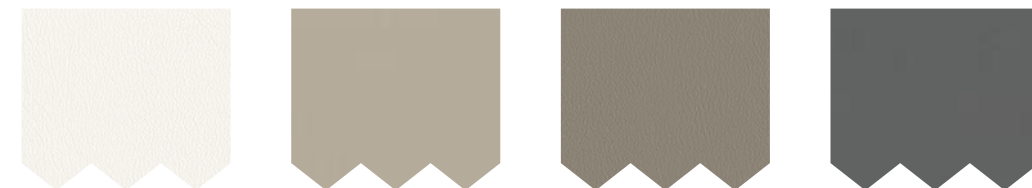

Bianco candido

Travertino

Limo

Elephant



Fiordaliso

Malva

Senape

TESSUTO KENYA

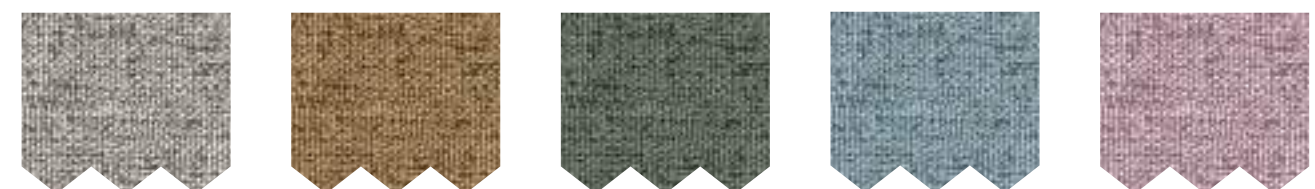

Taupe

Camel

Forest

Turquoise

Pink



# L'habitat contemporaneo giovane e dinamico

The young and dynamic contemporary habitat



N01

p.10



N02

p.22



N03

p.30



N04

p.38



N05

p.44



N06

p.52



N07

p.56



N08

p.62

# La residenza calda e materica

The warm and textured residence



N09

p.72



N10

p.80



N11

p.86



N12

p.92



N13

p.100



N14

p.106



N15

p.110



N16

p.114



N17

p.120



N18

p.126



N19

p.130

# L'appartamento d'epoca tra ieri e oggi

The period apartment of past and present



N20

p.138



N21

p.148



N22

p.156



N23

p.162



N24

p.170



N25

p.176



N26

p.182



N27

p.188

# Il loft essenziale e luminoso

The bright and essential loft



N28

p.198



N29

p.208



N30

p.214



N31

p.220



N32

p.226



N33

p.232



N34

p.238



# Rispetto dell'ambiente

## Respect for the environment



**Economia circolare**  
Produciamo strutture e ante in nobilitato costituite da pannelli ecologici provenienti da fornitori certificati FSC® che utilizzano legno pre e post-consumo a cui viene data una seconda vita in virtù di un'economia circolare che si autoalimenta, senza andare a intaccare il nostro patrimonio forestale.

**Circular economy**  
We produce melamine-faced structures and doors consisting of ecological panels produced by FSC® certified suppliers who use pre- and post-consumer wood, which is given a second life thanks to a self-perpetuating circular economy, without impacting our existing forests.



**Materiali eco-friendly**  
Utilizziamo vetro e alluminio, riciclabili all'infinito per realizzare prodotti resistenti e di grande impatto estetico, e PET per superfici sicure che non rilasciano alcuna emissione tossica durante il ciclo di produzione e utilizzo.

**Eco-friendly materials**  
We use glass and aluminium, infinitely recyclable materials to develop resistant products with a high visual impact, and PET for safe surfaces without toxic emissions either during production or use.



**Diagnosi energetica**  
Monitoriamo costantemente i consumi totali e definiamo azioni di miglioramento sistemico per ottimizzare il nostro impatto energetico.

**Energy diagnosis**  
We constantly monitor our total consumption and define systemic improvement actions to optimise our energy impact.



**Imballaggio**  
Impieghiamo solo cartoni realizzati con carta riciclata, riducendo progressivamente l'uso della plastica per sostituirla completamente con materiali green.

**Packaging**  
We use only boxes made of recycled paper, gradually reducing the use of plastic, to be completely replaced with eco-friendly materials.



**Durabilità dei prodotti**  
Progettiamo prodotti con una maggiore vita utile per ridurre i rifiuti e offrire alti standard qualitativi.

**Product durability**  
We design products that last longer to reduce waste and offer high quality standards.



**Attitudine green-living**  
Abbiamo azzerato l'utilizzo della plastica negli uffici e nella produzione installando distributori d'acqua e recuperiamo tutti i rifiuti che produciamo con la nostra attività industriale.

**Green-living attitude**  
We have eliminated the use of plastic in our offices and production department by installing water dispensers, and recover all the waste we produce through our industrial activities.



**Logistica interna**  
Abbiamo ottimizzato tutte le movimentazioni all'interno dell'azienda per ridurre al minimo lo spreco di risorse energetiche e la produzione di CO<sub>2</sub>.

**Internal logistics**  
We have optimised all internal company logistics to reduce energy wastage and CO<sub>2</sub> production to a minimum.



**Ottimizzazione degli spazi**  
Riduciamo lo spreco dei materiali da costruzione ottimizzando gli spazi con le nostre soluzioni di arredo che si adattano alle diverse architetture grazie alla loro ampia modularità e personalizzazione.

**Space optimisation**  
We reduce building material waste by optimising spaces with our own furniture solutions, perfectly adaptable to different architectures thanks to their extensive modularity and customisation.



**Innovazione**  
Siamo sempre alla ricerca di materiali e materie prime uniche che ci permettono di proporre sul mercato prodotti di alta qualità dal design distintivo. Abbiamo introdotto un sistema di intelligenza artificiale che pianifica la produzione, massimizza la produttività e facilita le operazioni di logistica e smistamento riducendo, in maniera significativa, gli sprechi.

**Innovation**  
We are always on the lookout for unique and raw materials allowing us to offer the market high-quality products with a signature design. We have introduced an artificial intelligence system that plans production, maximizes productivity and facilitates logistics and sorting operations by reducing waste significantly.



**Tecnologie green**  
Scegliamo materiali naturali al 100% resi straordinari da processi innovativi come la tecnologia di sinterizzazione che permette di creare pietre ceramiche senza l'utilizzo di colle e sostanze inquinanti. Abbiamo adottato l'utilizzo di vernici bio certificate Greenguard che garantiscono basse emissioni e una migliore qualità dell'aria negli ambienti domestici.

**Green technologies**  
We chose 100% natural materials with an excellent performance from innovative processes such as sintering technology which allows ceramic stone to be created without using adhesives or polluting substances. We have adopted the use of Greenguard certified organic paint that ensure low emissions and better air quality in home environments.



**Trasporto**  
Organizziamo le spedizioni ottimizzando gli spazi e i percorsi delle consegne per ridurre le emissioni di CO<sub>2</sub> sul pianeta.

**Transport**  
We organise shipments by optimising space and delivery routes to reduce CO<sub>2</sub> emissions on the planet.



**Progetti Speciali**  
Aderiamo al Furniture Pact, un progetto ideato dal Sustainability Lab di SDA Bocconi School of Management, che mira a supportare le aziende della filiera del legno-arredo verso l'adozione di modelli gestionali sempre più sostenibili.

**Transport**  
We are joining the Furniture Pact, a project conceived by the Sustainability Lab of SDA Bocconi School of Management, which aims to support companies in the wood-furniture supply chain toward the adoption of increasingly sustainable management models.



**UNI EN ISO 14001**  
Abbiamo certificato il nostro sistema di gestione ambientale in conformità agli standard alla norma UNI EN ISO 14001.

**UNI EN ISO 14001**  
We have certified our environmental management system in compliance with standard UNI EN ISO 14001.

La Colombini S.p.A. si riserva il diritto di apportare, senza alcun preavviso, le modifiche che riterrà più opportune al fine di migliorare il prodotto.

La Colombini S.p.A. reserves the right to make any changes, without advance notice, that feels needed in order to improve the product.

### **Credits**

concept, art direction and graphic design  
**dogtrot**

6-42; 72-104; 138-167; 198-218  
dogtrot

44-66; 106-134; 170-193; 220-240  
Studio Ferriani

color separation  
**Bieffe**

### **COLOMBINI S.p.A.**

Azienda certificata UNI EN ISO 9001  
Azienda certificata UNI EN ISO 14001

Strada Ca' Valentino, 124  
47891 Falciano  
Repubblica di San Marino

Telefono da Italia 0549 943573  
International calls +378 0549 975948

[www.colombinicasa.com](http://www.colombinicasa.com)  
[www.colombinigroup.com](http://www.colombinigroup.com)



# NIGHT &DAY

**COLOMBINI S.p.A.**

Azienda Certificata UNI EN ISO 9001  
Azienda Certificata UNI EN ISO 14001

Strada Ca' Valentino, 124  
47891 Falciano - Repubblica di San Marino

Telefono da Italia: 0549 943573  
International Calls +378 0549 975948

[www.colombinigroup.com](http://www.colombinigroup.com)  
[www.colombinicasa.com](http://www.colombinicasa.com)