

DOMINO

Cucine moderne / Modern kitchens

PRIMA
CUCINE

Nelle prossime pagine è probabile che incontrerai la tua cucina o elementi che la andranno a comporre. È una scelta importante che ti porterà a immaginare nuove prospettive e concretizzare sogni finora sussurrati.

Serve esperienza. Noi l'abbiamo, da tempo. Prima Cucine nasce da imprenditori del settore per dare risposta a chi cerca una soluzione d'avvio, ovvero "accessibile", e moderna, bella e affidabile, ovvero "di qualità". E magari Made in Italy? Certo, lasciaci fare.

As you browse the following pages, you will probably come across your future kitchen, or parts of it. You've got important decisions to make. New horizons will open up as previously impalpable dreams begin to materialise before your eyes.

Experience is vital. And we've got plenty of it. Prima Cucine was founded by entrepreneurs from the sector who wanted to meet the needs of those looking for a first kitchen, an affordable one, but also one that was modern, appealing and reliable. In other words, a quality kitchen. And possibly a fine Italian one? What else! Leave everything up to us.

DOMINO È MODERNA E ACCESSIBILE.

Osserva le composizioni, segna cosa vorresti e ricorda:
le scocche dei mobili e i singoli elementi sono trasversali
a tutte le nostre proposte.

Le possibilità di combinazioni sono infinite.
La tua Prima Cucine è all'orizzonte.

DOMINO IS MODERN AND AFFORDABLE.

Browse through the compositions, take note of what you would like and remember:
the cabinet carcasses and individual elements can be used with all our solutions.
Countless combinations are available.
Your Prima Cucine kitchen is awaits.

INDICE COMPOSIZIONI | INDEX COMPOSITIONS



p. 06 | 13



p. 14 | 21



p. 22 | 29



p. 30 | 37



p. 38 | 45



p. 46 | 55



p. 56 | 65



p. 66 | 75



p. 76 | 85

DOMINO

Cucine moderne / Modern kitchens

Sei nel mondo Domino, il primo modello creato da Prima Cucine. Ha l'anta liscia o a telaio lineare per un'estetica moderna, facile da comporre, e un mood duraturo.

Scegli fra vari materiali e finiture: melaminico, il più conveniente, laccato UV, il più stiloso, laccato UV opaco ("super matt"), anti-impronta e ben resistente, laccato opaco, il più raffinato, o PET, il più pratico.

Welcome to the world of Domino, the very first model created by Prima Cucine. Easy to put together, it features either slab doors or ones with a linear frame for a modern aesthetic and timeless vibe.

Choose from the various materials and finishes available: melamine is the most reasonably priced, UV lacquered is the most stylish, matt UV lacquered ("super matt") is fingerprint-resistant and hardwearing, matt lacquered is the most refined and PET is the most practical.



DOMINO 01

Uno spazio ampio da arredare con una cucina duratura e accessibile. Scegli una soluzione a isola come Domino 01, realizzata con materiali pratici e resistenti, proposti in finiture dalla notevole resa estetica, amplificata dall'accostamento inusuale di volumi semplici.

Le basi sono in PET sale, una materia plastica PVC free dalla mano liscia, le colonne e i pensili sono in melaminico resina grey, materico al tatto, e i top e lo schienale in laminato elite, con il tocco della venatura che simula il marmo. Un effetto di calore, condiviso con il piano snack, in olmo cenere. I volumi sfalsati della parte in linea sono mantenuti uniti con leggerezza dagli schienali Unit.

A large space to be furnished with a long-lasting affordable kitchen. Opt for an island style. Like Domino 01 made from practical sturdy materials with extremely attractive finishes and an aesthetic that is further enhanced by unusual juxtapositioning and simple lines.

The base units come in PET (a PVC-free plastic with a smooth texture) with a sale finish whereas the tall and wall units are in resina grey melamine with a touchable surface and the back panel in elite laminate boasts marble-effect veining. The overall effect is one of cosiness, further enhanced by the snack counter in olmo cenere. The staggered placement of the units against the wall is tied together by the airy Unit back panels.



Basi / base units: sale
Colonne e pensili / tall and wall units: resina grey
Top e schienale / countertops and back panel: elite
Elementi a giorno / open elements: brunito Unit
Piano snack / snack counter: olmo cenere
Gola e zoccolo / grip profile and plinth: brunito



DOMINO 01

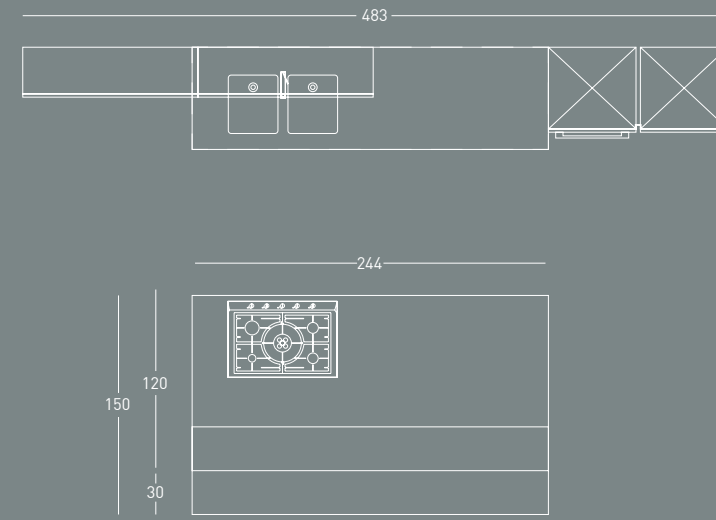

Gli schienali Unit di Prima Cucine sono elementi modulari di diverse dimensioni, accessoriabili in svariati modi. Qui sono abbinati allo schienale con la stessa finitura dei top, striata da una vena calda, raffinato effetto di tendenza che dà carattere ai toni neutri.

Prima Cucine's Unit back panels are modular elements in a variety of shapes and sizes with a host of different options in terms of accessories. Here, they are shown with a back panel in the same finish as the work top and feature an intricate vein pattern that provides a refined on-trend touch and lifts the neutral palette.





DOMINO 02

Hai un ampio open space con salotto integrato? Rendilo un ambiente di design con linee moderne e minimaliste e qualche piccolo accorgimento: le colonne poste in nicchia, un punto colore originale, un'isola con piano snack ad altezza tavolo, in appoggio su un supporto in vetro trasparente, e pratiche mensole ricavate da una libreria trasformista come Graphic.

La finitura oltremare scelta per le basi e i pensili colpisce non solo perché è un tono ricercato di blu, ma anche perché ha la raffinata resa estetica del laccato opaco. Per completare l'arredo sono sufficienti due semplici sedie Sammy con struttura piombo e seduta antracite.

Do you have an open-plan layout that is at one with the living area? Turn your area into a sophisticated setting with a modern minimalist aesthetic and curated detailing: inset tall units, an original pop of colour, an island with a table-height snack counter that rests on a support in transparent glass and practical shelves borrowed from a versatile bookcase like Graphic.

The oltremare finish on the base and wall units doesn't only catch the eye due to its jewel-bright tone, but also because of the sheer refinement of the matt lacquered surface. The whole composition has been rounded off with two unfussy Sammy chairs with a piombo structure and antracite seat.



Basi e pensili / base and wall units: oltremare
 Colonne e piano snack / tall units and snack counter: rovere stone
 Top e schienali / countertops and back panels: granit grey
 Elementi a giorno / open elements: Graphic piombo and rovere stone
 Gola e zoccolo / grip profile and plinth: piombo



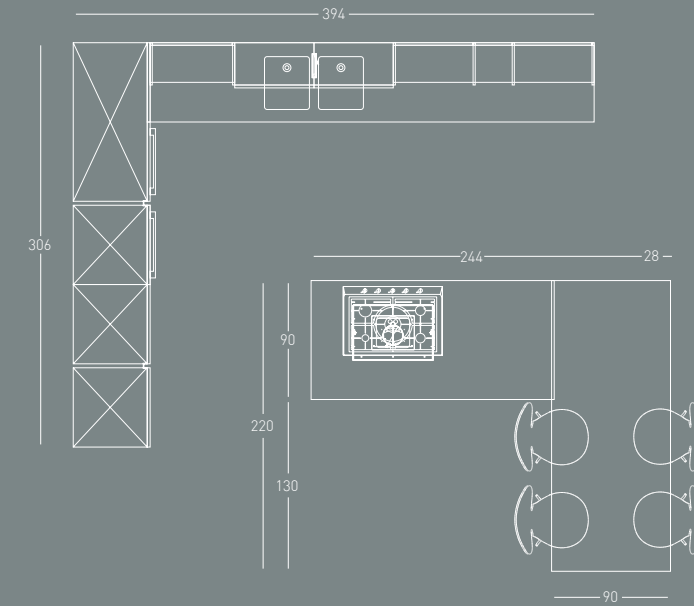

Ai lati dei pensili ci sono la libreria Graphic con struttura piombo, i ripiani in rovere stone e lo schienale in laminato granit grey. Quest'ultimo è un materiale molto resistente, lo stesso usato per i piani di lavoro e l'alzatina dietro l'area lavaggio.

The wall units are flanked on either side by the Graphic bookcase with a piombo structure, shelves in rovere stone and a back panel in granit grey laminate. The latter is an extremely hardwearing material that is also used for the worktops and the upstand behind the washing area.





DOMINO 03

Per mantenere continuità fra salotto e cucina in due ambienti non del tutto separati, un valido elemento è la colonna libreria con vani a giorno da porre di fianco rispetto alle colonne, disponibile sia per il lato sinistro che destro.

Entri così in una composizione lineare semplice che adotta accorgimenti per acquisire movimento. Dapprima il colore Marsala delle basi in PET, ripreso da quello rosso Jaipur del top in Fenix®, che spicca sul caldo rovere anice e sul neutro resina light; quindi il top a profondità maggiorata che fa avanzare le basi rispetto alle colonne e pare far indietreggiare i pensili; infine il cambio di registro dei vani a giorno. Pochi stratagemmi, per una cucina di carattere.

A sense of cohesiveness between the living room and kitchen located in two not entirely-separate settings has been obtained by the tall bookcase unit with open shelving (available for both the left and right side) on the side of the columns.

This creates a simple one-wall composition that has been visually enlivened by a series of thoughtful details. The first of these details is the Marsala hue on the PET base units picked up again by the rosso Jaipur of the Fenix® worktop which pops against the warm rovere anice and the neutral resina light; then, there is a deeper worktop which causes the base units to protrude past the tall units and gives the impression that the wall units are further in the background; last but not least, the open compartments add visual interest. A few simple tricks for a kitchen with a powerful personality.



Basi ed elemento a giorno / base units and open element: Marsala
Colonne ed elementi a giorno / tall units and open elements: rovere anice
Pensili / wall units: resina light
Top / countertop: Fenix® rosso Jaipur
Maniglia e zoccolo / handle and plinth: piombo



DOMINO 03

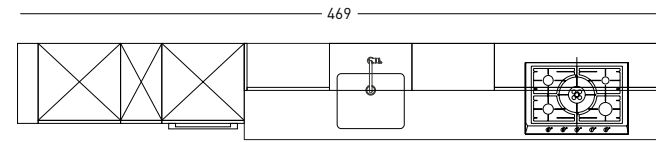

La maniglia 1550 in finitura piombo è perfetta per una presa sicura e per aprire le ante in libertà senza rischiare graffi fra due vicine, grazie alla soluzione a incasso. La barra sottopensile Eos, nello stesso tono colore, è ideale per chi predilige la linearità, ha la luce a LED integrata e può essere completata da svariati accessori.

The 1550 handle in a piombo finish provides a perfect secure grip and the recessed design means that the doors can be opened freely without worrying about two adjacent doors scratching each other. The Eos undercabinet rail rack in a matching hue is an ideal addition for anyone who likes a pristine linear look: featuring an integrated LED light, it can also be completed with various accessories.

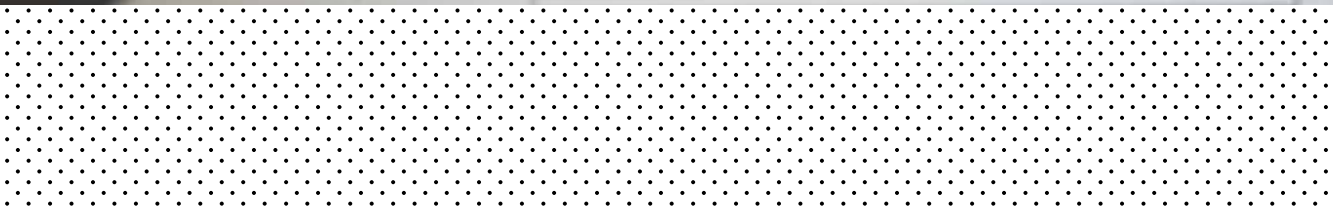
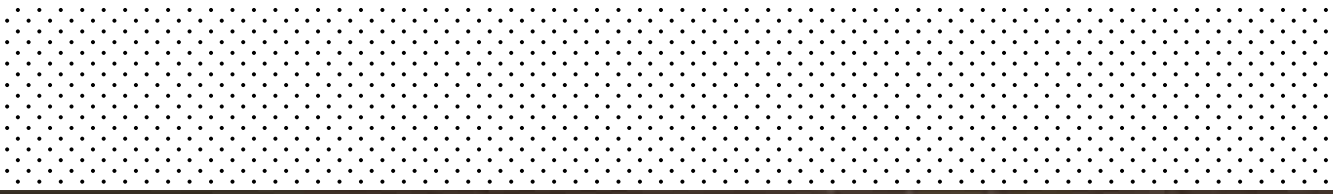

DOMINO 04

Sei di fronte a una scelta estetica sicura: la pulizia del bianco, riscaldata dal legno, evidenziata dal contrasto con la finitura piombo di sgabelli, zoccoli dei mobili e gole d'apertura.

Ha poi aspetti pratici, primo fra tutti il laccato UV super matt di basi e colonne. Visto che i prodotti per la laccatura sono induriti da lampade a raggi ultravioletti (UV), le superfici diventano facili da pulire e resistenti a graffi e usura.

Pratica è anche la libreria Stilo a parete perché dà molte mensole da usare per la cucina e avvicina come stile al salotto che spesso, lo sappiamo, è proprio lì. Ha inoltre incorporate luci effetto "wall wash", una sorta di cascata luminosa sul muro. Bella atmosfera.

This is a safe aesthetic choice: elegant white with the warm appeal of wood, highlighted by a contrast with the lead finish of the stools, the plinths of base units and grip profile openings. It also offers practical aspects, first and foremost the super matt UV lacquer of base and tall units. Since lacquered products are hardened by ultraviolet (UV) lamps, their surfaces become easy to clean and resistant to scratches and wear.

The wall-mounted Stilo bookcase is also practical, as it offers many shelves for use in the kitchen. It's similar in style to the living room, which we know is often right next to it. In addition, it has an incorporated "wall wash" effect, a kind of luminous waterfall on the wall. A beautiful atmosphere.



Colonne e basi / tall and base units: bianco polare
Pensili / wall units: rovere dark
Top / countertop: resina lava
Piano snack / snack top: rovere dark
Gola e zoccolo / grip profile and plinth: piombo



DOMINO 04

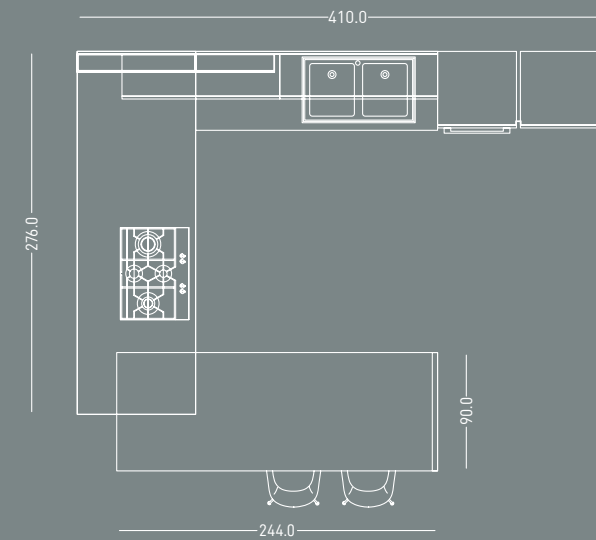

Misure da considerare. Non c'è mai abbastanza posto per riporre. Sfrutta allora il piano di lavoro con i vani Unit d'alluminio in appoggio, fissati a parete. Qual è invece lo spazio del frigorifero? È standard, ma se ti piace grande, stile americano, come in questa Domino 04, la larghezza è 75 cm.

Dimensions to take into consideration. There is never enough space to put things. So, make the most of the countertop with wall-mounted Unit compartments in aluminium. How much space is there for the refrigerator? It's a standard size but if you want a large one, American-style, as in this Domino 04 kitchen, it's 75 cm wide.



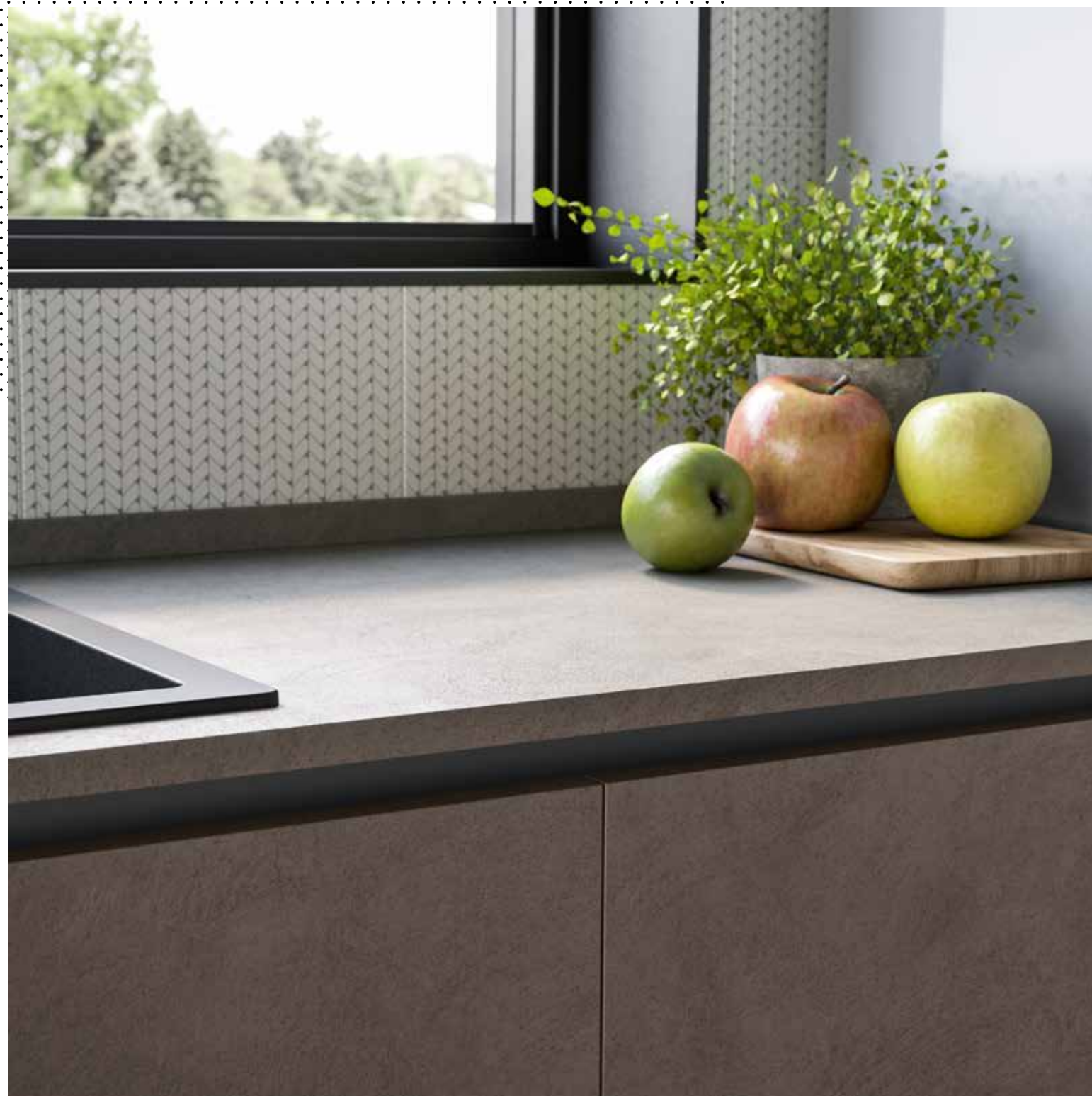

DOMINO 05

Domino 05 è una cucina robusta, pratica e attenta allo stile. Robusta grazie alle ante di basi, top ed elemento a giorno in melaminico, scelta che punta anche alla convenienza; robusta grazie alle ante di colonne e pensili in laccato UV lucido, effetto simile al vetro.

La praticità e lo stile dei mobili Prima Cucine si allargano pure alla scelta degli elettrodomestici, che influenzano molto la vita quotidiana. La cappa in vetro nero, semplice e intuitiva da installare, permette l'uscita fumi dell'aspirazione direttamente nel muro posteriore. Elimina così l'utilizzo di camini e preserva l'estetica originale. Il forno a tre manopole è dotato anche di porta click&clean per una pulizia accurata e veloce.

Domino 05 is a sturdy, practical and style-conscious kitchen. It's sturdy thanks to the base unit doors, the countertop and open element in melamine, a choice also based on affordability, and to the tall unit doors in glossy UV lacquer, with a glass-like effect.

The practicality and style of Prima Cucine furniture also extends to the choice of appliances, which greatly affect daily life. The black glass hood, with easy and intuitive installation, provides an outlet for fume suction directly on the rear wall. It eliminates the use of a chimney and preserves the original aesthetic look. The three-knob oven is also fitted with a click&clean door for quick and thorough cleaning.



Basi e top / base units and countertop: resina bronzo
 Pensili e colonne / wall and tall units: grigio gloss
 Elementi a giorno / open elements: rovere vintage
 Gola e zoccolo / grip profile and plinth: piombo



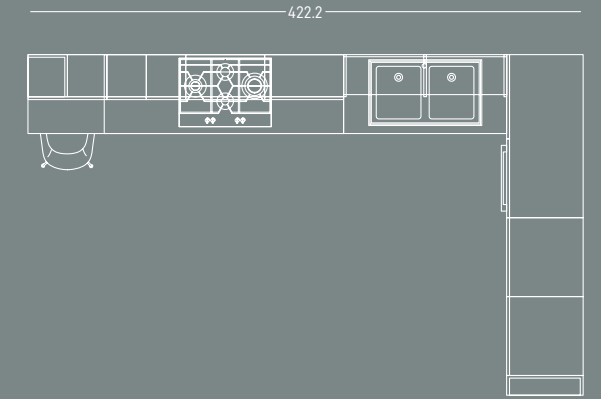

Per rendere funzionale il piano di lavoro, oltre alla barra portautensili cromata, abbiamo inserito due capienti cestoni, uno attrezzato per avere le pentole a portata di mano, l'altro con cassetto interno e portaposate per una presa comoda. Ad altezza pensile, infine, abbiamo posizionato un vano a giorno.

To make the countertop functional, in addition to the chrome-plated utensil bar, we have included two spacious deep drawers, one equipped to have pots and pans to hand, and the other with an internal drawer and cutlery tray for easy access. Then we have positioned an open compartment at wall-unit height.





DOMINO 06

Hai un open space con salotto integrato in una superficie ridotta? Ben organizzata, ti dà tutto ciò che serve. In Domino 06, la cucina in linea a parete sfrutta colonne dispensa separate, a larghezza maggiorata da 75 cm, anziché standard da 60 cm. Sono in melaminico poro aperto opaco rovere scott e hanno la maniglia verticale 1540, abbinata alle maniglie orizzontali delle basi in melaminico grigio matt.

Se usi gli stessi materiali nell'angolo salotto dai continuità e fai sembrare più grande e armonioso l'ambiente. E per aggiungere personalità all'insieme, bastano finiture a contrasto e la disposizione sfalsata per il pannello che fa da sfondo e il mobile basso con apertura push-pull.

Do you have an open space kitchen integrated with the living room in a small area? If well-organised, it can provide all you need. With Domino 06, an in-line wall-mounted kitchen allows maximum use of individual storage units, with an increased width of 75 cm instead of the standard 60 cm. They are available in matte rovere scott open pore melamine with a 1540 vertical handle, combined with the horizontal handles of base units in grigio matt melamine.

If you use the same materials in the living room area, you can provide continuity and make the room look larger and more harmonious. And to add personality to the overall effect, all you need is contrasting finishes and an offset layout for the panel, which acts as a background, and a low cabinet with a push-pull opening.





Basi / base units: grigio matt
Pensili e colonne / wall and tall units: rovere scott
Top / countertop: quarzo opale
Elementi a giorno / open elements: Graphic piombo e rovere scott
Maniglia e zoccolo / handle grip and plinth: piombo



Il piano di lavoro in quarzo opale è molto resistente a macchie, prodotti per la pulizia e impatti, e richiede poca manutenzione. Dura una vita ed è pure bello. Subito sopra, ci sono i pensili e fra loro la libreria Graphic. È utilizzata per creare i vani a giorno.

The quarzo opale countertop is highly resistant to stains, cleaning products and impact. It requires little maintenance. It lasts a lifetime and is also highly attractive. Wall units are immediately overhead, with a Graphic bookcase in-between. It's included to create open compartments.

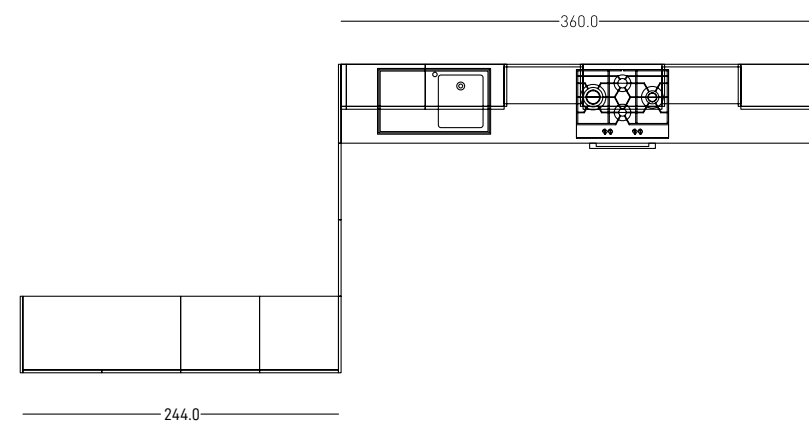

Basi / base units: grigio matt
Schienale / back panel: rovere scott





DOMINO 07

Vuoi rendere più grande una cucina abitabile affacciata sul soggiorno? Sottolinea la continuità dello spazio con scelte coordinate e usa colori neutri. In Domino 07 la penisola delimita la zona della cucina abitabile ed è vestita con entrambe le finiture del melaminico poro aperto opaco usate nell'open space, il rovere bianco e il carbomine. Nel segno della continuità anche le sedie per il tavolo e gli sgabelli per il piano snack in rovere nodato, entrambi modello Tower. Neutra anche la finitura del lavello in Cristadur® Silverstone a vasca unica di ben 72 cm di larghezza e miscelatore con canna alta a ponte e doccetta estraibile. Il lavello è accessorabile con taglieri, cestelli ed eventuali luci a LED.

Do you want to extend a liveable kitchen that faces the living room? Highlight the continuity of the space with coordinated choices and use neutral colours. For Domino 07, the peninsula determines the space of the liveable kitchen area and is available in both matte open pore melamine finishes used in the open space, in rovere bianco and carbomine. For a seamless line, the chairs for the table and the stools for the snack top are also available in rovere nodato, both in the Tower model. The finish for the Cristadur® Silverstone single bowl sink, 72 cm in width is also neutral, with a mixer tap with a high bridge spout and a pull-out spray. The sink can be accessorised with chopping boards, baskets and LED lights.



Basi, pensili e colonne / base, wall and tall units: rovere bianco
Top e schienale / countertop and back panel: carbomine
Piano snack / snack top: rovere nodato
Gola e zoccolo / grip profile and plinth: bianco



DOMINO 07

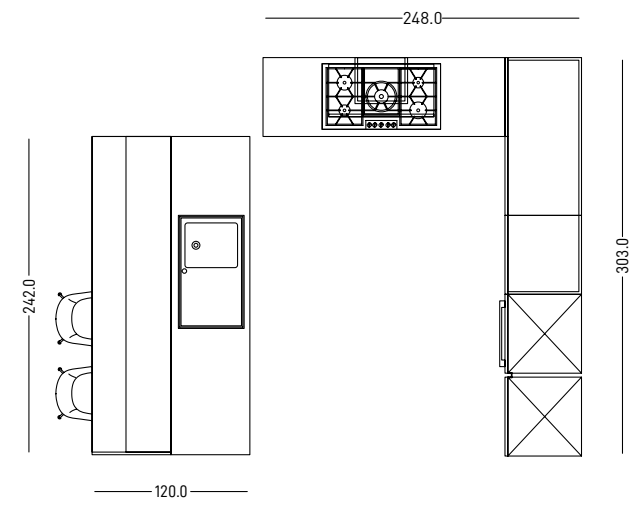

Il piano di lavoro è illuminato dal profilo LED Cut, incassato in orizzontale nella nicchia sotto ai pensili, regolabile in intensità con un interruttore elettronico. Nella pagina accanto, i vani a giorno sottili creano movimento nella composizione perché introducono un cambio netto di colore e materiale.

The worktop is lit by a Cut LED profile, horizontally recessed in the niche below the wall units. It has adjustable intensity with an electronic switch. On the opposite page, open compartments add variety to the composition, as they introduce a distinct change in terms of colour and materials.



Basi / base units: carbomine
Pensili / wall units: rovere bianco
Elementi a giorno / open elements: nero

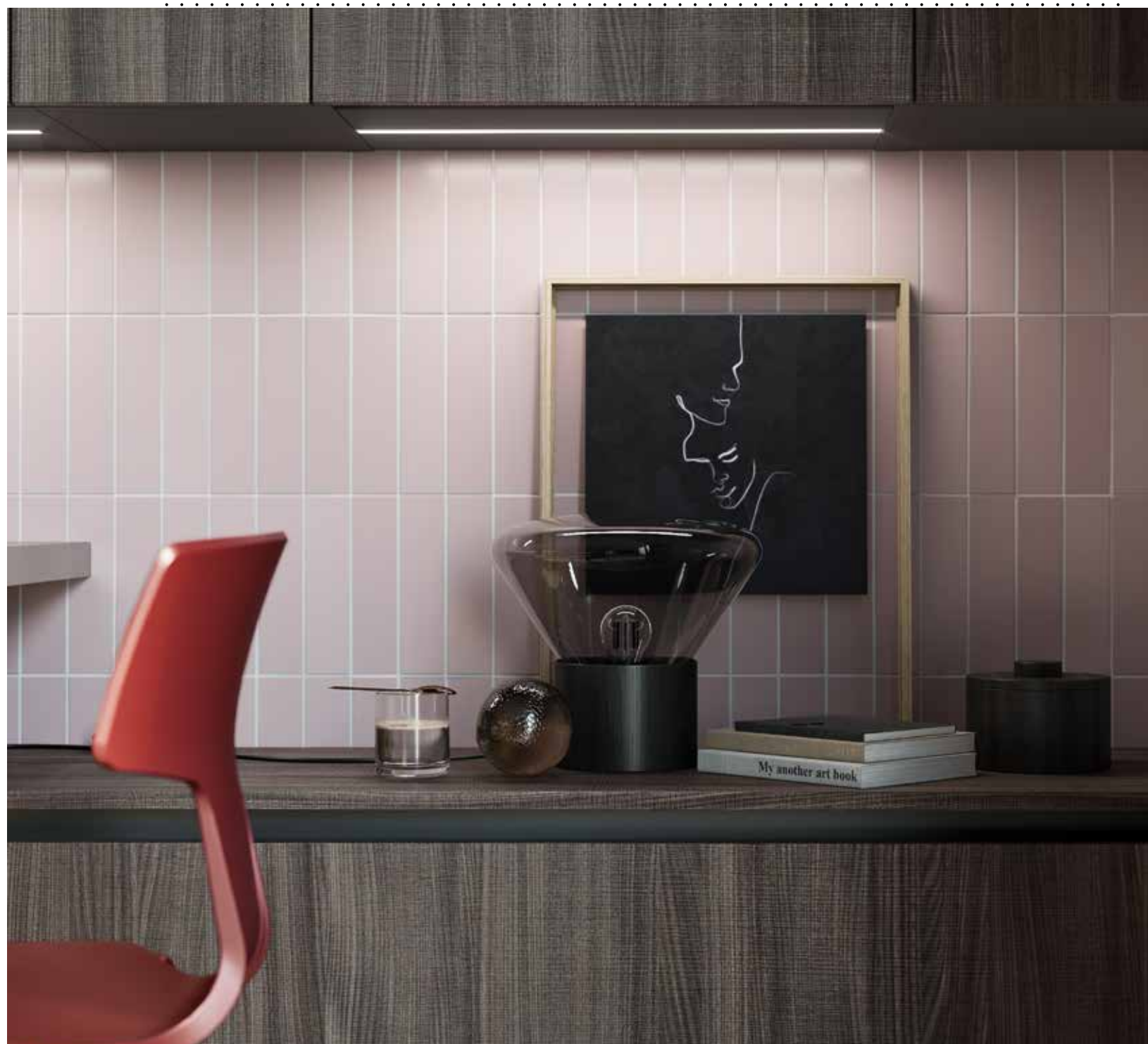

DOMINO 08

L'area centrale lungo la parete pare un monolite, grazie all'uso di schienale a tutta altezza, basi, pensili e top in melaminico poro aperto opaco whitey. Alle estremità, ci sono da un lato gli elettrodomestici nelle colonne, dall'altro pensili e basi sospese in melaminico poro aperto opaco olmo cenere, effetto tranché al tatto, quasi fosse un tronco segato.

Attenzione a mettere tutto nel giusto ordine così puoi cucinare in comodità: spazio dispensa per prendere i cibi, poi lavello, piano di preparazione e sistemi di cottura, infine la zona per i pasti e gli oggetti. Importante anche l'illuminazione. Utile una luce sottopensile a LED, come Cut. Per sfruttare ogni centimetro, usa un tavolo a penisola con supporto Sidney. Qui lo abbiniamo alle sedie Shark, tinta melanzana.

The central area along the wall looks like a single unit thanks to the full-height back panel, base and wall units, and a countertop in matte whitey open pore melamine. At the ends of the composition, the appliances in tall units are on one side, whereas wall units and suspended base units are on the other in matte olmo cenere open pore melamine, with a tactile textured-effect, almost like a sawn log.

Make sure you put everything in the right order so that you can cook easily: with food storage areas within easy reach, then the sink, the countertop for food preparation and the cooking systems, and finally the space devoted to meals and objects. Lighting is also important. An undercabinet LED light, such as Cut is also useful. To exploit every centimetre, use a peninsula table with a Sidney support. Here, we have matched it with melanzana Shark chairs.



Basi e pensili / base and wall units: whitey
 Basi e pensili / base and wall units: olmo cenere
 Colonne / tall units: olmo cenere
 Top e schienale / countertop and back panel: whitey
 Elementi a giorno / open elements: grafite
 Maniglia e zoccolo / handle grip and plinth: piombo



CUCINA LINEARE CON TAVOLO A PENISOLA | LINEAR KITCHEN WITH A PENINSULA TABLE

DOMINO 08

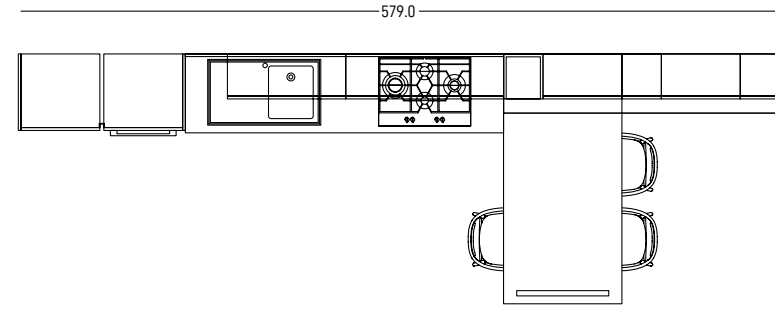

Il lavello è in Cristadur® Nero, molto resistente a urti e calore, naturalmente antibatterico con una texture setosa al tatto e miscelatore in tinta. Piano e ante dei mobili sono in contrasto colore in finitura whitey, usata anche nell'area salotto, con basi sospese che ospitano capienti cestoni.

The sink is made of Nero Cristadur®, which is highly resistant to impact and heat, naturally anti-bacterial, with a silky texture to the touch and a mixer tap in the same colour. The countertop and cabinet doors are in a contrasting colour with a whitey finish. They can also be found in the living room area, with suspended base units that house spacious deep drawers.



Basi / base units: white
Mensole / shelves: olmo cenere



DOMINO 09

Vuoi uno stile più contemporaneo con un gusto industrial? Utilizza entrambe le tipologie di ante Domino! Qui usiamo l'anta liscia per le colonne in resina lava e per i pensili in grafite matt, mentre per le basi in rovere vintage abbiamo l'anta a telaio. Il materiale di tutte le finiture, riprese poi nei mobili del salotto, è melaminico poro aperto opaco.

E la funzionalità? Sempre. Ci sono Stilo, utilizzata come classica libreria dietro al divano, Graphica, trasformata invece in mensole sopra il lavandino, e la comoda colonna ad angolo con il forno. Rende utilizzabile tutto lo spazio: ci accedi dalle ante sopra e sotto l'elettrodomestico e puoi attrezzare i vani con luci e meccanismi interni a estrazione. Completano l'insieme il tavolo Space e le sedie Sammy.

Do you want a more contemporary style with an industrial look? Use both Domino door types! Here, we have used smooth doors for tall units in lava resin, with graphite matt for wall units, whereas base units are in vintage oak, with frame doors. The material used for all the finishes, which are then repeated in the furniture units of the living room, is matte open pore melamine.

And what about functionality? Always present. We have Stilo, used as a classic bookcase behind the sofa, whereas Graphica is transformed into shelves above the sink, and then the handy corner tall unit housing the oven. It makes the entire space usable: you can access it from the doors above and below the appliance, and you can accessorise compartments with lights and internal pull-out mechanisms. The Space table and Sammy chairs complete the overall look.



Libreria / bookcase: Stilo con spalla nera, mensole rovere vintage / Stilo with a black side and rovere vintage shelves

Basi / base units: rovere vintage
Pensili / wall units: grafite matt
Colonne / tall units: resina lava
Top e schienale / countertop and back panel: resina lava
Elementi a giorno / open elements: resina lava e ottanio
Elementi a giorno / open elements: Graphic piombo e rovere vintage
Maniglia e zoccolo / handle grip and plinth: brunito



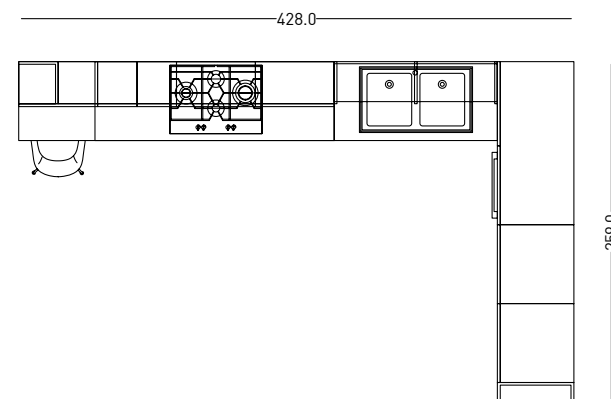

Il lavello a fianco è in Cristadur® Nero con vasca maggiorata del 30% rispetto a quelle standard e gocciolatoio, per un totale di 100 cm.
Il pensile sopra, aperta l'anta, svela due elementi interni separati. Uno è il classico vano interno, l'altro appare come un vano a giorno laterale rispetto ai pensili.

The sink at the side is in Nero Cristadur® with a bowl 30% larger than standard ones, with a drainer, totalling 100 cm.
When the door is open, the wall unit above reveals two separate internal elements. One is a classic internal compartment, the other is an open compartment at the side of the wall units.



PARTE TECNICA

Technical details

**Un mix di finiture che ti permetteranno
di non lasciare nulla al caso.
Scopri le e crea la cucina che hai sempre
desiderato.**

An array of finishes will allow you to curate each single detail.
Explore them all and create the kitchen of your dreams.

DOMINO ANTA LISCIA

Melaminico liscio opaco / Melamine matt plain

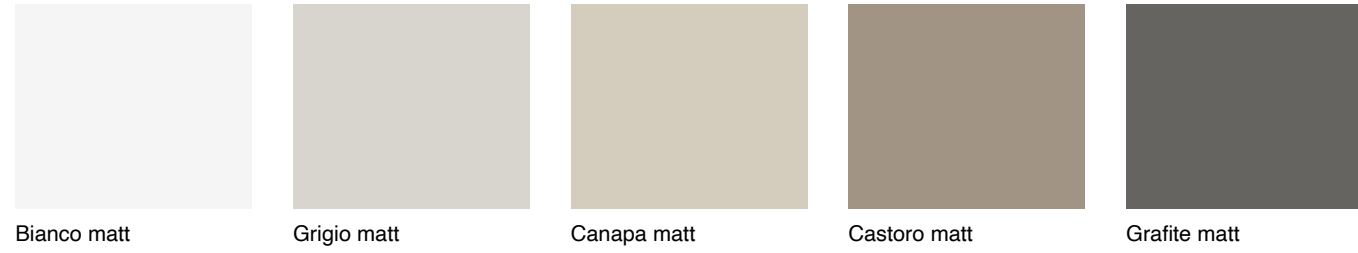

Melaminico poro aperto opaco / Melamine matt open pore



Laccato UV liscio lucido / UV lacquered glossy plain



Melaminico resina opaco / Melamine-faced matt resin

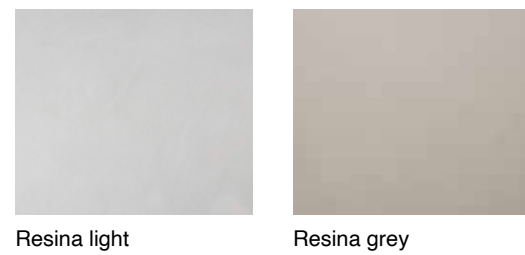

Laccato UV super matt / UV super matt lacquered

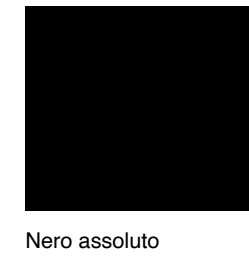
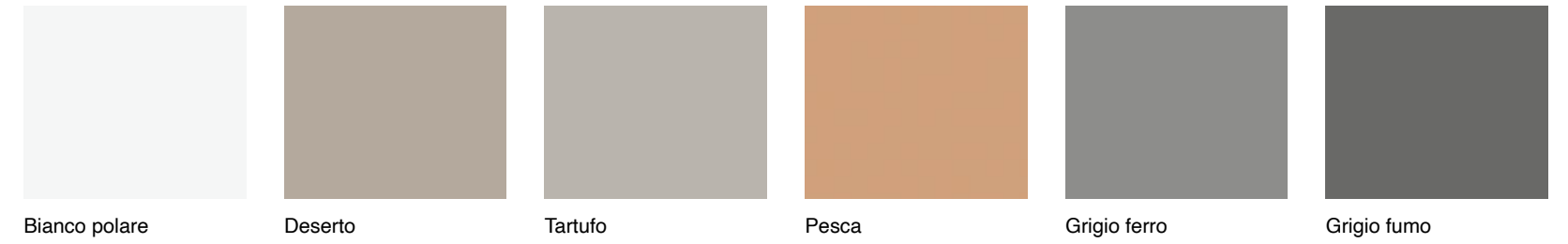

PET liscio opaco / PET matt smooth

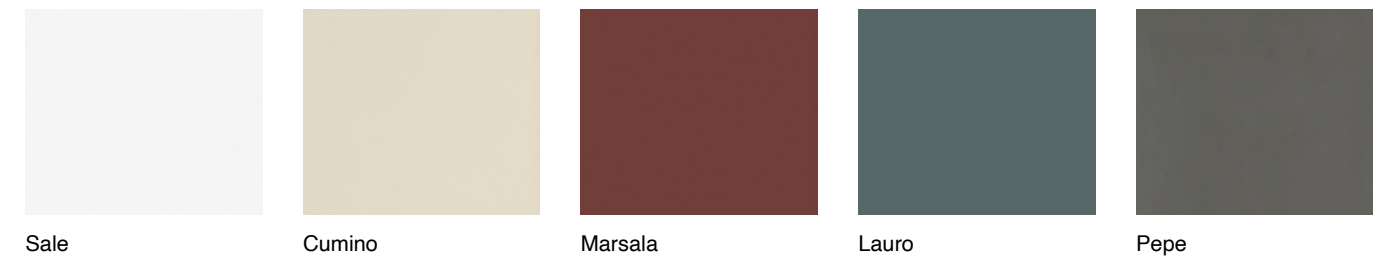

PET resina opaco / PET matt resin

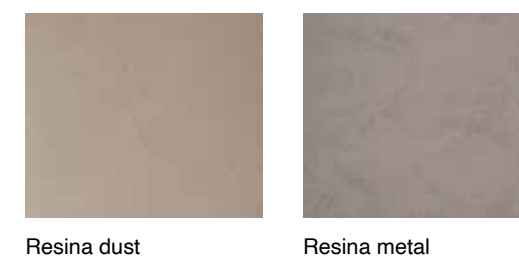

Laccato opaco / Matt lacquered



DOMINO ANTA TELAIO

Melaminico poro aperto opaco / Melamine matt open pore



Larice



Acacia



Rovere vintage



Noce cannella

DOMINO ANTA LISCIA

Sezione anta
Door section

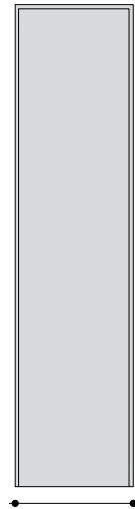

22

Frontale spessore 22 mm realizzata con un pannello di particelle di legno o MDF rivestito in melaminico, laccato o PET. Bordo dritto nei quattro lati.

22 mm thick door panel in wood particleboard or MDF faced with melamine, lacquered or PET. Straight edge on all four sides.

DOMINO ANTA TELAIO

Sezione anta
Door section

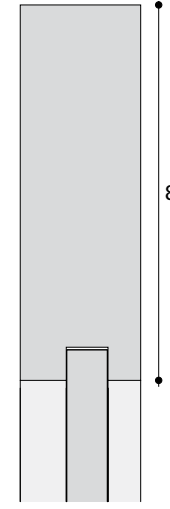

22

80

Frontale a telaio spessore 22 mm in particelle di legno rivestito in melaminico con bordo dritto nei quattro lati.

22 mm thick frame front panel in wood particleboard faced with melamine with straight edge on all four sides.

È espressamente vietata qualsiasi riproduzione, copia o modifica anche parziale, del presente catalogo.
Reproducing, copying or modifying this document, either fully or in part, is expressly prohibited.

L'Azienda si riserva la facoltà di modificare, in qualunque momento e senza preavviso,
le caratteristiche tecniche dei modelli illustrati nel seguente catalogo.
The Company reserves the right to change the technical specifications
of any product figuring in this catalogue at any time and without prior warning.

Prima Cucine S.r.l. a socio unico
via dell'Artigianato, 12
35010 Trebaseleghe (PD)
T. +39 041 5899999 | F. +39 041 5899991
C. F. - P.IVA 04985830282
primacucine@primacucine.it | primacucine.it



P R I M A
C U C I N E